

### Ordering Information

Accessories/hardware:		
P-trap	K-9018	recommended
Falling Water faucet trim with 8-1/4" spout or	K-T196	recommended
Falling Water faucet trim with 10-1/4" spout	K-T198	recommended
Single control ceramic valve*	K-307-K	recommended
Drain or	K-7710	recommended
Grid drain	K-7715	recommended
*Valve must be ordered to complete Falling Water faucet.		

### Product Information

Fixture*:		basin area	water depth
Lavatory		14" x 11"	6-1/4"
Outlet	1-3/4" D.		
* Approximate measurements for comparison only.			

Included Components:	
Adhesive sealant	81489
Cutout template	116616-7

### Installation Notes

Refer to installation instructions included with fixture before beginning installation.

Product does not have an overflow.

**IMPORTANT:** Product rests on countertop. Consider height of product when designing installation.

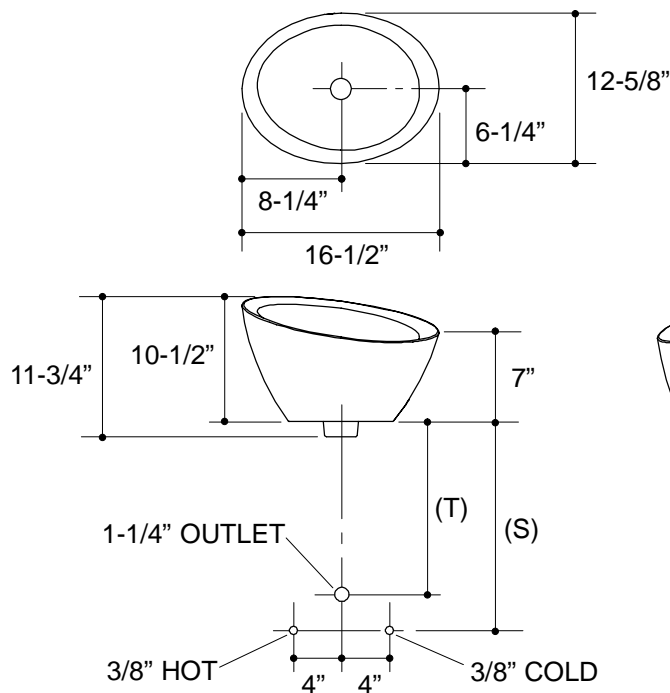

### Roughing-In Notes

Fixture dimensions are nominal and conform to tolerances in ASME Standard A112.19.2M.

(T) Pop-up drain 14-3/8".

(S) 14" (Based on 17-3/4" riser which may require cutting).

Spout must be 8" long (min.) for adequate clearance into lavatory.