

Ordering Information

Accessories/hardware:		
P-trap	K-9018	recommended
Falling Water faucet trim with 210mm spout or	K-T196	recommended
Falling Water faucet trim with 260mm spout	K-T198	recommended
Single control ceramic valve*	K-307-K	recommended
Drain or	K-7710	recommended
Grid drain	K-7715	recommended
*Valve must be ordered to complete Falling Water faucet.		

Product Information

Fixture*:		basin area	water depth
Lavatory		356 x 279mm	159mm
Outlet	Ø44mm		
* Approximate measurements for comparison only.			
Included Components:			
Adhesive sealant		81489	
Cutout template		116616-7	

Installation Notes

Refer to installation instructions included with fixture before beginning installation.
Product does not have an overflow.
IMPORTANT: Product rests on countertop. Consider height of product when designing installation.

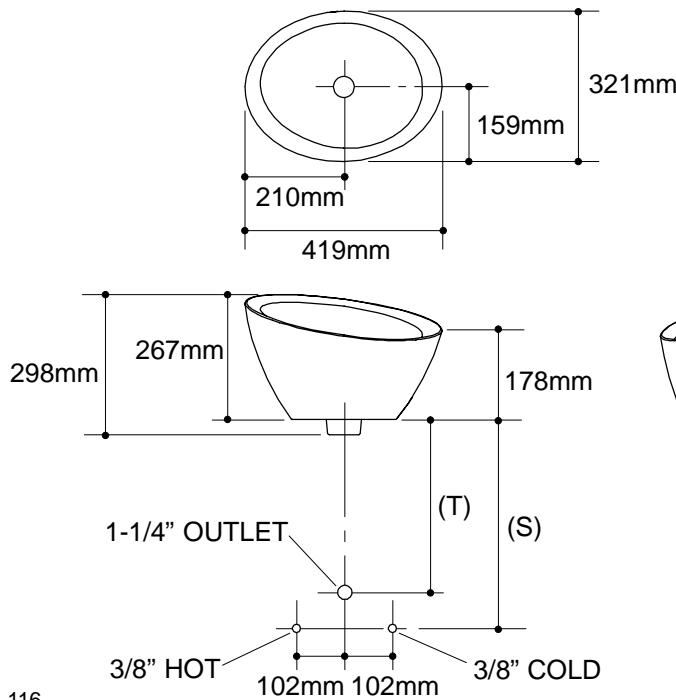

Roughing-In Notes
Fixture dimensions are nominal and conform to tolerances in ASME Standard A112.19.2M.
(T) Pop-up drain 365mm.
(S) 356mm (Based on 441mm riser which may require cutting).
Spout must be 203mm long (min.) for adequate clearance into lavatory.