

**3/4" VOLUME CONTROL VALVE
K-403-K**

FEATURES

- Brass construction
- Wall-mount
- Brass valve body
- 3/4" quarter-turn washerless ceramic disc valve
- 3/4" N.P.T. connections

CODES/STANDARDS APPLICABLE

Specified model meets or exceeds the following:

- ASME/ANSI A112.18.1M
- CSA B125
- IAPMO/UPC

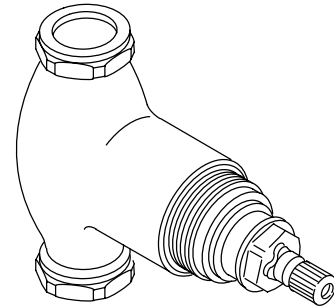

COLORS/FINISHES

- NA Not applicable

SPECIFIED MODEL:

Model	Description	
K-403-K	3/4" Volume Control Valve	<input type="checkbox"/> NA

PRODUCT SPECIFICATION:

Single-handle wall-mount volume control valve shall be of brass construction. Product shall feature a 3/4" quarter-turn washerless ceramic disc valve, assuring positive handle stop positioning. Product shall also feature 3/4" N.P.T. connections. Product is intended for use with K-400-K thermostatic mixer valve. Volume control valve shall be Kohler Model K-403-K-NA.

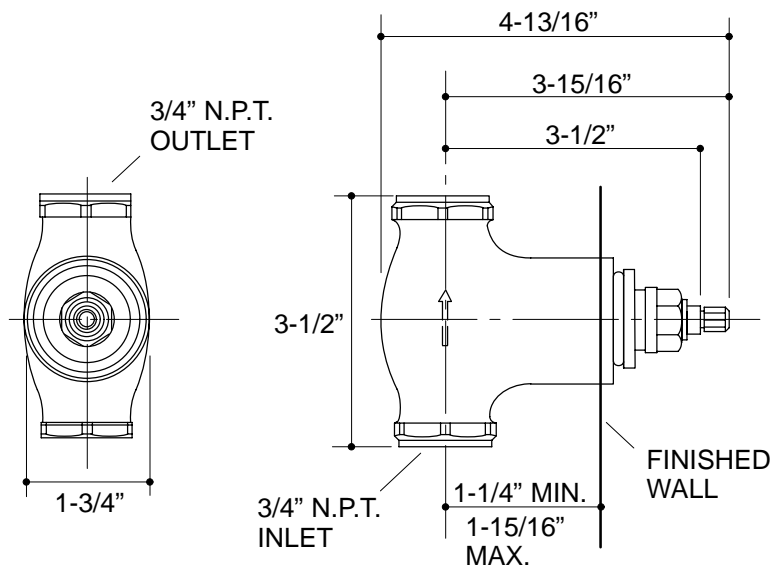

PRODUCT DIAGRAM