

Ordering Information

Applicable product:		
Standard toilet	K-4367	shown
Toilet with bedpan lugs	K-4367-L	not shown
Accessories/hardware:		
Floor bolts (pr.)	21401	recommended
Seat	K-4670-C	recommended

Product Information

ADA compliant.	
Fixture:	
Configuration	Rear spud, elongated
Litres per flush	6 litres*
Spud size	1-1/2"
Passageway	57mm
Water area	289 x 264mm
Water depth from rim	152mm
Seat post hole centers	140mm
* Designed to flush with 6 litres of water when installed with a 6 lpf flush valve.	
Included Components:	
Spud	18357
Bolt caps (pr.)	52048
Flush valve requirements: Refer to manufacturer and local codes.	

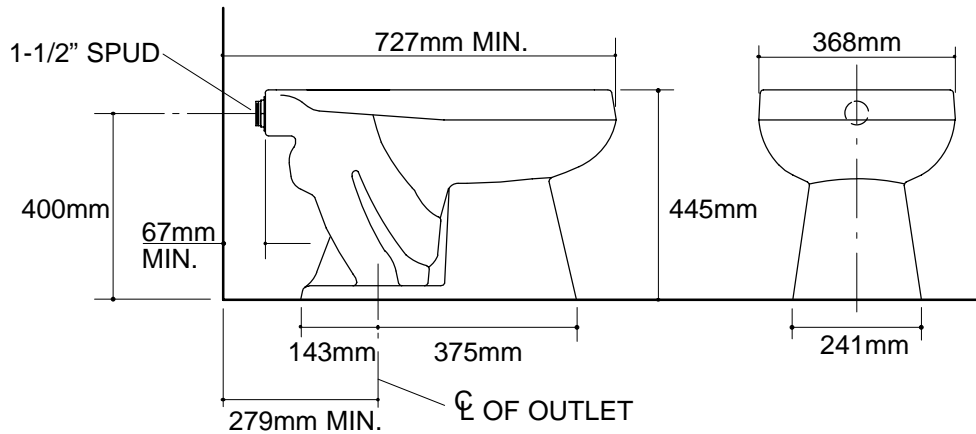

Roughing-In Notes
Fixture dimensions are nominal and conform to tolerances in ASME Standard A112.19.2M.