

**Ordering Information**

Accessories/hardware:		
3/8" supply	K-7637	recommended
Floor bolts (pr.)	21401	recommended
Seat	K-4652	recommended

**Product Information**

Fixture:	
Configuration	2-piece, elongated
Gallons per flush	1.6 gallons
Passageway	2"
Water area	10-7/8" x 9"
Water depth from rim	6"
Seat post hole centers	5-1/2"
Included Components:	
Bowl	K-4276
Tank	K-4447
Tank cover	84274
Trip lever	77785

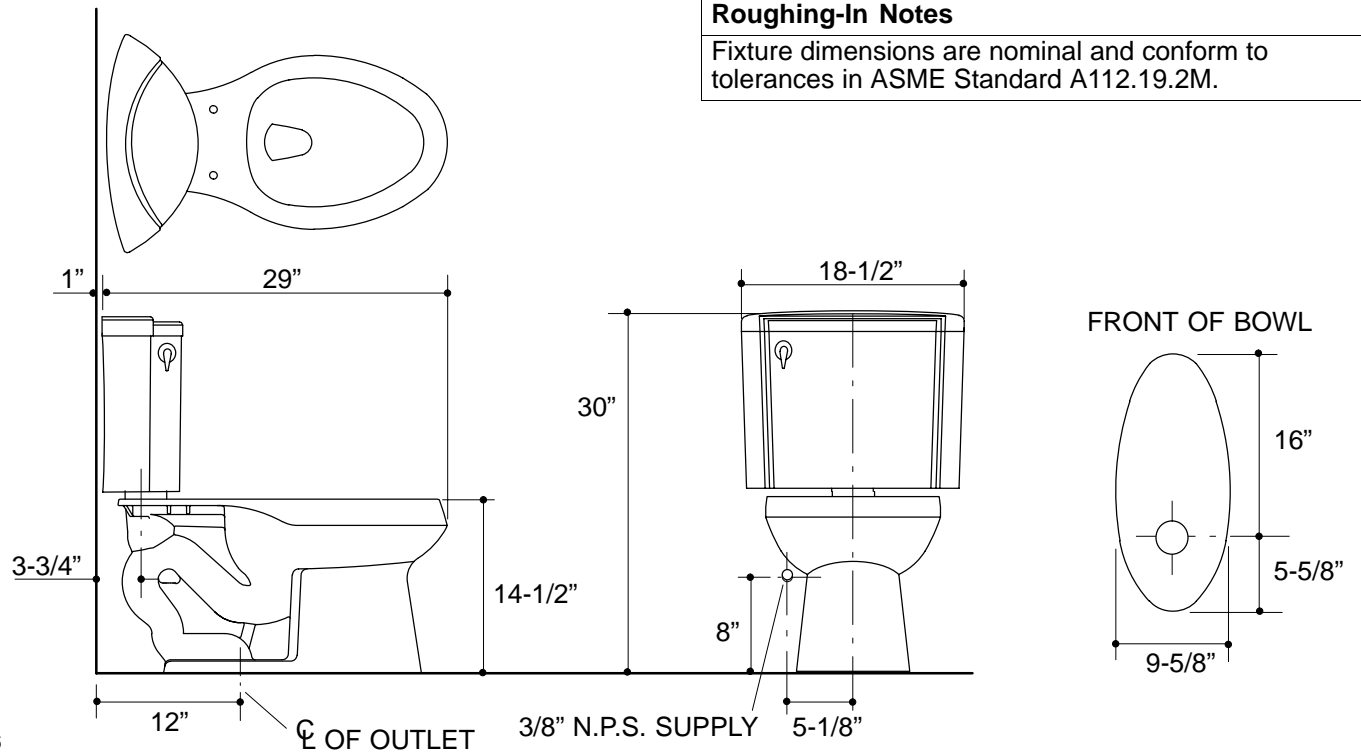

**Roughing-In Notes**  
Fixture dimensions are nominal and conform to tolerances in ASME Standard A112.19.2M.