

Ordering Information

Accessories/hardware:		
Bottom basin rack	K-6013	optional

Product Information

Fixture*:		basin area	water depth
Sink		22" x 18"	8-5/8"
Outlet	3-5/8" D.		
* Approximate measurements for comparison only.			

Roughing-In Notes

Fixture dimensions are nominal and conform to tolerances in ASME/ANSI Standard A112.19.2M.

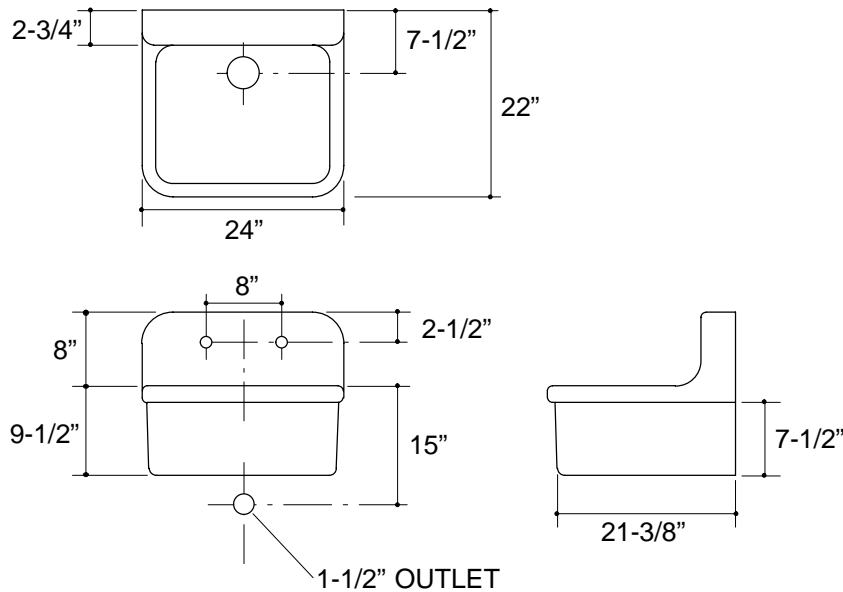

.7<116