

1-INNER & OUTER SKID  
DETAIL @ EVERY JOIST

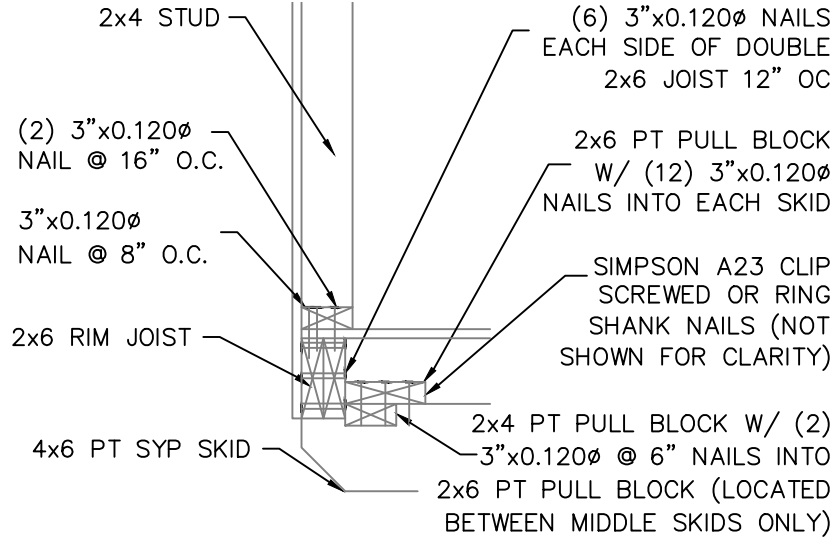

2-ENTRY DOOR ENDWALL JOIST DETAIL

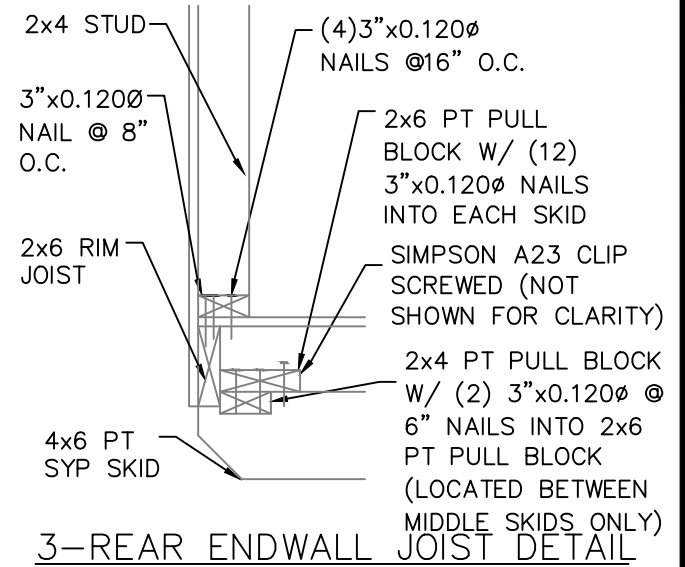

3-REAR ENDWALL JOIST DETAIL

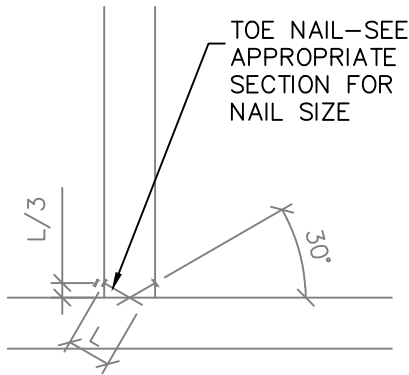

4-TOE-NAIL DETAIL

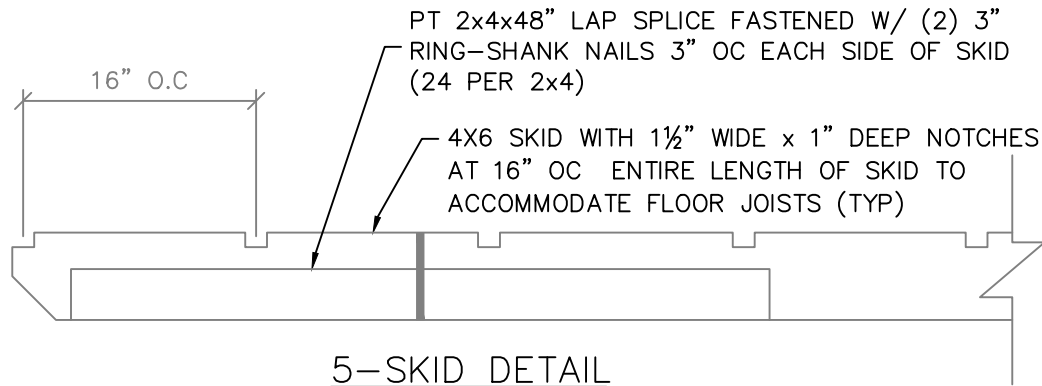

5-SKID DETAIL

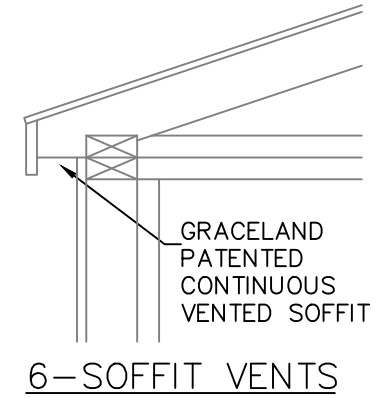

6-SOFFIT VENTS



**S.O.S. PORTABLE BUILDINGS**

890, I-10 SERVICE RD, SLIDELL, LA 70461

BUILDING SIZE:	30X50	DATE:	01-04-2022
DRAWN BY:	TT	SCALE:	NTS

DRAWING NUMBER:

**S-109**

UTILITY-LA-V=150MPH-IBC2015

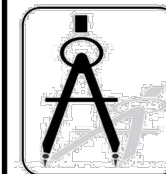

**DAMMON ENGINEERING, INC.**

554 Old Spanish Trail Slidell, LA 70458 (985) 649-5832

Chief Engineer: Brian Mistich, PE  
554 Old Spanish Trail  
Slidell, LA 70458

www.dammonengineering.com  
info@dammonengineering.com  
PHONE: 985-649-5832