

DESIGN SUMMARY PACKAGE COMMERCIAL SEWERAGE FACILITIES 3000 GPD and LESS

(Fill Out Applicable Sheets)

Project:	Elks Lodge # 2321		
Contractor:	Ej Breaux Contractors LLC		
Telephone:	985-252-6183		
Parish:	St. Tammany	Nearest Town:	Slidell
Population Served:	Elks' Lodge, RV Parking, Snack Bar & Reception Hall		
New System? <input checked="" type="checkbox"/> Yes <input type="checkbox"/> No		Existing System? <input checked="" type="checkbox"/> Yes <input type="checkbox"/> No	
Project to be Owned and Operated By: <small>(include name and address)</small>	Slidell Elks' Lodge #2321		
	34212 Elks' Road Slidell LA 70480		
	James Crippin, 985-641-1266		
	jimmycrippin@yahoo.com		
Proposed Project Will Tie-in to:	Sewer:	parish drainage	

EXTENDED AERATION SEWAGE TREATMENT FACILITY

1 of 3

Project:	Elks' Lodge # 2321			Water Well within 100'?
Contractor:	EJ Breaux Contractors LLC			
General Scope of Project:	Replace existing wastewater treatment plant			
				<input type="checkbox"/> Yes <input checked="" type="checkbox"/> No
Design Average Flow:				
BOD ₅ Loading (in lbs of BOD ₅ per day):				
Max. # of Lots or Population at Maximum Capacity:				
Initial # of Lots (or population):				
Industrial Waste:	not applicable			
Design Effluent Limits:	BOD ₅ : 20	TSS: 20	NH ₃ N: 5	
RECEIVING STREAM: <small>(provide complete path from outfall to first perennial non- intermittent waterway in the path of the projected outfall.)</small>	Parsih drainage ditch			
	Bayou Liberty			
Plant Manufacturer:	EJ Breaux Contractors LLC			
Plant Model #:	EJBC2.0C			
Materials of Construction:	Concrete			
AERATION TANK	Volume:	2000		
	Retention Time <small>(24 Hour Min):</small>	24		
	BOD ₅ Loading: <small>(lb per 1000 CF, 12.5 max.)</small>	3.40		
	Screen or Communtor?	<input type="checkbox"/> Yes <input checked="" type="checkbox"/> No		
FINAL CLARIFIER	Surface Area:	22.75		
	Surface Loading: <small>(gpd/ft² @ peak hourly flow)</small>	90		
	Volume:	250		
	Scum Baffle:	Yes		
	Skimmer Through:	No		
	Weir Loading: <small>(gpd/ft @ peak hourly flow)</small>	400		
NAME OF CERTIFIED OPERATOR:	G René Landry #57072			

**EXTENDED AERATION SEWAGE
 TREATMENT FACILITY**

2 of 3

AIR SUPPLY	# of Blowers:	one	
	Capacity of Each (SCFM):	48	
SLUDGE RETURN	Method:	Air lift pump	
	Maximum Flow (GPM):	30	
	Maximum Percent (% of DAF):	100	
SLUDGE DRYING BEDS	Number of Beds:	not applicable	
	Area of Each Bed:		
	Total Area:		
	Area per Capita:		
	Gravel Layer Depth:		
	Sizes:		
	Sand Depth:		
	Under-drain Size:		
	Freeboard Above Sand:		Splash Plate?
	Effluent To:		<input type="checkbox"/> Yes <input type="checkbox"/> No
SLUDGE LAGOONS	Number of Lagoons:	not applicable	
	Maximum Depth:		
	Free Board:		
	Volume of Each Lagoon:		
	Volume of Each Lagoon per Capita:		
	Pump:		
	Piping Material:		Size:
	Effluent To:		
OTHER SLUDGE DISPOSAL METHODS Explain:	System to be pumped by licensed hauler once DAF meets or exceeds 50%		

**EXTENDED AERATION SEWAGE
TREATMENT FACILITY**

3 of 3

CHLORINATION	Number:		one	
	Gas or Hypo:		hypo	
	Capacity (lb per 24 hrs):		6	
	Test Kit:		not applicable	
	Location:		inline	
	Ventilation:		open grating	
CHLORINE CONTACT TANK	Inside Dimensions	Length:	36"	
		Width:	36"	
		Operating Depth:	23"	
	Capacity (gal):	125		
	Retention Time: <small>(15 minute min. @ peak hourly flow or maximum rate of pumping)</small>		90	
Baffles? <input type="checkbox"/> Yes <input checked="" type="checkbox"/> No		Scum Baffle? <input type="checkbox"/> Yes <input checked="" type="checkbox"/> No		
ADDITIONAL DETATILS	Power Supply (Dual)? <input type="checkbox"/> Yes <input checked="" type="checkbox"/> No	Washdown Facility? <input checked="" type="checkbox"/> Yes <input type="checkbox"/> No	Backflow Prevention? <input checked="" type="checkbox"/> Yes <input type="checkbox"/> No Type: RPZ	
	Facility Fenced? <input checked="" type="checkbox"/> Yes <input type="checkbox"/> No	Gates Locked? <input checked="" type="checkbox"/> Yes <input type="checkbox"/> No	Access Road? <input checked="" type="checkbox"/> Yes <input type="checkbox"/> No	
Copy of DEQ Administrative Completeness Determination Letter or Discharge Permit attached?				<input checked="" type="checkbox"/> Yes <input type="checkbox"/> No
ADDITIONAL COMMENTS				
LOCATIONAL INFORMATION	Coordinates:			
	Latitude		30° 18' 03.0"N	
	Longitude		89° 49' 04.0"W	
	OR			
Latitude		°N		
Longitude		°W		
Geographic Datum:				NAD83 <input type="checkbox"/> WGS84 <input type="checkbox"/> NAD27 <input type="checkbox"/>
Collection Method:				GPS <input type="checkbox"/> — DGPS/WAAS enabled? Yes <input type="checkbox"/> No <input type="checkbox"/> — Horizontal Accuracy? _____ meters
Map <input checked="" type="checkbox"/> Specify: <u>Google Maps</u>				Scale: _____

EJB Commercial Systems
3153 Hwy 70 S Pierre Part, LA 70339
Phone: 985-252-6183

Concrete Sewage Treatment Systems

General

The wastewater treatment plant shall be an EJ Breaux Commercial Systems, model EJBC 2.0C prefabricated concrete package plant as manufactured by EJ Breaux Commercial Systems, Pierre Part, Louisiana. The wastewater treatment system shall be of the activated sludge type specifically known as “extended aeration” designed for treating a total of 2,000 gallons per day of 210 PPM-BOD5 maximum, domestic sewage based on composite sewage samples of the average daily flow. The complete system shall include all necessary equipment for the efficient plant operation. The system shall be factory assembled so as far as possible, with all piping and controls.

Influent Characteristics

The system shall be capable of treating 2,000 gallons per day of raw domestic sewage, having a maximum organic strength of 210 PPM (BOD5), and 210 PPM suspended solid. No substance shall be introduced in quantities, which are toxic to biological organisms. The plant shall be designed to handle average daily flow rates not to exceed 250% of the design flow.

Tank Construction

All tank vessels shall be fabricated with 4,000 psi concrete with rebar & 6” wire mesh. All walls shall be continuous and water-tight and shall be supported by a structural reinforcing member where required.

All tank piping shall be schedule 40 galvanized steel and \ or PVC.
The system shall be transported to the job site in one section.

Influent Connection

The influent connection shall be one four-inch FNPT collar.

Aeration Chamber

There shall be an aeration chamber to work in conjunction with the clarifier chamber. The aeration chamber shall conform to the following specification: The aeration shall be of sufficient capacity to provide a minimum of 24 hours retention of the average daily flow, and/or a minimum of 1.98 cubic feet per pound of BOD5 of applied loading. The vessel shall be so shaped on each side to prevent sludge accumulation, to enhance rotation of the vessel contents, and to prevent scum and froth accumulation.

To insure maximum retention and eliminate short circuiting of raw sewage particle, the aeration chamber shall be constructed with air diffusers placed longitudinally along one side of the chamber so as to, in conjunction with the flow control baffles, enhance the spiral rotation of the chamber content. To insure adequate circulation velocity the proportion of chamber width to depth, in the direction of rotation of the chamber content, shall not exceed 1.33 to 1. The velocity of rotation shall be sufficient to scour the bottom and prevent sludge filleting as well as to prevent the escape to the surface of minuscule air diffusion bubbles and so causing their entrapment to provide maximum oxygenation efficiency. An air distribution manifold shall be installed longitudinally on one side of the tank with diffuser drop

assemblies connected there to. Each diffuser drop assembly shall be equipped with an air regulating and/or shutoff valve, a disconnecting union and a diffuser bar with air diffuser nozzles minimum air velocity shall be maintained to insure efficient velocity of self-cleaning. The diffusers shall be parallel to, and near the base of the vessel side wall, and at an elevation which will provide the optimum diffusion and mixing of the vessel content. The oxygen transfer capacity detailed in the aeration chamber will be designed to meet treatment requirements of the design sewage load.

Clarifier Chamber

There shall be a clarifier chamber to work in conjunction with the aeration chamber of that system. The clarifier shall conform to the following specification: The clarifier chamber shall be of such as to provide a minimum of four hours retention, based upon the same design flow rate governing the aeration chamber, but including adjustment of such rate to compensate for run-off period, and shall have proper baffling to prevent short circuiting and to provide maximum uniform solids settling areas. The bottom of the chamber wall shall be formed into an inverted pyramidal hopper or hoppers. The flat bottom area of each hopper shall not exceed one square foot. The slope of the hopper walls shall not be less than 1.7 vertical to 1.0 horizontal. Settled sludge shall be returned from the clarifier sludge hopper to the aeration chamber by the positive sludge return system, consisting of one air-lift pump. The clarifier effluent shall pass over the edge of the baffled adjustable trough and then out of the chamber.

Outlet Connection

The plant discharge connection shall be one four- inch FNPT collar.

Air Supply Blower Motor Units

A total of one positive displacement blower motor unit shall be supplied, capable of providing a minimum of 2,100 cubic feet of air per pound of BOD5 delivered, and/or a minimum of 3 CFM per lineal foot of aeration tank length to meet the air requirement of the total system. The blower shall be capable of delivering 48 CFM when operating at 2.4 PSI. The blower shall be manufactured by Sutorbilt. The Model number of the blower is Sutorbilt Legend 2LP RHX LS SPL. The motor shall be 2hp for operating on 230 volts ac single phase, 60 cycles and 3450RPM. It shall be of the totally enclosed, fan cooled type. Each blower shall be mounted on an adjustable base. The base structure shall be adequately reinforced to support the blower and motor unit. For easy adjustment of the "V" belt drive connection between the blower and motor, the motor will be furnished with an adjustable motor mounting base. The blower shall be fitted with a dry type air filter-silencer at the air intake. The blower discharge shall be fitted with a check valve when required, and a flexible rubber discharge coupling. Each blower and motor shall be enclosed with a weatherproof enclosure. The hood is designed for easy access to service the unit. It shall be equipped with a lifting handle and locking devise. All enclosure surfaces shall be properly prepared in a neat manner to obtain a smooth, clean and dry surface. To help reduce blower vibration and noise the blower motor enclosure shall be mounted on vibration dampers. For purpose of the blower performance and/or diffuser condition, a pressure relief valve and pressure gauge shall be mounted in the air manifold.

Electrical Control Center

An electrical control panel shall be installed within a weatherproof enclosure, and shall be provided for mounting as indicated on the plans. The enclosure shall be equal to NEMA type 3-R. The electrical controls shall consist of magnetic starters, program timers, and switches necessary to automatically and manually control all electrical devices and/or motors in the sewage treatment system. The blower motor shall be controlled by selector switches and magnetic starters in conjunction with the program timer. The

program timers shall have the capability to operate the treatment system when required and as determined by the variations in the daily flow rate. All electrical equipment and circuitry shall be protected by properly sized circuit breakers or fuses. All duplex or standby equipment shall be designed so that it may be operated by devices within the control system. All wire and conduit required between the control panel and the electrical power service shall be furnished and installed by the purchaser. Wiring and conduit between the control panel and plant equipment shall be furnished by the manufacturer of the waste water treatment plant. The panel may be detached for shipping. The main power supply to be furnished by the customer shall be 230 volts ac, singles phase, at 60 cycles.

Chlorinator

A chlorine chamber, when required, shall be furnished with a baffled chamber, constructed integrally with the clarifier designed to provide disinfection of the secondary effluent. The tank shall be sized for a capacity of 125 gallons. Baffles shall be provided to eliminate short circuiting and shall be designed to keep floating material from leaving the chamber. Sufficient flow baffles will be supplied to assure proper mixing of the chlorine solution with the plant effluent. The chlorination equipment shall consist of a Norweco chlorinator model LF1000. The chlorinator shall have the capacity of disinfecting the effluent from the treatment system.

Sludge Re-circulation System

There shall be installed within the clarifier chamber(s) a positive sludge return system, consisting of one 2- inch diameter airline sludge return assembly(s) meeting the following specifications: The airlift system shall have the re-circulation capacity ranging from 0% to 150% of the design flow. The airline supplying air to the system shall be equipped with a valve to vary the return capacity of the system. The airlift system shall be firmly supported and shall be equipped with a clean out plug to allow cleaning and maintenance.

Scum Re-circulation System

There shall be installed within the clarifier chamber a positive scum and skimming re-circulation system consisting of one airlifting skimming devices meeting the following specifications: The skimming device shall be of the positive airlift type, located in a position to skim and return floating material to the aeration chamber. The air-line supplying air to the skimming device shall be equipped with a valve which will enable adjustment of the return flow rate. There should be an adjustable skimmer head for exact positioning of the skimmer head at water level.

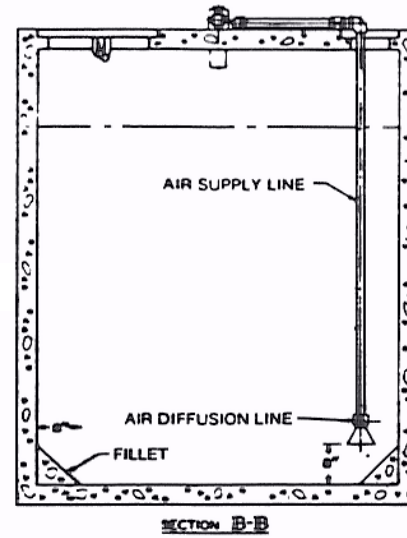
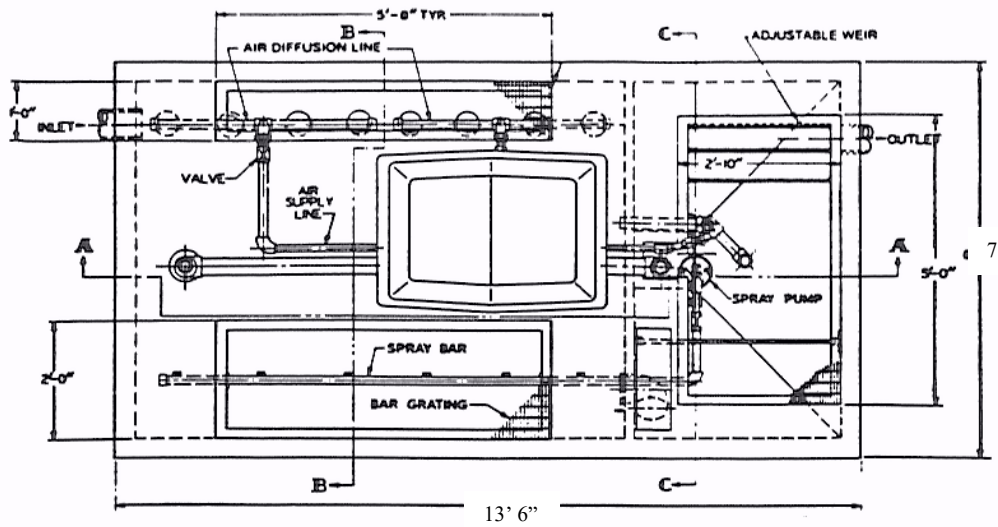

NOTE:
TO MINIMIZE FALL THRU PLANT,
LOCATE INLET INVERT 6" ABOVE
FLOW LINE.

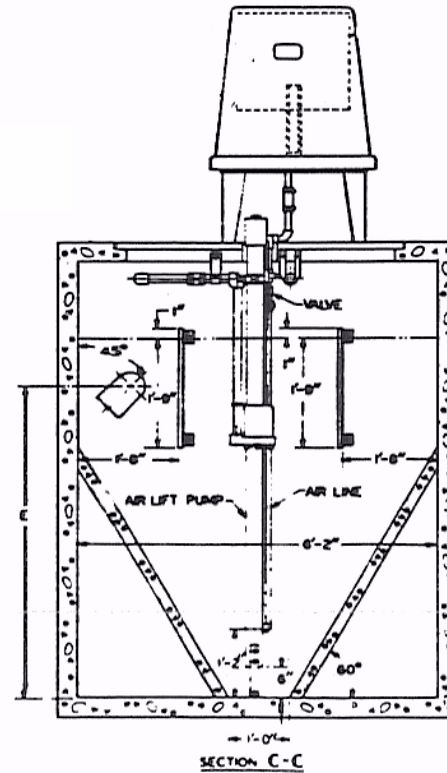
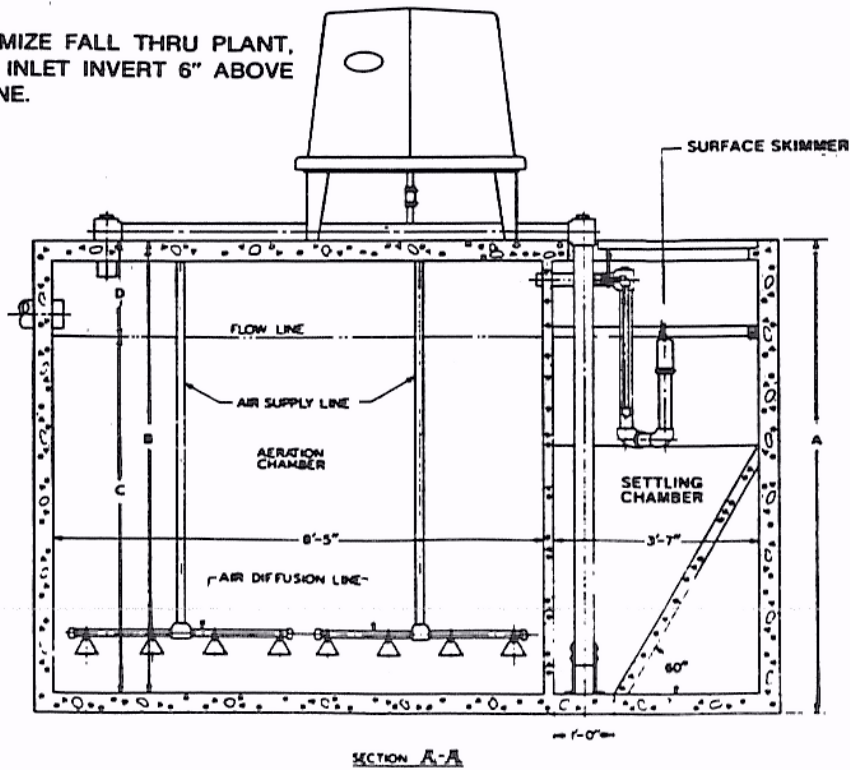

Design Data:
 Design Volume: 2000 g.p.d.
 Biological Loading: 3.4 lbs @ 200ppm
 Blower Make: Republic
 Model: HRC201
 HP: 1.5
 CFM: 75
 PSI: 2
Aeration Zone:
 Volume: 2000 Detention: 4hrs
 Raise Rate: 113 gpd/sf
 Weir Rate: 83.3
 Chlorine Tank: (not shown)
 Volume: 125 gallons
 Detention at Avg Flow: 90 min
 Chlorinator Make: Norweco
 Model: LF1000
 Air Drop lines: 2
 Total Diffusers: 8
 Inlet and Outlet Lines Size: 4

Plant Size: A 8'-2"
 B 7' 10"
 C 4' 8"
 D 3' 2"
 E 3' 10"

Model Number: EJBC2.0
 Drawing number: B-1

EJ Breaux Commercial Systems
 985-252-6183

125 gallon Chlorine Contact Chamber

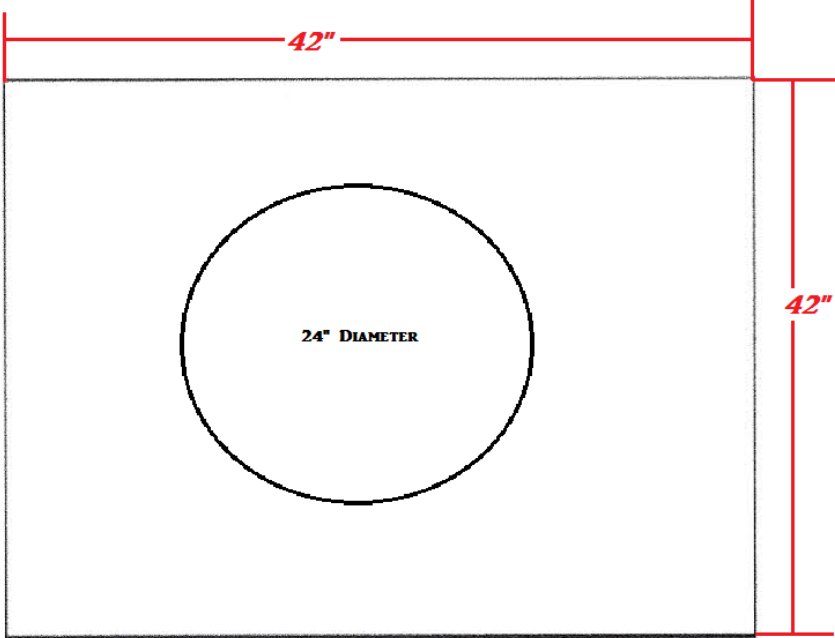
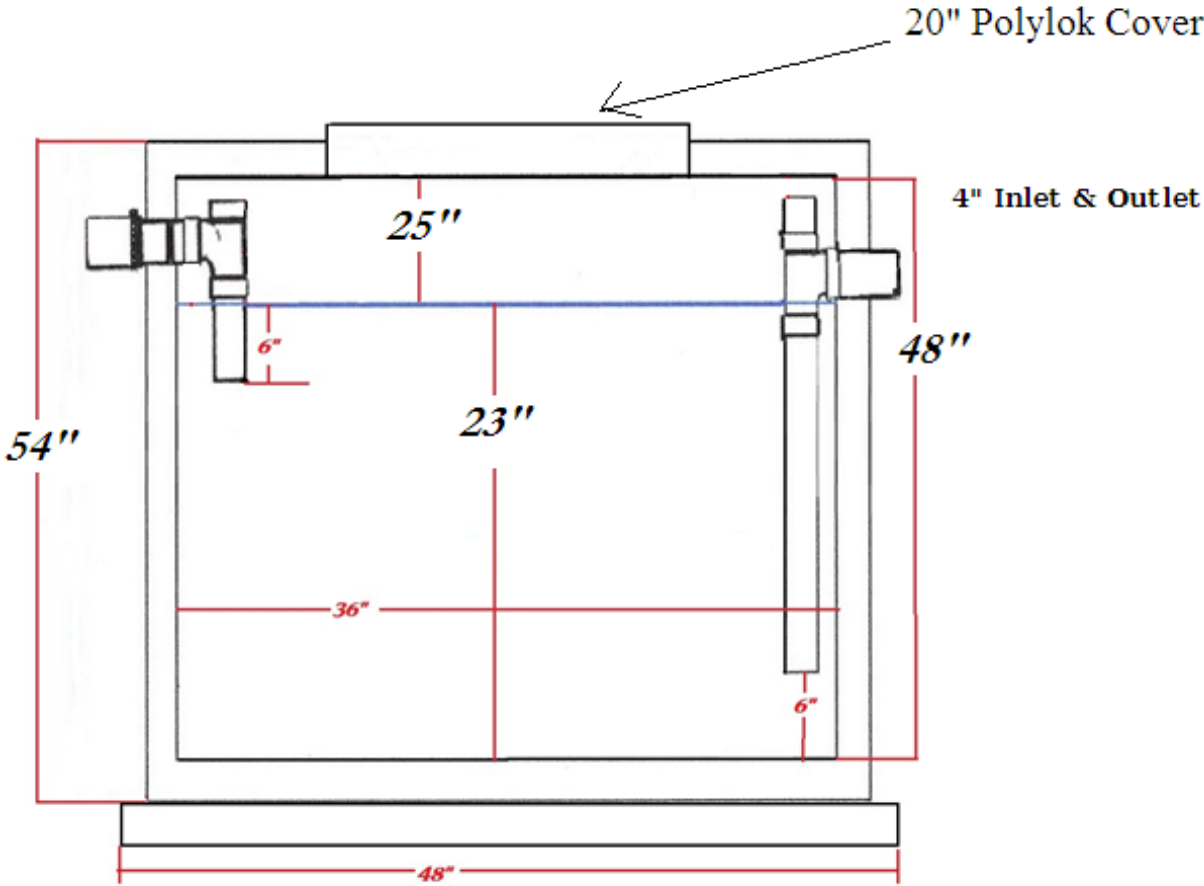

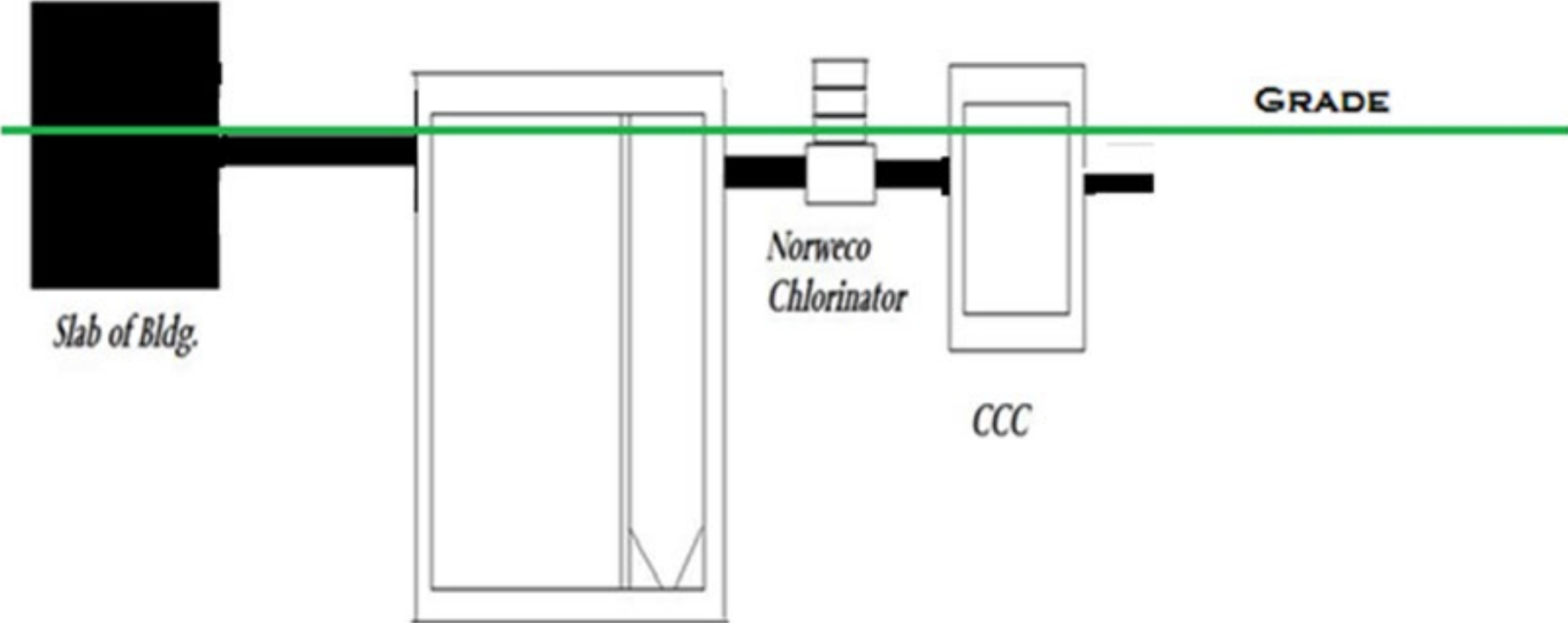

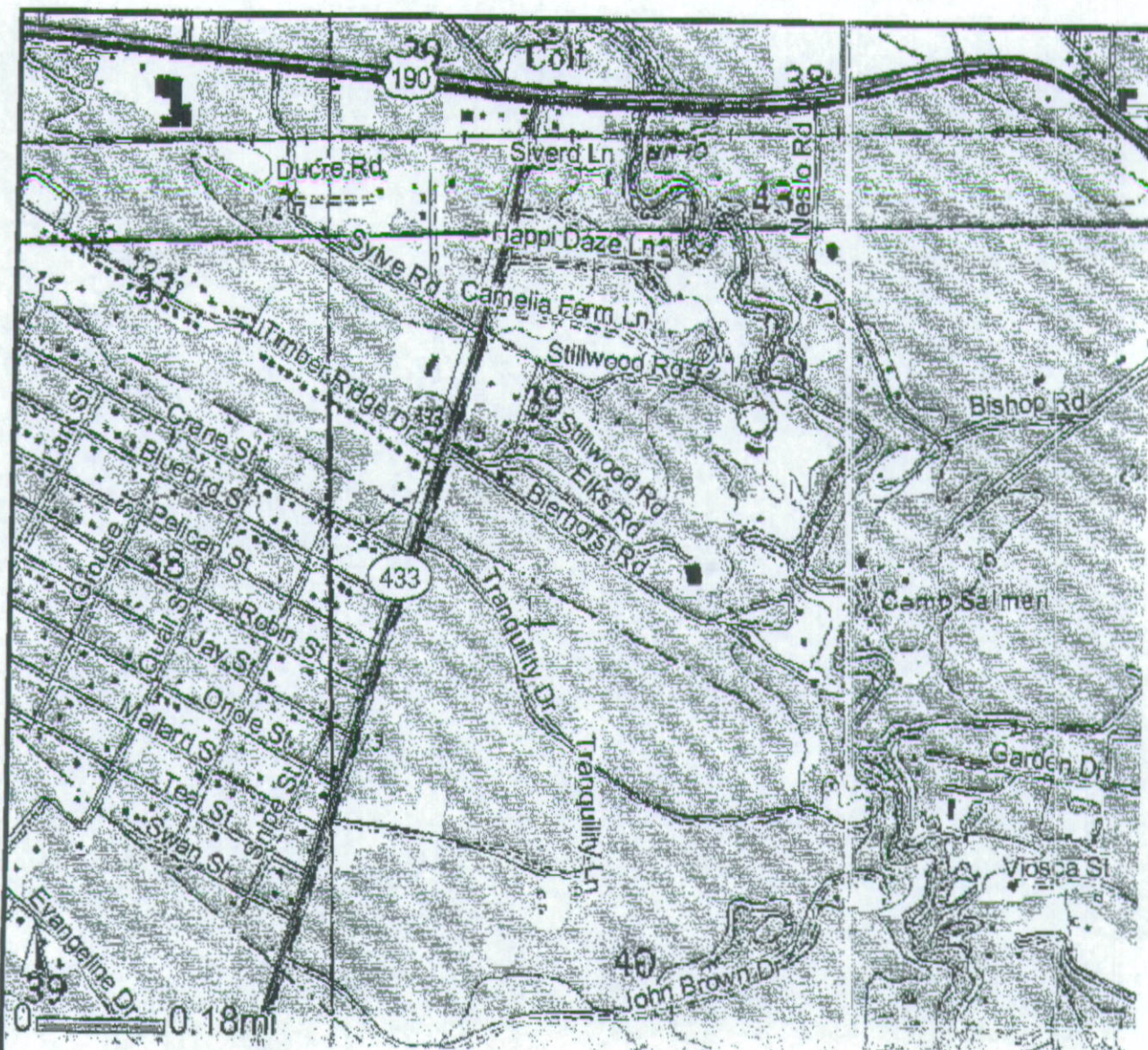

April 24, 2008



LDEQ Disclaimer:
 The Louisiana Department of Environmental Quality (LDEQ) has made every reasonable effort to ensure quality and accuracy in producing this map or data set. Nevertheless, the user should be aware that the information on which it is based may have come from any of a variety of sources, which are of varying degrees of map accuracy. Therefore, LDEQ cannot guarantee the accuracy of this map or data set, and does not accept any responsibility for the consequences of its use. Source: LDEQ GIS Center Make-A-Map (<http://map.ldeq.org>)



All American Lodge Greatest in Elkdome AI# 157925

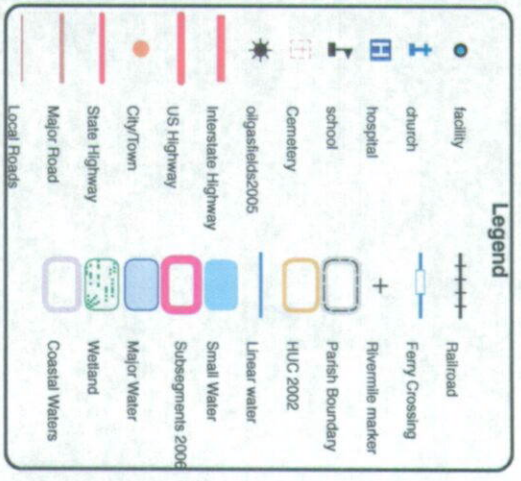
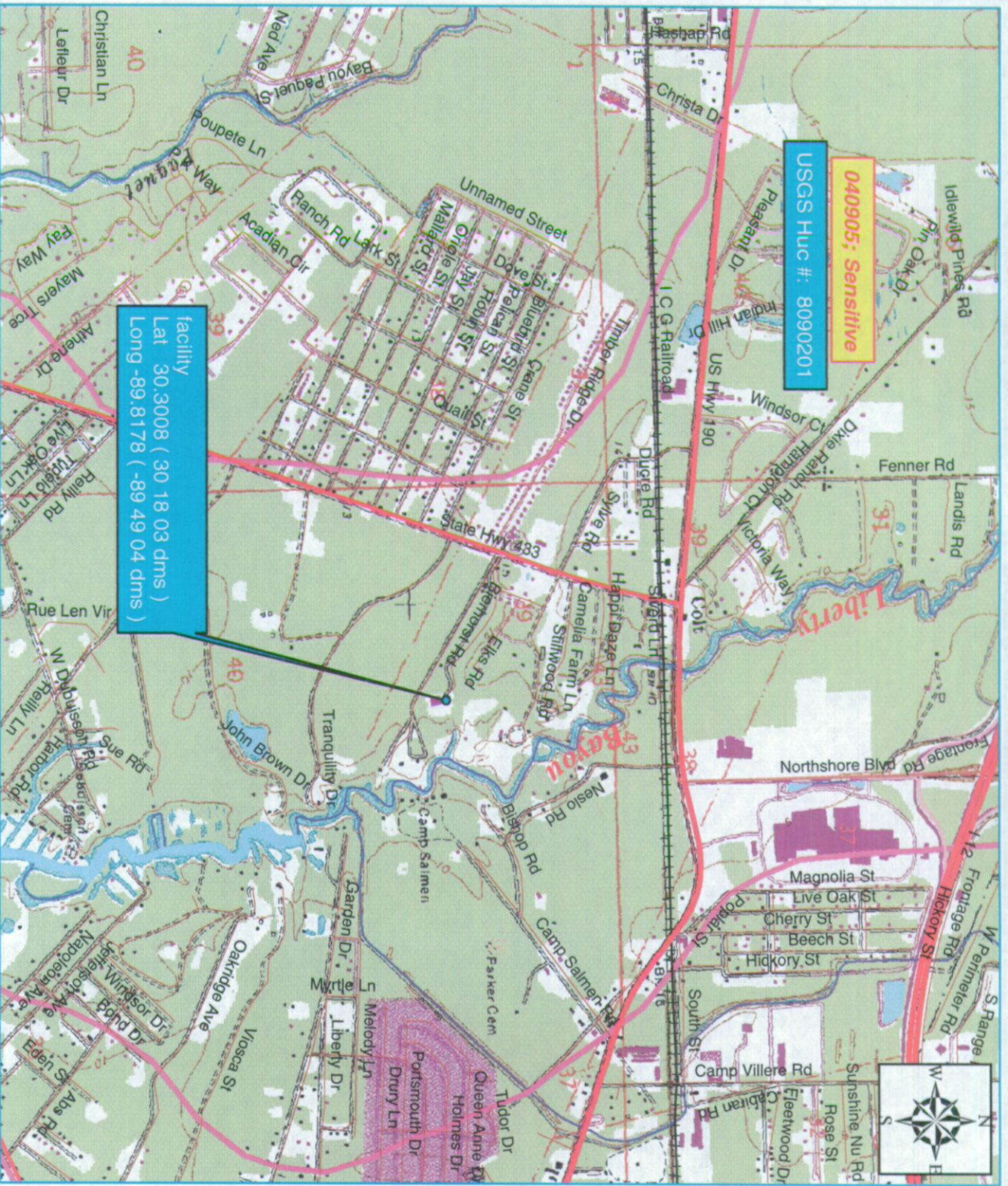

LDEQ Disclaimer:
The Louisiana Department of Environmental Quality (LDEQ) has made every reasonable effort to ensure quality and accuracy in producing this map or data set. Nevertheless, the user should be aware that the information on which it is based may have come from any of a variety of sources, which are of varying degrees of accuracy. Therefore, LDEQ cannot guarantee the accuracy of this map or data set, and does not accept any responsibility for the consequences of its use.

Creation Date: June 5, 2008; MAP# 2008-02-154; Created By: Debbie Bissell
Data Sources: Sites provided by All American Lodge Greatest in Elkdome; 2002 USGS HUC; 2004 LDEQ Subsegments; 2000 Census Tract/Line Roads; 1999 ESRI Places; 1999 LDOITD Parish Boundaries; 1999 ESRI/GDT Waterbodies; 1998 USGS GNIS Community/Airport/Cemetery; Wetlands from USGS 1:100000 DLGs; 1:24000 USGS DRGs; 1996 LAC 33:IX Chapter 23; 1999 Lakes and Mississippi River digitized from USGS 1:24000 DRGs; 1996 LADEQ Water Quality Inventory
This map is intended for LDEQ internal use only.