

**LAVATORY BASE FAUCET  
K-7444-K**

**FEATURES**

- Brass construction
- Flexible connections
- Brass valve bodies
- Quarter-turn washerless ceramic disc valves
- 5" spout
- Available with standard or vandal-resistant Water-Guard® aerator
- 2.0 gallons per minute
- Chain and stopper drain
- Variety of handle style options

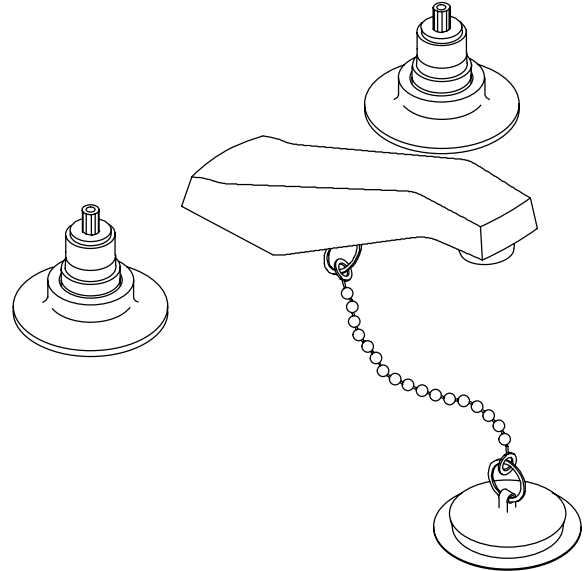

**CODES/STANDARDS APPLICABLE**

Specified model meets or exceeds the following:







- ASME/ANSI A112.18.1M
- California Energy Commission
- Energy Policy Act of 1992
- IAPMO/UPC
- NSF 14

**COLORS/FINISHES**

- CP Polished Chrome

**SPECIFIED MODEL:** For complete faucet, both base faucet and handle choice must be specified.

Model	Description	
K-7444-K	With Standard Aerator	<input type="checkbox"/> CP
K-7444-KE	With Vandal-Resistant Aerator	<input type="checkbox"/> CP

Handle Options (Includes Two Handles)		 ADA	 ADA	 ADA	 ADA	
K-16012-2 Triton Standard Handles	<input type="checkbox"/> CP					
K-16012-3 Triton Cross Handles		<input type="checkbox"/> CP				
K-16012-4 Triton Lever Handles			<input type="checkbox"/> CP			
K-16012-5 Triton Wristblade Lever Handles				<input type="checkbox"/> CP		
K-16022-5 Finesse Wrist Control Lever Handles					<input type="checkbox"/> CP	
K-16032-7 Flair Sculptured Acrylic Handles						<input type="checkbox"/> CP

**PRODUCT SPECIFICATION:**

Two-handle widespread lavatory base faucet shall be of brass construction. Faucet shall feature brass valve bodies. Faucet shall feature quarter-turn washerless ceramic disc valves, assuring positive handle stop positioning. Product shall include flexible connections, 5" spout, and chain and stopper drain. Optional feature shall be standard or vandal-resistant Water-Guard aerator. Base faucet shall be Kohler Model K-7444-\_\_\_\_-CP and handles shall be Kohler Model K-\_\_\_\_\_-\_\_\_\_-CP.

# TRITON™ /FINESSE™ /FLAIR™ ACRYLIC

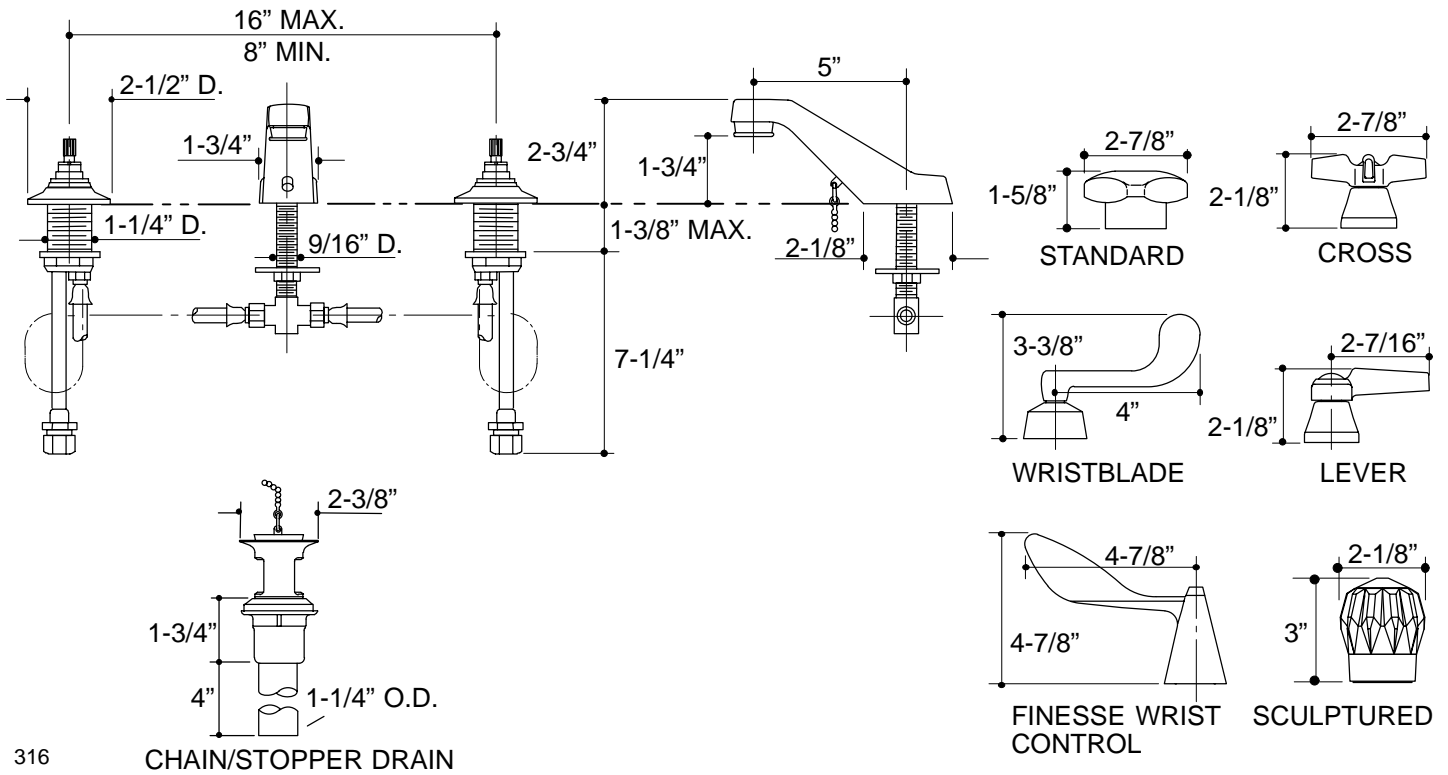

316

## PRODUCT DIAGRAM