



LIGHTING SPECIFICATIONS

Wiedenbach-Brown Co., Inc.
 22901 La Palma Ave.
 Yorba Linda, CA 92887
 714.692.2200 Telephone
 714.692.2550 Fax

11.23.09

PROJECT: PAUL MITCHELL SCHOOLS
 LOCATION: MURFREESBORO, TN

PREPARED FOR: PAUL MITCHELL, THE SCHOOL
 PREPARED BY: BONNIE JENKINSON

**	FIXT - TYPE	MANF	CATALOG #	DESCRIPTION	
	A	COOPER	L530039ECGMBLISS	TRACKHEAD	
	A	COOPER	LZR108MB	TRACK	
	A	COOPER	LZR212MB	MINI COONNECTOR	
	A	COOPER	LZR203MB	L CONNECTOR	
	A	COOPER	LZR201MB	LIVE END	
	A	COOPER	LZRC201MB	LIMITING END FEED BLACK	
	A	COOPER	CB600MB	120W CIRCUIT BREAKER	CONFIRM AMPERAGE(S)
	A1	COOPER	L1808PAL / L1980MB	TRACK HEAD	
	A1	COOPER	L653MB	TRACK	
	A1	COOPER	L901MB	LIVE END	
	B	COOPER	C7242E	DOWNLITE	
	B	COOPER	7350LI	REFLECTOR	
	B	COOPER	HB26	HANGER BARS	
	B1	COOPER	C7142E	DOWNLITE	
	B1	COOPER	7150LI	REFLECTOR	
	B1	COOPER	HB26	HANGER BARS	
	C	COOPER	H36LVTAT	HOUSING	Confirm voltage is 120V
	C	COOPER	3004WHC	TRIM	
	D1	CORELITE	R2-W-L-2T5-1-C-24-UNV	2X4 SHALLOW RECESSED	
	D1F	CORELITE	R2-W-L-2T5-1-C-24-UNV-FLANGED	2X4 SHALLOW RECESSED FLANGED	
	D1F	CORELITE	DF-24-W	FLANGE KIT	
	D6F	CORELITE	R2-WL-3T5-1-C-24-UNV	2X4 SHALLOW RECESSED 3 LAMP	
	D6F	CORELITE	DF-24-W	FLANGE KIT	
	E	METALUX	W-232A-UNV-EB81-U	SURFACE MOUNT 2L WRAP	
	G16	FOCAL POINT	FEVS-CT-2T8-1C-UNV-S-C48-TS-16	SURFACE MOUNT 16' LINEAR	
	H	COOPER	ICVC1G	GLOBE FIXTURE	
	J1	COOPER	MD-HB-PD16-M-100E-SHK-PC3	HIGH BAY	Confirm voltage is 120V
	K1	PRISMA	073726 / 2781	PENDANT	ADVISE FINISH OF DIFFUSER
	EM	COOPER	CC5WH215	EM 2LT 6V 9W UNV	
	X	BEST	EZXTEU2RWEM	LED 1-2 RED/WHT UNVEM BAUP DAMP LOC	
	X2	BEST	EZXTEU2RWEMRC	LED 1-2 RED/WHT UNVEM BAUP W/REMOTE CAPABILITY	
	X2-R	BEST	RH1WP6V7	1LT 6V OUTDOOR REMOTE HEAD WEATHERPROF	
	OS	HUBBELL	OMINI-DT2000	OCCUPANCY SENSOR	
	POWER PACK	HUBBELL	UVPP	POWER PACK	
	WALL OS	HUBBELL	LHIRS1W	WALL OCCUPANCY SENSOR	
	DIMMER	LUTRON	NTLV-1000-WH	LO VOLTAGE DIMMER (C)	
	DIMMER	LUTRON	NT-1500-WH	INCANDESCANT DIMMER (A1)	
LAMP	MANF	CATALOG #			
A, A1	GE	18631		100PAR/HIR/FL25-120V	
B	GE	97630		F32TBX/830/A/ECO	
B1	GE	97615		F26TBX/830/A/ECO	
C	GE	16716		Q37MR16/HIR/CG25-12V QTZLM	
D1, D1F, D6F	GE	46759		F54WT5/830/ECO	
E, G16	GE	25611		F32T8/SPX30/ECO	
H, K1	GE	48688		60A/RVLJ48PK 60W 120 INC.	
J1	GE	22137		CNH100/C/U/830/MED	

DESCRIPTION

A low wattage metal halide track fixture utilizing 39 watt T4.5 ceramic metal halide capsules providing compact size and fixed optic. Ideal for accent lighting applications where a precise, tightly controlled beam of light is required. This fixture provides high efficiency, good color rendering and long life.

Catalog #	L530039ECGMBLSS	Type	A
Project	PAUL MITCHELL SCHOOL	Date	
Comments			
Prepared by			

SPECIFICATION FEATURES

A...Electrical Quick Lock Adapter - Power-Trac
Polycarbonate housing. Attaches electrically and mechanically anywhere along track.

A1...Electrical Quick Lock Adapter - Flexible Track
Die cast housing. Attaches electrically and mechanically anywhere along track.

A2...Electrical Quick Lock Adapter - Architectural Track
Polycarbonate housing with integral fuse and On-Off switch. Attaches electrically and mechanically anywhere along track.

B...Ballast Housing
Injection molded housing incorporates the lamp control circuit.

C...Switch
On-off switch allows power to be turned off during lamp replacement on individual lampholders

D...Lamp Housing
Injection molded lamp housing has an integral precision reflector allowing a tight beam of light (approximately 6°). Lamp housing adjusts ±90° providing full aiming adjustment and eliminates the "dead zone" found

with other fixture designs.

F...Lens
Removable front bezel with glass lens provides lamp containment. The front bezel accepts up to two media - L200 color filters and beam modifying lenses, as well as glare guards for improved cutoff and beam enhancement.

Labels
UL/cUL listed for use with Halo Track systems.
EMI/RFI complies with FCC 18C, non-consumer limits.



**L5300
LA5300
LF5300
39W
Super Spot**

**MiniLUME
Ceramic
Metal Halide**

Power-Trac

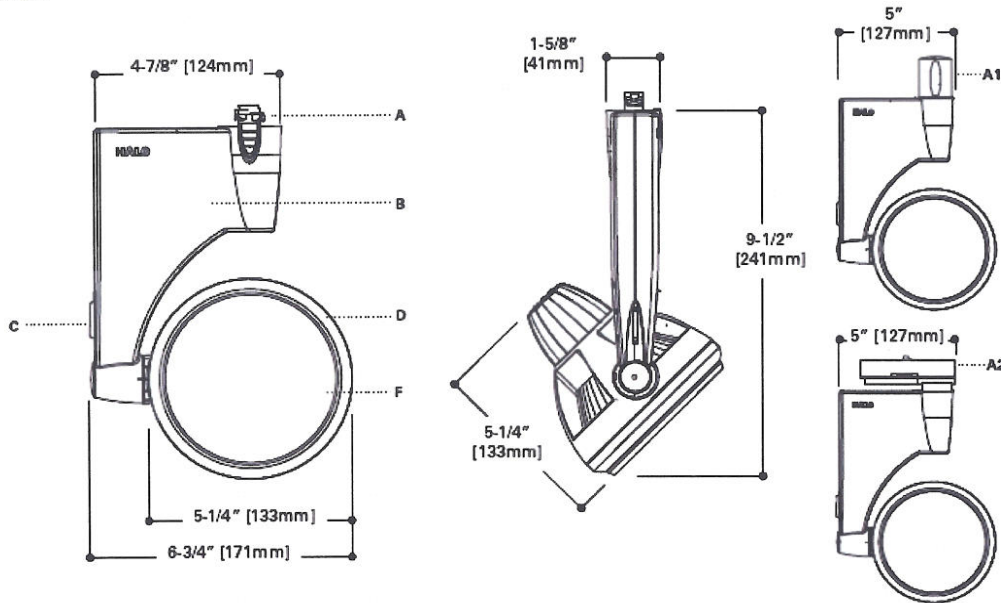

miniLUME™

Energy Data

39W Electronic Ballast
Input Power: 45W
Power Factor: >0.95
Input Current: 0.37A max.
Harmonic Distortion: <10%

NOTES:
Accessories should be ordered separately.

ORDERING INFORMATION: SAMPLE NUMBER: L530039ESCPLSS

Lampholder	Ballast	Reflector Finish	Finish	Lamp	Type	Accessories
L5300	39E	GC	MB	L	SS	
L5300=For use with Halo Power Track and Lazer Track LA5300=For use with Halo Architectural Track LF5300=For use with Halo Flexible Track	39E = 39 Watt Electronic Ballast	SC = Specular Clear Reflector Finish CG = Commercial Gold Reflector Finish	W=White MB=Black S=Silver MB/GY=Black with Grey Knob and Trim Ring P/GY=White with Grey Knob and Trim Ring	L=Lamp included but not installed	SS=Super Spot	Z79=39W T4.5 CMH Lamp GG15MB=Glare Guard Black 15° Cutoff GG30MB=Glare Guard Black 30° Cutoff GG45MB=Glare Guard Black 45° Cutoff L200 Series=Color Filters or Beam Modifying Lenses

ACCESSORIES

Glare Guards

- GG15MB=Glare Guard Black 15° Cutoff
MB=Black
- GG30MB=Glare Guard Black 30° Cutoff
MB=Black
- GG45MB=Glare Guard Black 45° Cutoff
MB=Black

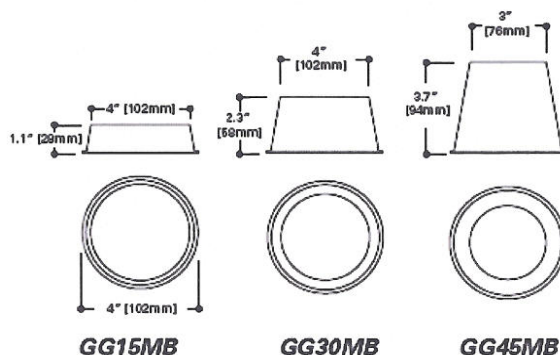

Glare Guards

PHOTOMETRICS

**L5300 Super Spot
Report No. H20125**

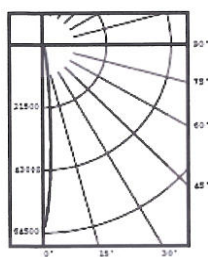

Candelas at Nadir	
Deg	Candela
0	78268
5	22676
15	1097
25	306
35	221
45	121
55	28
65	23
75	22
85	12
90	6



**0° Aiming Angle
Horizontal Footcandles**



**30° Aiming Angle
Horizontal Footcandles**



**30° Aiming Angle
Vertical Footcandles**



**60° Aiming Angle
Vertical Footcandles**

CMH39/TC/U/830G8.5
Lumens: 3400 Lumens

Report No.: H20125

D	FC	L	W
10.0	783	1.3	1.3
12.5	501	1.6	1.6
15.0	348	2.0	2.0
20.0	196	2.6	2.6
25.0	125	3.3	3.3
30.0	87	3.9	3.9
40.0	49	5.2	5.2

D	FC	L	W	CB
10.0	508	1.6	1.4	5.8
12.5	325	2.0	1.8	7.2
15.0	226	2.5	2.1	8.7
20.0	127	3.3	2.8	11.5
25.0	81	4.1	3.5	14.4
30.0	56	4.9	4.2	17.3
40.0	32	6.6	5.7	23.1

D	FC	L	W	CB
2.0	2446	1.0	0.5	3.5
3.0	1087	1.4	0.8	5.2
4.0	611	1.9	1.0	6.9
5.0	391	2.4	1.3	8.7
6.0	272	2.9	1.5	10.4
8.0	153	3.8	2.0	13.9
10.0	98	4.8	2.6	17.3
12.0	68	5.7	3.1	20.8

D	FC	L	W	CB
2.0	12709	0.3	0.3	1.2
3.0	5649	0.5	0.4	1.7
4.0	3177	0.7	0.6	2.3
5.0	2033	0.8	0.7	2.9
6.0	1412	1.0	0.8	3.5
8.0	794	1.3	1.1	4.6
10.0	508	1.6	1.4	5.8
12.0	353	2.0	1.7	6.9

Notes and Definitions:

- Beam spread is to 50% center beam candlepower (CBCP.)
- D=Distance in feet to floor or wall.
- FC=Footcandles on floor or wall at center beam aiming location.
- L=Effective Visual Beam length in feet (50% of maximum footcandle level.)
- W=Effective Visual Beam width in feet (50% of maximum footcandle level.)
- CB=Distance in feet across or down to center beam location.

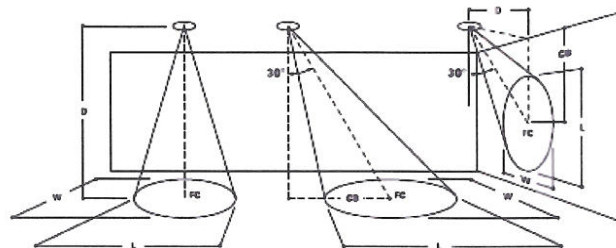

Note: Specifications and Dimensions subject to change without notice.
Visit our web site at www.cooperlighting.com

DESCRIPTION

LAZER

The Lazer Two-Conductor track is available in two finishes and 4 lengths. The overall height is only 9/16" and the track has a decorative reveal at the ceiling line. It accepts both Lazer Track lampholders and Halo Power-Trac lampholders. Lazer Track is UL listed and CSA certified.

Catalog #	LZR108MB	Type	A
Project	PAUL MITCHELL SCHOOL	Date	
Comments			
Prepared by			

SPECIFICATION FEATURES

A. Structural: Extruded aluminum .050" [1.3mm] nominal wall thickness

B. Line Conductor: Solid copper bus bars -cross section equivalent to #12 AWG wire.

C. Insulating Liner: Extruded polyvinyl insulator.

D. Neutral Conductor: cross section equivalent of #12 AWG wire.

E. Polarity Indicator: Visual polarity groove indicates proper electrical installation of lampholder adapter.

Construction

The structural channel is extruded aluminum with .050" nominal wall thickness. Conductors are solid copper bus bars encased in rigid extruded PVC insulators. Polarized connectors and end

caps are molded polycarbonate. Electrical capacity is 20 AMPS.

Size

Miniature Trac is only 9/16" (14mm) deep by 1 3/8" (35mm) wide.

Finishes

Miniature Trac is available in two finishes: White (P) and Matte Black, (MB).

Connectors

Connectors simply push into the ends of the Trac, eliminating splicing. Straight, right angle, X's, T's and flexible connectors allow track to be assembled in almost any pattern.

Grounding

Grounding is accomplished through a grounding channel in the track. The track maintains continuity to the building's grounding system through the ground contact fingers in each of the connectors.

Polarity

A visual polarity line on Lazer Track indicates proper electrical installation. Simply line up polarity on Lazer Track and lampholder adapter.

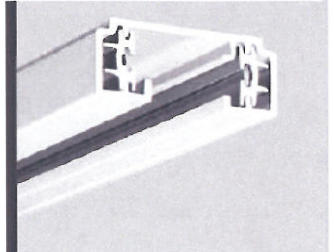
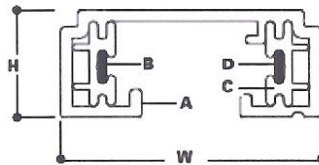

**LZR102, LZR104
LZR106, LZR108**

**MINIATURE
SINGLE CIRCUIT
TRAC SYSTEM**

Lazer-Trac

ORDERING INFORMATION

SAMPLE NUMBER: LZR108P

Track		Finishes		Accessories	
LZR108		MB			
LZR102	LZR106	P=Satin White		(See Below)	
LZR104	LZR108	MB=Matte Black			
LZR102	LZR104	LZR106	LZR108		
L = 2' nominal Actual length: 20-1/8" [511mm] W=1-3/8" [35mm] H = 9/16" [14mm]	L = 4' nominal Actual length: 44-1/8" [1121mm] W=1-3/8" [35mm] H = 9/16" [14mm]	L = 6' nominal Actual length: 68-1/8" [1730mm] W=1-3/8" [35mm] H = 9/16" [14mm]	L = 8' nominal Actual length: 92-1/8" [2492mm] W=1-3/8" [35mm] H = 9/16" [14mm]		
Finish Codes	Finish Codes	Finish Codes	Finish Codes		
P, MB	P, MB	P, MB	P, MB		

**VERIFY
AMPERAGE**

Connectors

LZR200	Live End Feed with Junction-Box Cover
LZR201	Live End Feed
LZR202	Floating Canopy and Connector
LZR203	Adjustable L and Straight Connector
LZR204	Conduit Adapter Feed
LZR205	Conduit Continuation Feed
LZR206	T-Bar Canopy
LZR208	Cord and Plug Feed
LZR211	Flexible Connector Feed
LZR212	Mini Joinder
LZR213R	"T" Connector - Right
LZR213L	"T" Connector - Left
LZR214	"X" Connector

Accessories

LZR207	T-Bar Mounting Clip
LZR209	Monopoint Feed
LZR210	Monopoint Feed - Low Voltage
Current Limiter - End Feed	
LZRC201CB120-120W (1A @120V)	
LZRC201CB300-300W (2.5A @120V)	
LZRC201CB600-600W (5A @120V)	
LZRC201CB960-960W (8A @120V)	
LZRC201CB1200-1200W (10A @120V)	
Current Limiter - Center Feed	
LZRC203CB120-120W (1A @120V)	
LZRC203CB300-300W (2.5A @120V)	
LZRC203CB600-600W (5A @120V)	
LZRC203CB960-960W (8A @120V)	
LZRC203CB1200-1200W (10A @120V)	

Finishes

P	White
MB	Black

LZRC201, LZRC203
Current Limiter - End and Center Feeds

End-feed and Center-feed capable:
 Five breaker sizes are available. Consult factory if other sizes are required. Can be utilized on hard or grid ceilings. Can be used with pendant suspended track. Breaker can be used as an on-off switch. Breaker features a "tripped" condition indicator. Approved by the California Energy Commission - meets Title 24 requirements. cULus Listed

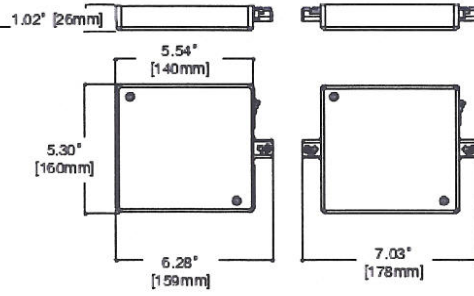

Feed Type	Circuit Breaker	Finish
LZRC201 = Lazer 1-Circuit End Feed	CB120 = 120W (1A @ 120V) CB300 = 300W	P = White MB = Black
LZRC203 = Lazer 1-Circuit Center Feed	CB250 = 250W (2.5A @ 120V) CB600 = 600W (5A @ 120V) CB800 = 800W (8A @ 120V) CB1200 = 1200W (10A @ 120V)	

**VERIFY
 AMPERAGE**

Sample catalog number: LZRC201CB120P
 (Field assembly of feed and circuit breaker required)
 Consult factory for Single Circuit Center-feed requiring two circuit breakers

- LZR212MB
- LZR203MB
- LZR201MB
- LZRC201MB
- CB600MB

**LZRC201
 LZRC203**

Connectors specifically for Lazer-by-Halo Track sections. Use for forming almost any configuration of track layouts.

LZR208 Cord and Plug Feed

10' three-wire cord with grounded plug. Maximum capacity 5 AMPS.

Finish Codes: P, MB

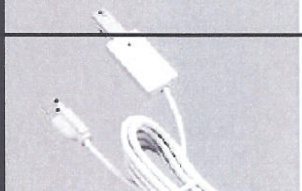
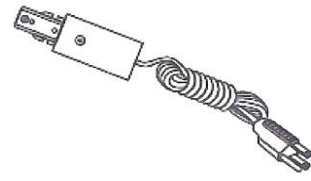

LZR208

ORDERING INFORMATION

Connector	Finish
LZR208	

LZR211 Flexible Connector Feed

To connect two track sections at any angle up to 90° or for connecting wall and ceiling mounted track. Can be used as electrical feed point.

Finish Codes: P, MB

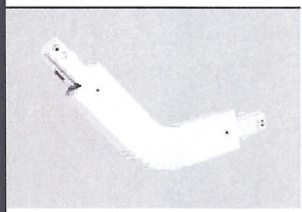
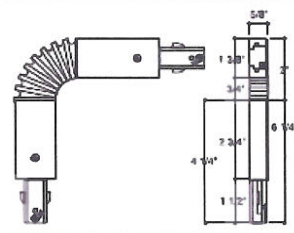

LZR211

ORDERING INFORMATION

Connector	Finish
LZR211	

LZR212 Mini Connector

For joining two track sections end-to-end. LZR212 is not an electrical feed.

Finish Codes: P, MB

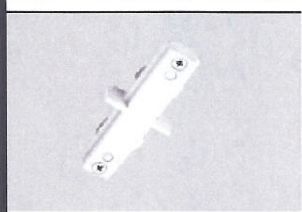
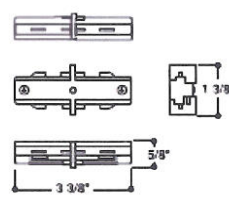

LZR212

ORDERING INFORMATION

Connector	Finish
LZR212	

LZR200 Live End Feed with Junction Box Cover

For starting a track run at beginning of track and when connector is mounted to a junction box.

Finish Codes: P, MB

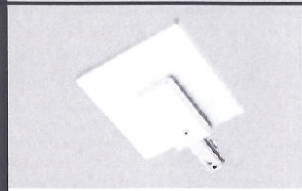
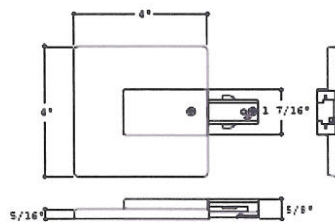

LZR200

ORDERING INFORMATION

Connector	Finish
LZR200	



LZR201 Live End Feed

For starting a track run at beginning of track.

Finish Codes: P, MB

ORDERING INFORMATION

Connector

Finish

LZR201

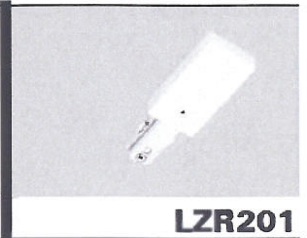
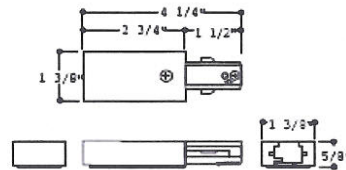

LZR201

LZR202 Floating Canopy and Connector Feed

Track can be connected to existing outlet box located anywhere along the track. Comes with canopy cover, connector, dead end and mounting hardware.

Finish Codes: P, MB

ORDERING INFORMATION

Connector

Finish

LZR202

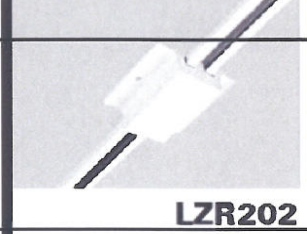
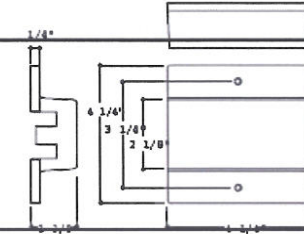

LZR202

LZR203 Adjustable "L" and Straight Connector Feed

To connect two track sections at right angles or straight end-to-end. Includes straight and right angle covers. Can be used as an electrical feed.

Finish Codes: P, MB

ORDERING INFORMATION

Connector

Finish

LZR203

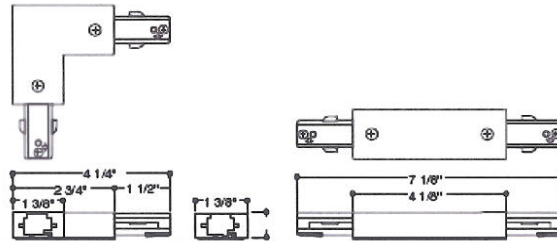

LZR203

LZR213R "T" Connector (Right)

LZR213L "T" Connector (Left)

Use for joining three track sections. Select Right(R) or Left (L) Handed versions to maintain proper polarity. May be used as an electrical feed point.

Finish Codes: P, MB

ORDERING INFORMATION

Connector

Finish

LZR213R

LZR213L

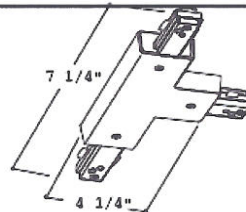

LZR213

LZR214 "X" Connector

Use for joining four track sections. May be used as an electrical feed point.

Finish Codes: P, MB

ORDERING INFORMATION

Connector

Finish

LZR214

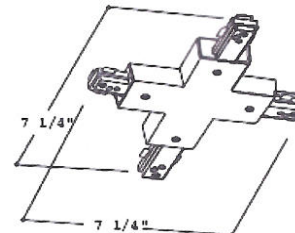

LZR214

LZR204 Conduit Adapter Feed

Designed to accept 1/2" trade size conduit fitting (not supplied). Use when feeding to track through surface conduit system.

Finish Codes: P, MB

ORDERING INFORMATION

Connector

Finish

LZR204

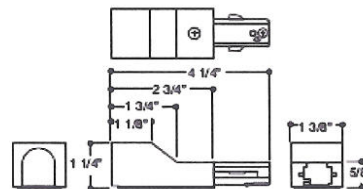

LZR204

LZR205 Conduit Continuation Feed

Includes one left feed and one right feed to continue a run around obstructions. Requires 1/2" trade size fitting.

Finish Codes: P, MB

ORDERING INFORMATION

Connector	Finish
LZR205	<input type="text"/>

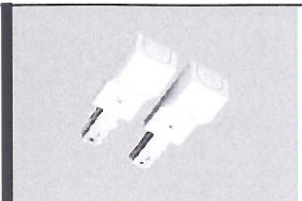
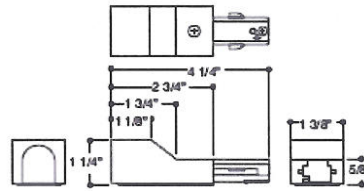

LZR205

LZR206 T-Bar Canopy Feed

For installing track on T-Bar ceilings. LZR201 or LZR203 also required.

Finish Codes: P

ORDERING INFORMATION

Connector	Finish
LZR206	<input type="text"/>

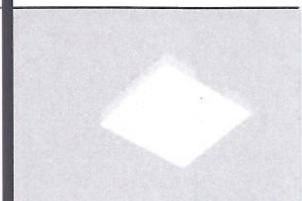
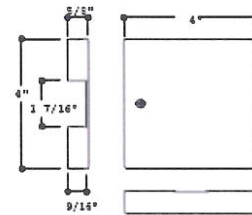

LZR206

LZR207 T-Bar Mounting Clip

For installing track to a suspended ceiling. Kit contains 3 clips for mounting 2', 4', 6', or 8' track. Order one kit for each track section. Compatible with Halo and Lazer track.

ORDERING INFORMATION

Connector	Finish
LZR207	<input type="text"/>

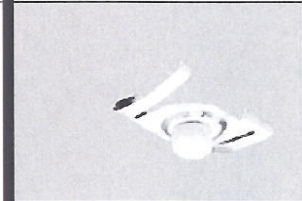
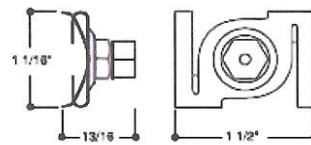

LZR207

Lazer monopoints allow the installation of a single lampholder without using a complete track installation

LZR209 Monopoint Feed

For installing one Halo or Lazer track lampholder. Mounts directly to junction box. 500 watt maximum. Not compatible with Halo or Lazer low voltage lampholders with integral solid state power supplies.

Finish Codes: P, MB

ORDERING INFORMATION

Connector	Finish
LZR209	<input type="text"/>

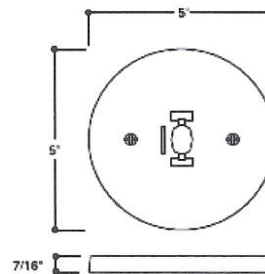

LZR209

LZR210 Monopoint Feed - Low Voltage

For installing one Halo or Lazer low voltage lampholder. Mounts directly to junction box. 500 watt maximum.

Finish Codes: P, MB

ORDERING INFORMATION

Connector	Finish
LZR210	<input type="text"/>

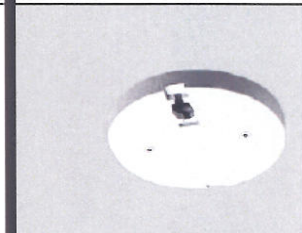
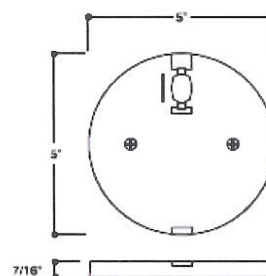

LZR210

DESCRIPTION

A series of Power track lampholders designed with the style and flair of theatrical spotlights. They are suitable for both commercial and residential applications. Lamp usage ranges from PAR20 to PAR38. For use with Halo and Lazer-by-Halo track systems.

Catalog #	L1808PAL / L1980MB	Type	A1
Project	Paul Mitchell, The School		
Comments		Prepared by	Date

SPECIFICATION FEATURES

A -- Electrical Quick Lock Adapter

Polycarbonate casing. Attaches electrically and mechanically anywhere along the track. Visual polarity line assures proper grounding. Two position conductor allows use in single circuit and either circuit of two circuit track. **B -- Yoke**

Extruded aluminum yoke allows lampholder to rotate horizontally 338° for maximum aiming adjustability and adjust 0° to 90° vertically.

C -- Body

Spun aluminum body with removable rear socket holder to facilitate relamping. Polished Aluminum (PAL) or Matte Black (MB) finish.

D -- Adjustment Knob

Black adjustment knob maintains aiming position. L1806 and L1807 fitted with two knobs, L1808 fitted with one.

E -- Accessory Clips

Accessory clips provided with lampholders. Spring loaded clip

provides easy installation of gel holders and barn door shutters.

F -- Gel Holders

Gel Holders provided with each lampholder available in either Polished Aluminum or Matte Black to match lampholder body.

Listings

UL listed and CSA certified for use with Halo and Lazer-by-Halo track and track systems.

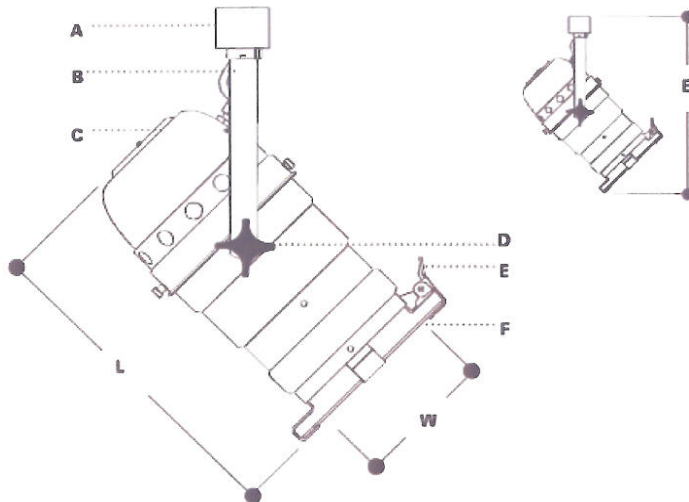

L1806



L1807



L1808

ORDERING INFORMATION

SAMPLE NUMBER: L1806PAL

Lampholders	Finishes
L1808	PAL
L1806 L1807 L1808	PAL=Polished Aluminum MB=Matte Black

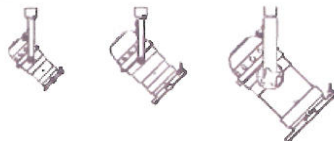

L1806

For use with: 50W PAR20

L = 6 1/2" [165mm]
W = 2 1/2" [64mm]
E = 9 1/2" [241mm]

Accessories

L1978MB, PAL= Accessory Barn Door Shutter

L1807

For use with: 75W PAR30

L = 8 3/4" [222mm]
W = 3 5/16" [84mm]
E = 12" [305mm]

Accessories

L1979MB, PAL= Accessory Barn Door Shutter

L1808

For use with: 250W PAR38

L = 11 3/4" [298mm]
W = 5" [127mm]
E = 15 1/4" [384mm]

Accessories

L1980MB, PAL= Accessory Barn Door Shutter

STUDIO CLASSIC
LAMP HOLDERS

Power-Trac

ACCESSORIES

Barn Door Shutters

L1978=Barn Door Shutters for L1806

Finish Code:

PAL=Polished Aluminum

MB=Matte Black

L1979=Barn Door Shutters for L1807

Finish Code:

PAL=Polished Aluminum

MB=Matte Black

L1980=Barn Door Shutters for L1808

Finish Code:

PAL=Polished Aluminum

MB=Matte Black

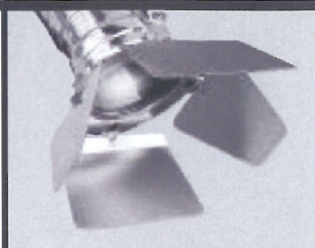

BARN DOOR SHUTTERS

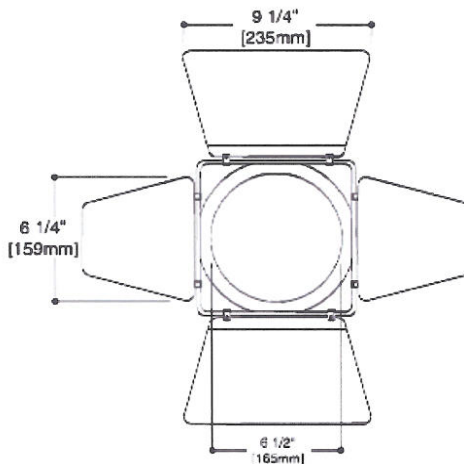
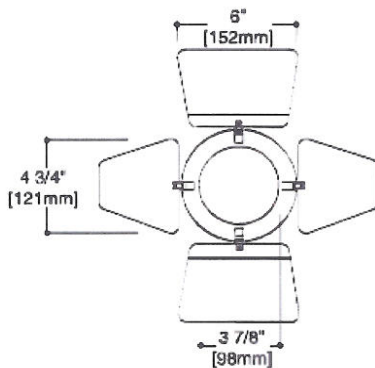
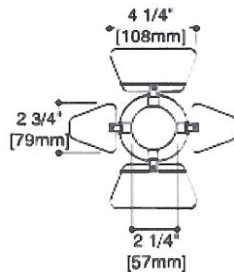

Note: Specifications and Dimensions subject to change without notice.

Visit our website at www.cooperlighting.com

Customer First Center 1121 Highway 74 South Peachtree City, GA 30269 770.486.4800 FAX 770 468.4801 ADV990044
Cooper Lighting 5925 McLaughlin Rd. Mississauga, Ontario, Canada L5R 1B8 905.507.4000 FAX 905.568.7049

DESCRIPTION

Miniature size, decorator finishes, push-in connectors, economy, all combine to make single-circuit Miniature Trac perfect for residential or commercial use. Polarized connectors and end caps are molded polycarbonate. Halo Miniature Track accepts both Halo and Lazer-by-Halo lampholders.

Catalog #	L653MB/L901MB	Type	A1
Project	Paul Mitchell, The School	Date	
Comments			
Prepared by			

SPECIFICATION FEATURES

A. Structural

Extruded aluminum .060" [1.5mm] nominal wall thickness

B. Line Conductor:

Solid copper buss bars [cross section equivalent to #12 AWG wire].

C. Insulating Liner

Extruded polyvinyl insulator.

D. Ground Conductor

Exclusive independent grounding buss conductor. Maintains an independent positive ground #12 AWG path between lampholder, Trac channel and building's ground system.

E. Neutral Conductor

Cross section equivalent of #12 AWG wire.

F. Polarity Indicator (Neutral)

Visual polarity groove indicates proper electrical installation of lampholder adapter.

Listings

UL listed and CSA certified for use with Halo and Lazer-by-Halo lampholders.

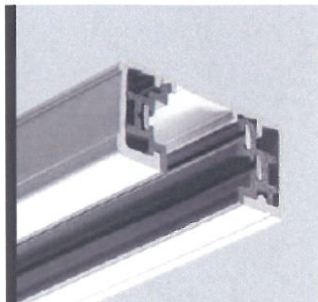

**L650, L651
L652, L653**

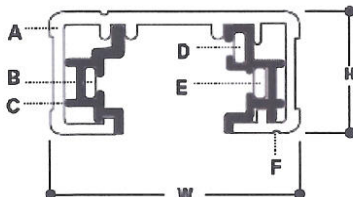

**MINIATURE
SINGLE CIRCUIT
120V TRAC SYSTEM**

Power-Trac

ORDERING INFORMATION

SAMPLE NUMBER: L651MB

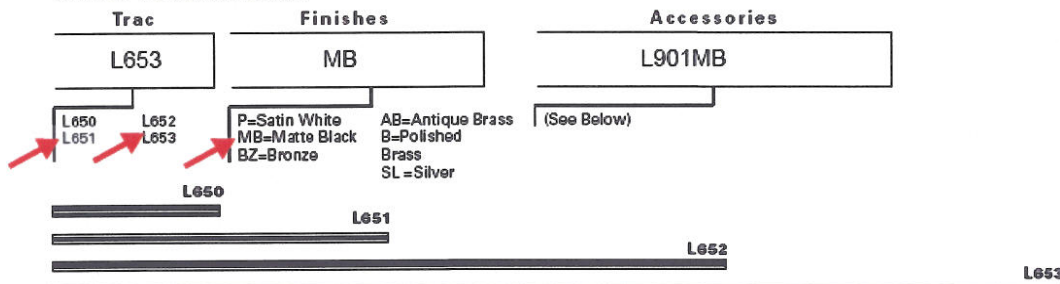

L650	L651	L652	L653	Connectors
L = 2' Actual length 20 1/8" [611mm] W=1 3/8" [35mm] H =11/16" [17.5mm]	L = 4' Actual length 44 1/8" [1121mm] W=1 3/8" [35mm] H =11/16" [17.5mm]	L = 8' Actual length 92 1/8" [2339mm] W=1 3/8" [35mm] H =11/16" [17.5mm]	L = 12' Actual length 140 1/8" [3559mm] W=1 3/8" [35mm] H =11/16" [17.5mm]	L900 Outlet Box Cover L901 Live End connector L902 Flexible Connector L903 Straight Connector L904 L Connector L905 T Connector L906 X Connector L907 Outlet Box for use with T-Bar ceiling L908 Mini Joiner L909 Floating Canopy and Connector L950 Cord and Plug Connector L979 Conduit Continuation Kit L980 Live End Conduit Adapter DE600 Dead End
Color codes P = White MB = Black B = Polished Brass SL = Silver	Color codes P = White MB = Black BZ = Bronze AB = Antique Brass B = Polished Brass SL = Silver	Color codes P = White MB = Black BZ = Bronze AB = Antique Brass B = Polished Brass SL = Silver	Color codes P = White MB = Black SL = Silver	L983 T-Bar Attachment Clip L992 Pendant Kit assembly L48 48" Steel Stem L994 Pendant Adapter

ADV042177

Supersedes ADV021436 & ADV990406
9/04

TAB: Track Systems
Sheet 1

Note: Specifications and Dimensions subject to change without notice.

Visit our web site at www.cooperlighting.com

DESCRIPTION

L900 Outlet Box Cover

Can be used at any electrical feed connection point (Live, Straight, L, T or X). Drill guides on back for virtually all standard outlet boxes. Size: 5" sq. Screws included.

Color codes: P (White), MB (Black)

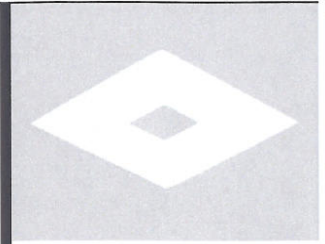
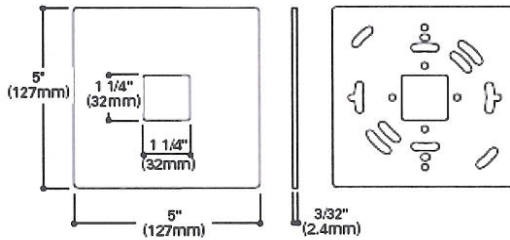

L900

ORDERING INFORMATION

Connector	Finish
L900	

L901 Live End Connector

To start a run.

Color codes: P (White), MB (Black)

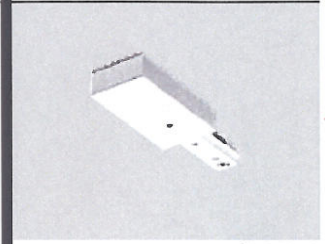
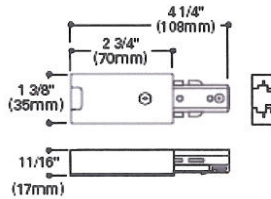

L901

ORDERING INFORMATION

Connector	Finish
L901	MB

L902 Flexible Connector

To connect two track sections at any angle up to 90° in either plane or wall to ceiling or pitched ceiling applications.

Color codes: P (White), MB (Black)

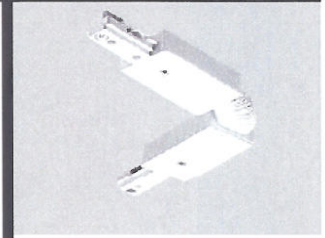
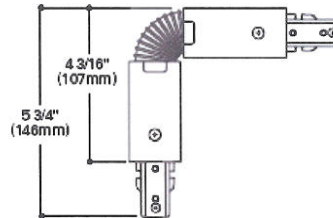

L902

ORDERING INFORMATION

Connector	Finish
L902	

L903 Straight Connector

To connect two track sections end-to-end. L903 differs from mini connector L908 in that it provides a center feed option and is longer. May be used as feed point.

Color codes: P (White), MB (Black)

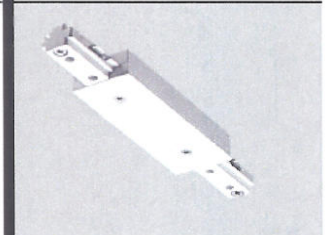
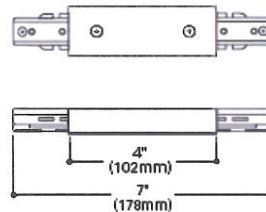

L903

ORDERING INFORMATION

Connector	Finish
L903	

L904 L Connector

To connect two track sections at a right angle. Field adjustable for either right hand or left hand application. May be used as feed point.

Color codes: P (White), MB (Black)

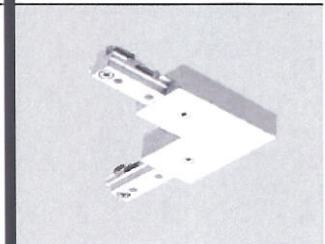
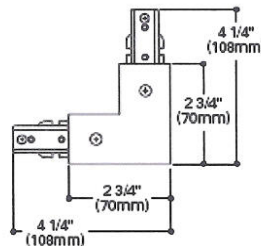

L904

ORDERING INFORMATION

Connector	Finish
L904	

Note: Specifications and Dimensions subject to change without notice.

Visit our web site at www.cooperlighting.com

Customer First Center 1121 Highway 74 South Peachtree City, GA 30269 770.486.4800 FAX 770.486.4801
Cooper Lighting 5925 McLaughlin Rd. Mississauga, Ontario, Canada L5R 1B8 905.507.4000 FAX 905.568.7049

DESCRIPTION

Low brightness 7-3/8" aperture downlight for use with (2) 26W, 32W, or 42W Triple Twin Tube 4-pin compact fluorescent lamps. The precisely formed non-imaging optical reflector ensures 55° cutoff to lamp and lamp image and the one piece design eliminates light leaks at the ceiling. Standard features include low iridescent finish on all reflector colors to eliminate "rainbowing" and one electronic ballast to operate (2) 26/32/42W triple lamps. Venting ensures maximum lamp life and lumen output. Optics offer unparalleled performance in glare free lighting with a smooth beam devoid of hot spots. Open downlight, lens, and open wall wash trims are interchangeable within the same housing.

SPECIFICATION FEATURES

A ... Reflector

One piece spun parabolic contour, available in a variety of Alzak® finishes. Positive reflector mounting, without tools, pulls trim tight to ceiling. Also available with white or black baffle.

B ... Trim Ring Options

Self flanged or molded white trim ring. Rimless or metal trim ring accessories available.

C ... Socket Connector

One piece die cast aluminum connection allows venting for maximum thermal performance.

D ... Housing Mounting Frame

One piece precision die cast aluminum 1-1/2" deep collar accommodates varying dimensions of ceiling materials.

E ... Universal Mounting Bracket

Accepts 1/2" EMT, C Channel, T bar fasteners, and bar hangers. Adjusts 5" vertically from above or below ceiling.

F ... Conduit Fittings

Die cast screw tight connectors.

G ... Junction Box

Listed for eight #12AWG (four in, four out) 90°C conductors feed through branch wiring.

One 1/2" and two 3/4" pry outs. Positioned to allow straight conduit runs. Access to junction box by removing reflector.

H ... Socket Rotary Lock
4 pin GX24q3/4 base with fatigue free stainless steel lamp spring ensures positive lamp retention.

I ... Electronic Ballast

Electronic ballast provides full light output and rated lamp life. Provides flicker free and noise free operation and starting.

Labels

cULus listed, standard damp label.

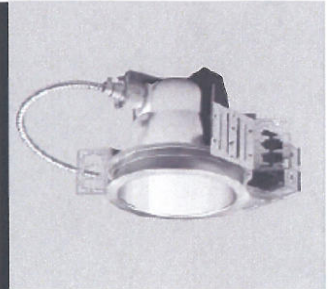

C7242
7351/7350

(2) 26W, 32W, 42W TTT
Compact Fluorescent

7-3/8" OPEN DOWNLIGHT

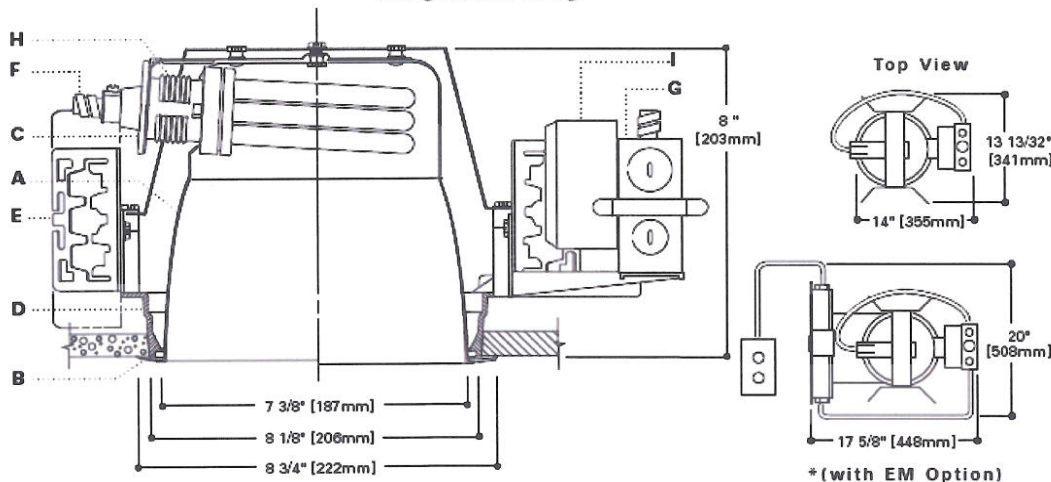

NOTES:
Accessories should be ordered separately. For additional options please consult your Cooper Lighting Representative. Alzak is a registered trademark of Aluminum Company of America. Hi-Lume is a registered trademark of Lutron Co. Inc.

ORDERING INFORMATION

Sample Number: Complete unit consists of housing, ballast and trim.

C7	2	42	E	7350	LI	HB26		
Housing C7: 7" Horizontal Lamp	Number of Lamps 2: 2 Lamps	Wattage 42: 26W, 32W, or 42W TTT Lamp	Ballast E: 120/277V 50/60 Hz Electronic 3E: 347V 50/60 Hz Electronic 1D26: 26W 120V Dimming, Lutron Compact SE 2D26: 26W 277V Dimming, Lutron Compact SE 1D32: 32W 120V Dimming, Lutron Compact SE 2D32: 32W 277V Dimming, Lutron Compact SE 1D42: 42W 120V Dimming, Lutron Compact SE 2D42: 42W 277V Dimming, Lutron Compact SE EDR26: DeRated Wattage Label, 26W EDR32: DeRated Wattage Label, 32W	Options CP: Chicago Plenum EM: Emergency Module with remote test switch IEM: Emergency Module with integral test switch 2C: (2) ballasts for Hi-Low Switching 2CMS: 2 Circuit Master Satellite (2 housings, order 2 trims)	Trims 7351: Self Flanged 7350: Molded Trim Ring 7351E: Self Flanged, use with IEM 7350E: Molded Trim Ring, use with IEM	Finish LI: Low Iridescent Clear H: Haze WMH: Warm Haze G: Gold WH: Wheat WF: Gloss White GP: Graphite GPH: Graphite Haze K: Cognac KH: Cognac Haze BB: Black Baffle (7350 only) WB: White Baffle (7350 only)	Option WF: White Painted Flanged (Self Flanged only)	Accessories HB26: C Channel Bar Hangers, 26" Long, Pair HB50: C Channel Bar Hangers, 50" Long, Pair TRM7: Metal Trim Ring, Specify Finish TRR7: Rimless Trim Ring, White FK5: 5 Amp Field Installable Fuse Kit 300V Max DT7: Deco Trims RMB-22: Wood Joist Bar Hanger, 22" Long, Pair HSA7: Slope Adapter for 7" Aperture Housings, Specify Slope

Specifications and Dimensions subject to change without notice.

Consult your representative for additional options and finishes.

Candlepower Distribution Curve

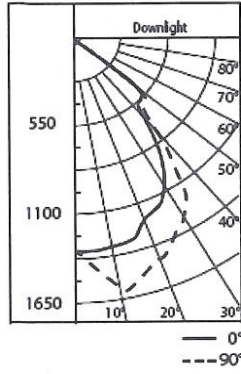

Candelas

Degree	CD
0	1279
5	1293
15	1277
25	1153
35	938
45	565
55	147
65	6
75	2
85	0
90	0

Characteristics

Spacing Criteria = 1.2
Efficiency = 51.8%

Test No. H23496
C7242 7351LI
Lamp = 32W PLT
Lumens = 2400
26W Multiplier = 0.75
42W Multiplier = 1.33

Average Luminance

Angle	Value
0°	
45°	28008
55°	8983
65°	498
75°	271
85°	0

Cone of Light

Distance Fixture to Lighted Plane	Initial Footcandles at Nadir	Beam Diameter
6'0"	40	7'0"
7'6"	26	8'6"
8'0"	23	9'0"
10'0"	14	11'6"
13'0"	9	15'0"

Zonal Lumen Summary

Zone	Lumens	%Lamp	%Fixt
0-30	1131	23.6	45.5
0-40	1777	37.0	71.5
0-60	2476	51.6	99.6
0-90	2486	51.8	100.0
90-180	0	0.0	0.0
0-180	2486	51.8	100.0

Coefficients of Utilization

Ceiling	80%				70%				50%				30%				10%				0%
	70	50	30	10	70	50	30	10	50	30	10	50	30	10	50	30	10	50	30	10	0
Wall %	Zonal cavity method -- floor reflectance = 20%																				
RCR																					
0	62	62	62	60	60	60	60	58	58	58	55	55	55	53	53	53	53	52	52	52	52
1	58	56	55	54	57	55	54	53	53	52	51	51	50	50	49	49	48	47	47	47	47
2	55	51	49	47	53	51	48	46	49	47	45	47	46	44	46	44	43	42	42	42	42
3	51	47	44	41	50	46	43	41	45	42	40	43	41	40	42	40	39	38	38	38	38
4	48	43	39	37	47	42	39	36	41	38	36	40	37	35	39	37	35	34	34	34	34
5	44	39	35	33	43	39	35	33	38	35	32	37	34	32	36	33	32	31	31	31	31
6	41	36	32	29	41	35	32	29	35	31	29	34	31	29	33	31	29	28	28	28	28
7	39	33	29	27	38	33	29	26	32	29	26	31	28	26	31	28	26	25	25	25	25
8	36	30	27	24	36	30	27	24	30	26	24	29	26	24	28	26	24	23	23	23	23
9	34	28	25	22	34	28	24	22	27	24	22	27	24	22	26	24	22	21	21	21	21
10	32	26	23	20	32	26	23	20	25	22	20	25	22	20	25	22	20	19	19	19	19

DESCRIPTION

Low brightness 7-3/8" aperture downlight for use with a 26W, 32W or 42W Triple Twin Tube 4-pin compact fluorescent lamp. The precisely formed non-imaging optical reflector ensures 55° cutoff to lamp and lamp image and the one piece design eliminates light leaks at the ceiling. Standard features include low iridescent finish on all reflector colors to eliminate "rainbowing" and one electronic ballast to operate 26W, 32W or 42W TTT lamps. Venting ensures maximum lamp life and lumen output. Open downlight, open wall wash and lens trims are interchangeable within the same housing.

Catalog #	C7142E-7150LI-HB26	Type	B1
Project	PAUL MITCHEL SCHOOL	Date	11/19/2009
Comments			
Prepared by			

SPECIFICATION FEATURES

A ... Reflector

.050 thick aluminum, in a one piece spun parabolic contour. Available in a variety of Alzak® finishes. Also available with white or black baffle. Positive reflector mounting, without tools, pulls trim tight to ceiling.

B ... Trim Ring Options

Self flanged or molded white trim ring. Rimless or metal trim ring accessories available.

C ... Socket Connector

One piece die cast aluminum connection allows venting for maximum thermal performance.

D ... Housing Mounting Frame

One piece precision die cast aluminum 1-1/2" deep collar accommodates varying dimensions of ceiling materials.

E ... Universal Mounting Bracket

Accepts 1/2" EMT, C Channel, T bar fasteners, and bar hangers. Adjusts 5" vertically from above or below ceiling.

F ... Conduit Fittings

Die cast screw tight connectors.

G ... Junction Box

Listed for eight #12AWG (four in, four out) 90°C conductors feed through branch wiring.

1/2" and two 3/4" pry outs. Positioned to allow straight conduit runs. Access to junction box by removing reflector.

H ... Socket

4 pin GX24q-3/4 base with fatigue free stainless steel lamp spring ensures positive lamp retention.

I ... Electronic Ballast

Electronic ballast provides full light output and rated lamp life. Provides flicker free and noise free operation and starting.

Labels

cULus listed, standard damp label, IBEW union made.

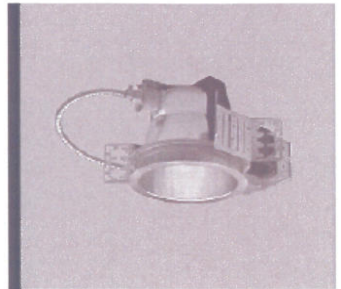

C7142 7151/7150

26W, 32W, 42W TTT Compact Fluorescent

7-3/8" OPEN DOWNLIGHT

26W Triple 4-pin
Ballast: Electronic
120V Input Watts: 29, Line Amps: 0.25
277 Input Watts: 26, Line Amps: 0.09
Power Factor: >.99, THD: <10%
Min. Starting Temp: -10°C (15°F)
Sound Rating: A

32W Triple 4-pin
Ballast: Electronic
120V Input Watts: 34.5, Line Amps: 0.30
277 Input Watts: 34.5, Line Amps: 0.13
Power Factor: >.99, THD: <10%
Min. Starting Temp: -10°C (15°F)
Sound Rating: A

32W Triple 4-pin
Ballast: Dimming
120V Input Watts: 39, Line Amps: 0.33
277 Input Watts: 37, Line Amps: 0.13
Power Factor: >.95, THD: <20%
Min. Starting Temp: 10°C (50°F)
Sound Rating: A

42W Triple 4-pin
Ballast: Electronic
120V Input Watts: 51.0, Line Amps: 0.30
Inrush Current Amps: 5.0
277 Input Watts: 51.0, Line Amps: 0.13
Inrush Current Amps: 9.0
Power Factor: >.99, THD: <10%
Min. Starting Temp: -10°C (15°F)
Sound Rating: A

NOTES:
Accessories should be ordered separately. For additional options, please consult your Cooper Lighting Representative. Alzak is a registered trademark of Aluminum Company of America. Hi-Lume is a registered trademark of Lutron Co., Inc.

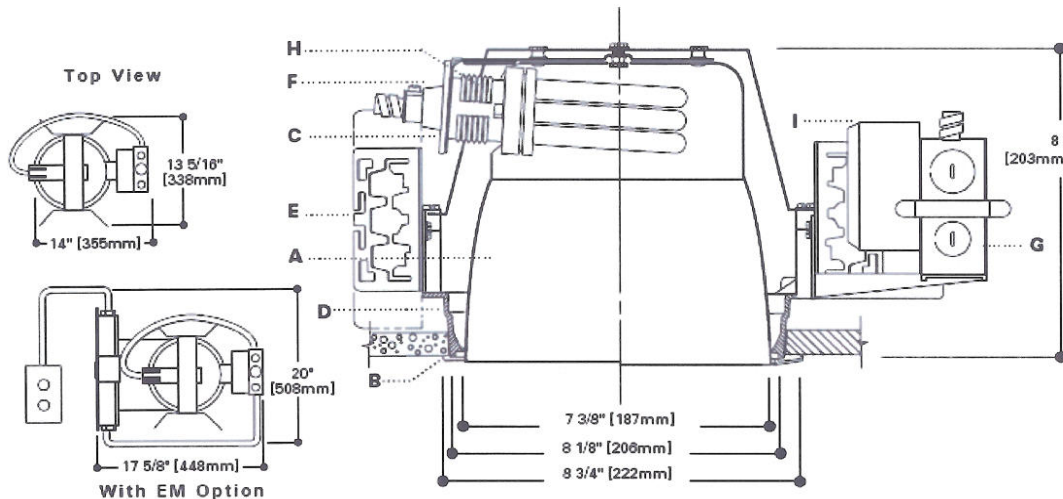

ORDERING INFORMATION

C7142E

C7	1	42	E	7150	LI	See Below
----	---	----	---	------	----	-----------

Housing C7: 7" Horizontal Lamp	Ballast E: 120/277V 50/60 Hz Electronic	Trims 7150: Molded Trim Ring	Finish LI: Low Iridescent Clear	Accessories HB26: C Channel Bar Hangers, 26" Long, Pair
Number of Lamps 1: 1 Lamp				
Wattage 42: 26W, 32W, or 42W TTT Lamp				

Candlepower Distribution

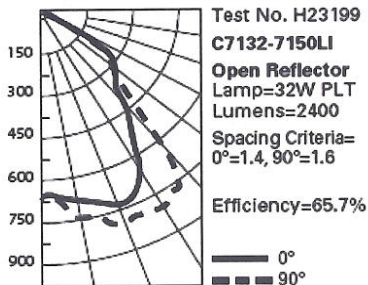

Candlepower

Deg.	CD	0°	90°
0	670	670	
5	678	696	
15	726	770	
25	743	818	
35	565	795	
45	334	372	
55	308	329	
65	0	0	
75	0	0	
85	0	0	
90	0	0	

Average Luminance

Deg	.CD/SQ M	0°	90°
45	17127	19082	
55	19471	20811	
65	549	515	
75	0	0	
85	0	0	

Cone of Light



Beam diameter is to 50% of maximum footcandles, rounded to the nearest half-foot.
 Footcandle values are initial, apply appropriate light loss factors where necessary.
 Lamp Multiplier: 32W TTT=.87
 Reflector Multiplier: Haze=.95, Straw=.9, Wheat=.9
 EM Multiplier (in emergency model) EM=.27

Zonal Lumen Summary

Zone	Lumens	%Lamp	%Luminaire
0-30	640	26.7	40.8
0-40	1074	44.7	68.1
0-60	1569	65.4	99.5
0-90	1577	65.7	100.0
90-180	0	0.0	0.0
0-180	1577	65.7	100.0

Coefficient of Utilization

rc	80%				70%			50%		30%		10%		0%	
	rw	70	50	30	10	50	30	10	50	10	50	10	50	10	0
RCR															
0	78	78	78	78	76	76	76	73	73	70	70	67	67	66	
1	74	72	70	68	71	69	67	68	65	65	63	63	62	60	
2	70	66	63	61	65	63	60	63	59	61	58	59	56	55	
3	66	61	57	54	60	57	54	58	53	57	52	55	51	50	
4	62	56	52	49	55	51	48	54	48	52	47	51	47	46	
5	58	51	47	44	51	46	43	49	43	48	43	47	42	41	
6	54	47	42	39	46	42	39	45	39	44	38	43	38	37	
7	50	42	38	34	42	38	34	41	34	40	34	39	34	33	
8	46	39	34	31	38	34	31	38	31	37	30	36	30	29	
9	43	35	31	27	35	30	27	34	27	34	27	33	27	26	
10	40	32	28	25	32	27	24	31	24	31	24	30	24	23	

rc=Ceiling reflectance, rw=Wall reflectance, RCR=Room cavity ratio
 CU Data Based on 20% Effective Floor Cavity Reflectance.

Candlepower Distribution

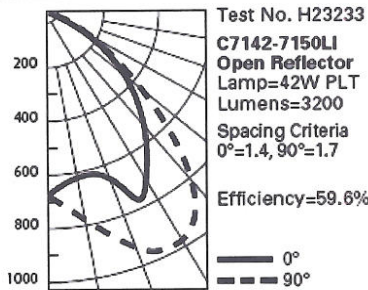

Candlepower

Deg.	CD	0°	90°
0	677	677	
5	641	720	
15	626	857	
25	799	958	
35	613	946	
45	438	531	
55	184	246	
65	12	13	
75	4	5	
85	1	1	
90	0	0	

Average Luminance

Deg	.CD/SQ M	0°	90°
45	22467	27238	
55	11636	15556	
65	1030	1116	
75	561	701	
85	416	416	

Cone of Light



Beam diameter is to 50% of maximum footcandles, rounded to the nearest half-foot.
 Footcandle values are initial, apply appropriate light loss factors where necessary.
 Lamp Multiplier: 42W TTT=.90
 Reflector Multiplier: Haze=.95, Straw=.90, Wheat=.90
 EM Multiplier (in emergency model) EM=.27

Zonal Lumen Summary

Zone	Lumens	%Lamp	%Luminaire
0-30	743	23.2	38.9
0-40	1287	40.2	67.4
0-60	1889	59.0	99.0
0-90	1909	59.6	100.0
90-180	0	0.0	0.0
0-180	1909	59.6	100.0

Coefficient of Utilization

rc	80%				70%			50%		30%		10%		0%	
	rw	70	50	30	10	50	30	10	50	10	50	10	50	10	0
RCR															
0	71	71	71	71	69	69	69	66	66	63	63	61	61	60	
1	67	65	64	62	64	62	61	61	59	59	57	57	56	55	
2	63	60	57	55	59	57	54	57	53	55	52	54	51	50	
3	59	55	52	49	54	51	49	53	48	51	47	50	46	45	
4	56	51	47	44	50	46	44	49	43	47	43	46	42	41	
5	52	46	42	39	46	42	39	45	39	44	38	43	38	37	
6	48	42	38	35	42	38	35	41	35	40	34	39	34	33	
7	45	38	34	31	38	34	31	37	31	36	30	35	30	29	
8	42	35	30	27	34	30	27	34	27	33	27	32	27	26	
9	39	31	27	24	31	27	24	31	24	30	24	29	24	23	
10	36	29	24	21	28	24	21	28	21	27	21	27	21	20	

rc=Ceiling reflectance, rw=Wall reflectance, RCR=Room cavity ratio
 CU Data Based on 20% Effective Floor Cavity Reflectance.

DESCRIPTION

Non-IC AIR-TITE™ fixture for use with H3 3" series trims. Housing is AIR-TITE with supplied gasket and prevents airflow between heated or air conditioned spaces and unconditioned attic areas. For use with 12V MR16 lamps

Non-IC Housing is AIR-TITE™ but insulation must be kept 3" away from all sides of housing.

Catalog #	H36LVTAT/3004WHC	Type	C
Project	Paul Mitchell, The School	Date	
Comments			
Prepared by	Wiedenbach-Brown		

DESIGN FEATURES

Housing

Formed of 20 gauge CRS with white powder coat finish.

Plaster Frame

Housing adjusts in plaster frame to accommodate up to 1-1/2" ceiling thickness. Galvanized steel construction.

Plaster frame features include:

- Regressed locking screw for securing hanger bars.
- Cutouts for easily crimping hanger bars in position.
- Halo name embossed on plaster frame. The housing may be removed from plaster frame to provide access to the junction box.

Junction Box

- UL Listed for through branch circuit wiring (maximum 8 No.12 ga., 90°C conductors).
- Four 1/2" trade size conduit knockouts with true pry-out slots are positioned to accommodate straight conduit runs.
- Three Slide-N-Side™ wire traps allow non-metallic sheathed cable to be installed

without tools and without removing knockouts. Accepts a wide range of non-metallic sheathed cable.

- Allows wiring connections to be made outside the junction box
- Simply insert the cable directly into the trap after connections are made.
- Accommodates the following standard non-metallic sheathed cable sizes: (US) #14/2, #14/3, #12/2, #12/3 (Canada) #14/2, #14/3, #12/2

Got NAIL!™ Bar Hangers

- Pre-installed nail easily installs in regular lumber, engineered lumber and laminated beams.
- Safety and guidance system prevents snagging, ensures smooth straight nail penetration and allows bar hangers to be easily removed if necessary.
- Automatic levelling flange aligns the housing and lets you hold the housing in place with one hand while driving nails.
- Housing can be positioned at any point within 24" joist span
- Pass-N-Thru™ feature allows

bar hangers to be shortened without removing from plaster frame.

- Score lines allow "toolless" shortening for 12" joists.
- Bar hangers may be repositioned 90°.
- Integral T-bar clip snaps onto T-bars - no additional clips required.

Transformer

Integral magnetic transformer steps 120V line voltage down to 12V lamp operating voltage.

Socket

GU5.3 socket for 12V MR16 lamps

Labels

- UL/cUL Listed
- Damp Location Listed
- Listed for Feed Through
- Certified Under ASTM-E283 for air tight construction

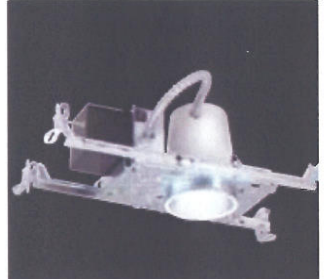

H36LVTAT 3" Non-IC AIR-TITE™ Recessed Housing 12V MR16

3" TRIMS



FOR USE IN
NON-INSULATED
CEILING

CAN BE USED IN
INSULATED CEILING
BUT INSULATION
MUST BE KEPT 3"
FROM ALL SIDES OF
THE HOUSING

air-tite™

with all trims listed



FEATURES:

- SLIDE-N-SIDE™ JUNCTION BOX
- GOT NAIL!™ BAR HANGERS
- PASS-N-THRU™ BAR HANGERS
- REGRESSED LOCKING SCREW
- HALO ID ON PLASTER FRAME

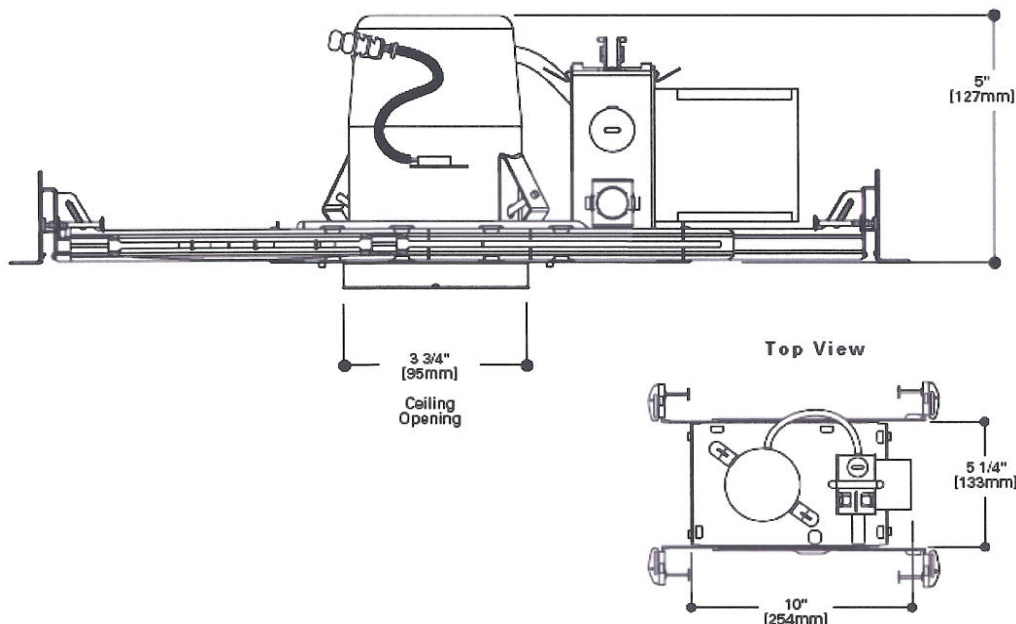

TRIMS

ORDERING INFORMATION

SAMPLE NUMBER: H36LVTAT-3001WHBB
 Order housing, trim and accessories separately.

Housing

H36LVTAT

H36LVTAT=3" AIR-TITE™ Non-IC
 Small Aperture Low
 Voltage MR16
 Housing

Trims

3004WHC

Note: Consult individual trim specification sheets for additional information and color views



Adjustable Pinhole Baffle
 50W 12V MR16
 3001WHBB=White with Black Baffle
 3001BKBB=Black with Black Baffle
 3001SNBB=Satin Nickel with Black Baffle
 3001ACBB=Antique Copper with Black Baffle
 3001TBZBB=Tuscan Bronze with Black Baffle
 OD: 4 1/4" (108mm)



Adjustable Pinhole Reflector
 50W 12V MR16
 3002WHC=White with Clear Reflector
 3002BKC=Black with Clear Reflector
 3002SNC=Satin Nickel with Clear Reflector
 3002ACC=Antique Copper with Clear Reflector
 3002TBZC=Tuscan Bronze with Clear Reflector
 OD: 4 1/4" (108mm)



Adjustable Baffle
 50W 12V MR16
 3003WHBB=White with Black Baffle
 3003WHWB=White with White Baffle
 3003BKBB=Black with Black Baffle
 3003SNB=Satin Nickel with Satin Nickel Baffle
 3003ACB=Antique Copper with Antique Copper Baffle
 3003TBZB=Tuscan Bronze with Tuscan Bronze Baffle
 OD: 4 1/4" (108mm)



Adjustable Reflector
 50W 12V MR16
 3004WHC=White with Clear Reflector
 3004BKC=Black with Clear Reflector
 3004SN=Satin Nickel with Satin Nickel Reflector
 3004AC=Antique Copper with Antique Copper Reflector
 3004TBZ=Tuscan Bronze with Tuscan Bronze Reflector
 OD: 4 1/4" (108mm)



Crossblade Reflector
 50W 12V MR16
 3005WHC=White with Clear Reflector
 3005BKC=Black with Clear Reflector
 OD: 4 1/4" (108mm)



Adjustable Slot Aperture
 50W 12V MR16
 3006WHBB=White with Black Baffle
 3006BKBB=Black with Black Baffle
 3006SNBB=Satin Nickel with Black Baffle
 3006ACBB=Antique Copper with Black Baffle
 3006TBZBB=Tuscan Bronze with Black Baffle
 OD: 4 1/4" (108mm)



Regressed Lens Showerlight - wet location listed
 50W 12V MR16
 3007WHC=White with Clear Reflector
 3007PC=Polished Chrome with Clear Reflector
 3007SN=Satin Nickel with Satin Nickel Reflector
 3007AC=Antique Copper with Antique Copper Reflector
 3007TBZ=Tuscan Bronze with Tuscan Bronze Reflector
 OD: 4 1/4" (108mm)

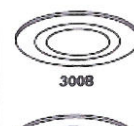

Showerlight - wet location listed
 50W 12V MR16
 3008FG=White Polymer with Glass Lens with Frosted Perimeter
 OD: 4 1/4" (108mm)



Adjustable Gimbal
 50W 12V MR16
 3009WHBB=White with Black Baffle
 3009WHWB=White with White Baffle
 3009BKBB=Black with Black Baffle
 3009SNBB=Satin Nickel with Black Baffle
 3009ACBB=Antique Copper with Black Baffle
 3009TBZBB=Tuscan Bronze with Black Baffle
 OD: 4 1/4" (108mm)

Note: Specifications and Dimensions subject to change without notice.

Visit our web site at www.cooperlighting.com

DESCRIPTION

The new Class R2 Series by Corelite offers a shallow recessed design, ideal for plenum-restricted applications and low-ceiling environments. The Class R2 Series has been optically engineered to provide low-brightness ambient illumination and to accommodate a variety of innovative shielding options, including a unique linear prismatic frosted lens, bladed micro baffle, and two styles of perforated overlays. The dedicated T5 design of the Class R2 Series offers superior lumens per watt when compared with traditional 3T8 or twin tube luminaires.

Catalog	R2-W-L-2T5-1-C-24-UNV / DW-24-W	Type	D1/D1F
Project	PAUL MITCHELL SCHOOL	Date	
Comments			
Prepared by			

SPECIFICATION FEATURES

A ... Construction

Low profile housing die-formed 20 gauge cold rolled steel with integral one-piece 20 gauge gear tray. Optional welded and gasketed construction available for NY and Chicago Plenum applications. Air Return also available.

B ... Reflectors

High reflectance white powder coat painted reflector system.

C ... Shielding

Linear prismatic co-extruded acrylic lens with fully frosted center and clear/frost blended lens returns. Lens is designed to provide low glare ambient illumination while creating evenly luminous side reflectors. Lens secured to housing via injection molded inserts for easy lamp access.

D ... Electrical

Fixtures are prewired with quick wire connectors and use UL listed Class P, T5 program rapid start universal voltage electronic ballasts (High output or normal output). Power factor of 97% with less than 10% THD. Fixtures and electrical components certified to UL and CUL standards.

E ... Finish

Fixture housings are standard white using electrostatically applied polyester powder coat paint.

Mounting

Standard flange design works with most lay-in ceiling types. Integral pryout tabs secure luminaire to ceiling grid from above. Fixture offers tie-in locations for tie-wire on all corners, consult local code for appropriate tie-wire recommendations.

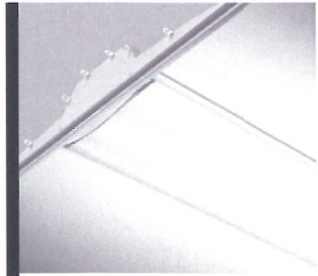

CLASS R2 Lensed

2T5
2T5HO

2'x4' Shallow Recessed
2-7/8" Depth

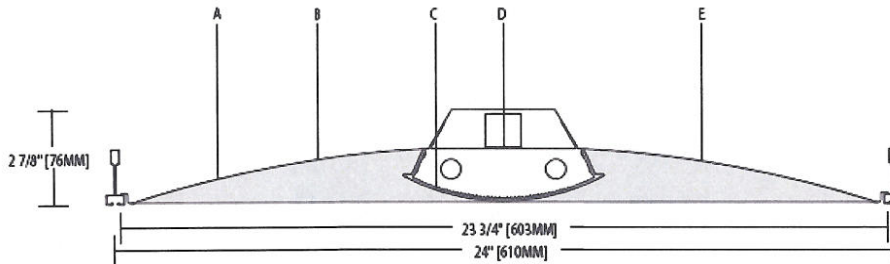

ORDERING INFORMATION

Sample Number: R2-W-L-2T5-1-C-UNV-24-T1

R2	W	L	2	N5	1	C	UNV	24		
Series R2: Class R2	Reflector W: White	Shielding L: Lens	Number of Lamps 2: 2 Lamps	Lamp Type T5: T5 High Output N5: T5 Normal Output	Number of Circuits ¹ 1: 1 Circuit 2: 2 Circuit	Wiring ¹ C: Standard Circuit D: Dimming E: Emergency B: Battery Pack T: Nightlight Y: Daylight S: Step Dimming	Voltage ¹ 120= 120V 277= 277V 347= 347V UNV: Universal (120V-277V)	Size 24: 2' x 4'	Ceiling Type T1: 1" Grid, Slot Grid, 9/16" Tegular T9: 9/16" Grid	Options ¹ AR: Air Return CP: Chicago Plenum NY: New York City Construction AM: Anti-Microbial Coating LG: Lens Gasketing W6: 6' Whip Flex W12: 12' Whip Flex

Notes: 1 Not all options available. Please consult your Cooper Lighting Representative for availability. Specifications and dimensions subject to change without notice.

D1F = WITH FLANGE KIT
#DW-24-W

DESCRIPTION

The new Class R2 Series by Corelite offers a shallow recessed design, ideal for plenum-restricted applications and low-ceiling environments. The Class R2 Series has been optically engineered to provide low-brightness ambient illumination and to accommodate a variety of innovative shielding options, including a unique linear prismatic frosted lens, bladed micro baffle, and two styles of perforated overlays. The dedicated T5 design of the Class R2 Series offers superior lumens per watt when compared with traditional 3T8 or twin tube luminaires.

Catalog	R2-W-L-3T5-1-C-24-UNV / DW-24-W	Type	D6F
Project	PAUL MITCHELL SCHOOL	Date	
Comments			
Prepared by			

SPECIFICATION FEATURES

A ... Construction

Low profile housing die-formed 20 gauge cold rolled steel with integral one-piece 20 gauge gear tray. Optional welded and gasketed construction available for NY and Chicago Plenum applications. Air Return also available.

B ... Reflectors

High reflectance white powder coat painted reflector system.

C ... Shielding

Linear prismatic co-extruded acrylic lens with fully frosted center and clear/frost blended lens returns. Lens is designed to provide low glare ambient illumination while creating evenly luminous side reflectors. Lens secured to housing via injection molded inserts for easy lamp access.

D ... Electrical

Fixtures are prewired with quick wire connectors and use UL listed Class P, T5 program rapid start universal voltage electronic ballasts (High output or normal output). Power factor of 97% with less than 10% THD. Fixtures and electrical components certified to UL and CUL standards.

E ... Finish

Fixture housings are standard white using electrostatically applied polyester powder coat paint.

Mounting

Standard flange design works with most lay-in ceiling types. Integral pryout tabs secure luminaire to ceiling grid from above. Fixture offers tie-in locations for tie-wire on all corners, consult local code for appropriate tie-wire recommendations.

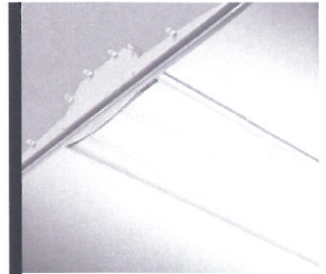

CLASS R2 Lensed

2T5
2T5HO

2'x4' Shallow Recessed
2-7/8" Depth

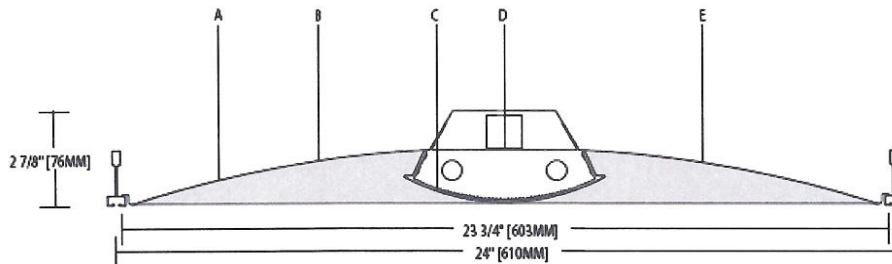

ORDERING INFORMATION

Sample Number: R2-W-L-2T5-1C-UNV-24-T1

R2	W	L	2	N5	1	C	UNV	24		
Series R2: Class R2	Reflector W: White	Shielding L: Lens	Number of Lamps 2: 2 Lamps	Lamp Type T5: T5 High Output N5: T5 Normal Output	Number of Circuits ¹ 1: 1 Circuit 2: 2 Circuit	Wiring ¹ C: Standard Circuit D: Dimming E: Emergency B: Battery Pack T: Nightlight Y: Daylight S: Step Dimming	Voltage ¹ 120: 120V 277: 277V 347: 347V UNV: Universal (120V-277V)	Ceiling Type T1: 1" Grid, Slot Grid, 9/16" Tegular T9: 9/16" Grid	Options ¹ AR: Air Return CP: Chicago Plenum NY: New York City Construction AM: Anti-Microbial Coating LG: Lens Gasketing W6: 6' Whip Flex W12: 12' Whip Flex	
								Size 24: 2' x 4'		

Notes: ¹ Not all options available. Please consult your Cooper Lighting Representative for availability. Specifications and dimensions subject to change without notice.

D1F = WITH FLANGE KIT
#DW-24-W

DESCRIPTION

The W Series wraparound features economy and energy efficient performance. The luminaire's characteristic clean, low profile design is both appealing and practically functional. The W Series utilizes a clear, low brightness, extruded acrylic refractor and a heavy gauge steel end plate with embossed light seal for dependable performance and good looks.

APPLICATION

The efficient and economical W Series is the perfect wraparound for commercial spaces, schools, dormitories, offices and retail areas.

SPECIFICATION FEATURES

A... Construction

Housing die formed code gauge prime cold rolled steel. Six full length ribs for strength. Ballast cover easily removed without tools. Steel end plates with 7/8" KO and light-seal embossment. Couplers for continuous row mounting.

B... Electrical*

Ballasts are CBM/ETL Class "P" and are positively secured by mounting bolts. Pressure lock lampholders. UL/CUL listed. Suitable for damp locations.

C... Finish

Multistage, iron phosphate pre-treatment ensures maximum bonding and rust inhibitor. Lighting grade, baked white enamel finish.

D... Frame/Shielding

100% clear virgin acrylic refractor/lens. Sides have inside linear prisms and bottom has pyramidal prisms for low brightness control. Lens can be hinged from either side in a lift and shift manner.

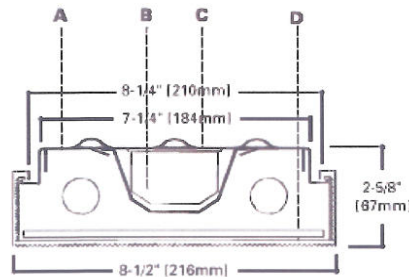

MOUNTING DATA

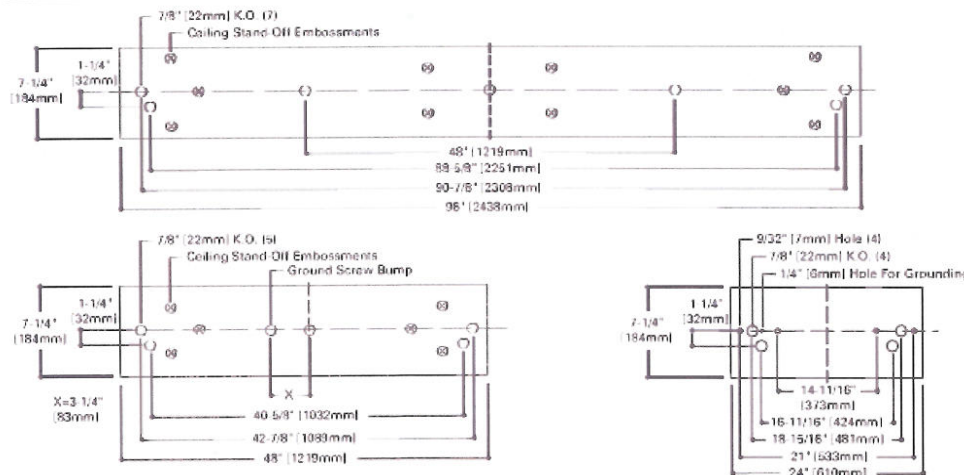

LAMP CONFIGURATIONS

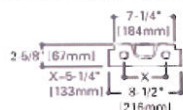

LIFT & SHIFT REFRACTOR

Easily Removed. Hinges Either Side (Not Recommended For Sloped Ceiling Applications.)

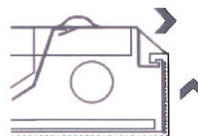

COOPER LIGHTING

Catalog #	W-232A-UNV-EB81-U	Type	E
Project	Paul Mitchell, The School		
Comments			
Prepared by	Wiedenbach-Brown	Date	

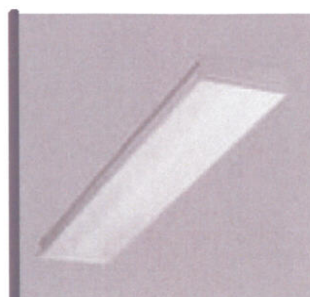

W220
217
240
232

2' SURFACE
2 LAMPS LTS OR HTS
4' OR 8' SURFACE
2 LAMPS
Commercial Wrap

ENERGY DATA

Input Watts:
EB Ballast & STD Lamps
217 (36)
240 (72)
232 (61)

ES Ballast & STD Lamps
220 (58)
217 (45)
240 (86)
232 (71)

Luminaire Efficacy Rating
LER = FW-72
Catalog Number: W-232A

Yearly Cost of 1000 lumens,
3000 hrs at .08 KWH = \$3.33

*Reference the lamp/ballast data in the Technical Section for specific lamp/ballast requirements.

ADF020676
(Supersedes ADF991800)



PHOTOMETRICS

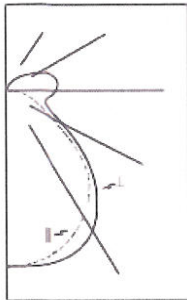

W-232A
Energy Saving
Ballast

F32T8/35K Lamps
2850 Lumens

Spacing criterion:
(H) 1.3 x mounting
height, (L) 1.4 x
mounting height
Efficiency 80.5%

Test Report:
W232A.IES

LER = FW-72

Yearly Cost of 1000
lumens, 3000 hrs at
.08 KWH = \$3.33

Coefficients of Utilization

rc	Effective floor cavity reflectance																					
	80%				70%				20%													
rw	70	50	30	10	70	50	30	10	50	30	10	50	30	10	50	30	10	50	30	10	0	
RCR	0	92	92	92	92	88	88	88	88	81	81	81	75	75	75	68	68	68	66	66	66	66
	1	84	80	77	74	80	77	74	71	71	69	66	65	63	62	60	59	57	55	55	55	55
	2	77	71	66	61	74	68	63	59	63	59	56	58	55	52	54	51	49	47	47	47	47
	3	71	63	57	52	68	61	55	51	56	52	48	52	48	45	48	45	43	40	40	40	40
	4	65	56	50	45	62	54	48	43	50	45	41	47	43	39	43	40	37	35	35	35	35
	5	60	50	43	38	57	48	42	37	45	40	36	42	37	34	39	35	32	30	30	30	30
	6	55	45	38	33	53	43	37	32	40	35	31	38	33	30	35	31	28	26	26	26	26
	7	51	40	34	29	49	39	33	28	37	31	27	34	29	26	32	28	25	23	23	23	23
	8	47	36	30	25	45	35	29	25	33	28	24	31	26	23	29	25	22	20	20	20	20
	9	43	33	26	22	41	32	26	21	30	24	21	28	23	20	26	22	19	17	17	17	17
	10	40	30	23	19	38	29	23	19	27	22	18	25	21	17	24	20	17	15	15	15	15

Zonal Lumen Summary

Zone	Lumens	%Lamp	%Fixture
0-30	1077	18.9	23.5
0-40	1775	31.1	38.7
0-60	2960	51.9	64.5
0-90	3739	65.6	81.4
90-180	852	14.9	18.6
0-180	4591	80.5	100.0

Typical VCP Percentages

Room Size (Ft.)	Height Along		Height Across	
	8.5'	10.0'	8.5'	10.0'
20 x 20	65	70	63	70
30 x 30	58	62	53	60
30 x 60	50	53	37	43
60 x 30	59	63	56	62
60 x 60	50	53	39	44

Candela

Angle	Along H	45°	Across L
0	1328	1328	1328
10	1307	1324	1336
20	1238	1296	1334
30	1122	1211	1249
40	950	1023	1034
50	667	749	738
60	364	451	441
70	200	277	310
80	108	189	325
90	10	155	374
100	11	241	389
110	12	232	344
120	13	166	253
130	13	106	164
140	14	59	92
150	14	35	51
160	15	25	32
170	15	17	19
180	13	13	13

ORDERING INFORMATION

SAMPLE NUMBER: W-232A-120V-EB81-U

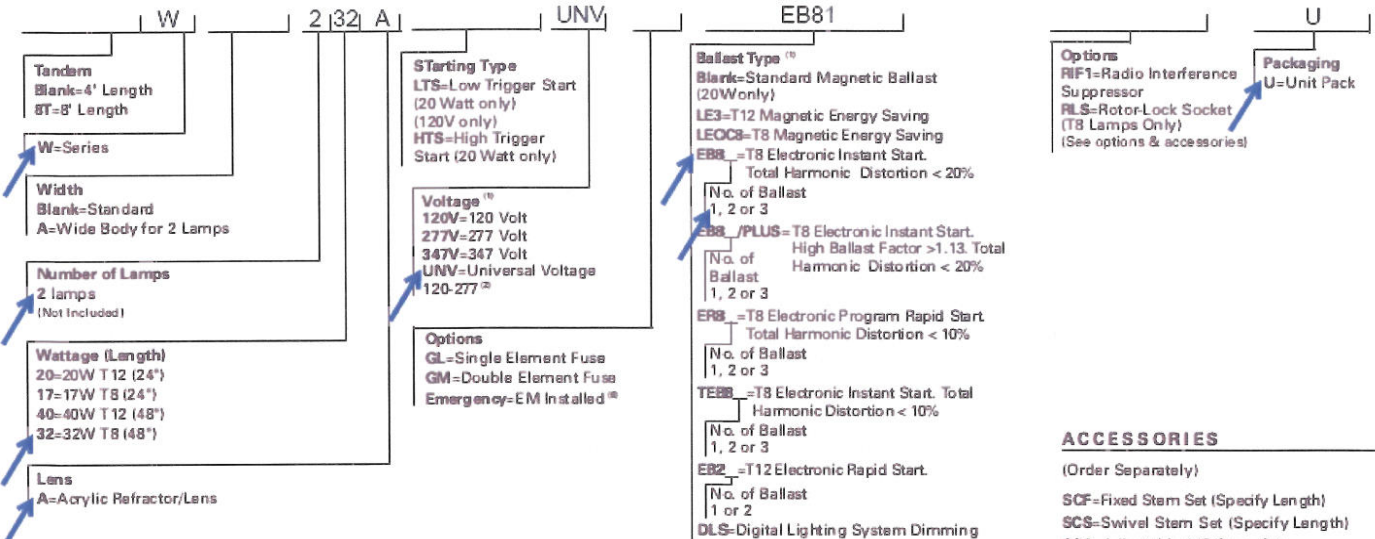

NOTES: ⁽¹⁾ Products also available in non US voltages and frequencies for international markets. ⁽²⁾ Not available when specifying emergencies, voltage must be specific. ⁽³⁾ Stem mounting not available on 3 lamp fixtures. ⁽⁴⁾ 2 point suspension recommended for 2 and 4 lamp fixtures. ⁽⁵⁾ Steel endplates with 7/8" KO standard for continuous row mounting. ⁽⁶⁾ Non available for 2' version.

For complete product data, reference the Fluorescent Specification binder Specifications & dimensions subject to change without notice. Consult your Cooper Lighting Representative for availability and ordering information.

LAMP SPACING (8")

(2 Lamp Housing with 8" lamp spacing also available.)

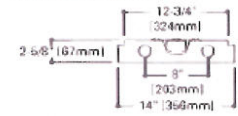

Catalog Number
W-A-232A (120V or 277V)

ACCESSORIES

(Order Separately)
SCF=Fixed Stem Set (Specify Length)
SCS=Swivel Stem Set (Specify Length)
SCA=Adjustable 48" Stem Set
A1B/Spacer-U=Spacer 1-1/2" to 2-1/2" from ceiling (Use 2 per fixtures)
Lengths Available: 6, 8, 12, 18, 24, 36, 48
Additional Accessories Available. See Options and Accessories Section.

SHIPPING INFORMATION

Catalog No.	Wt.
W-217A	8 lbs.
W-232A	17 lbs.
8TW-232A	33 lbs.



tab & spine
evolution™

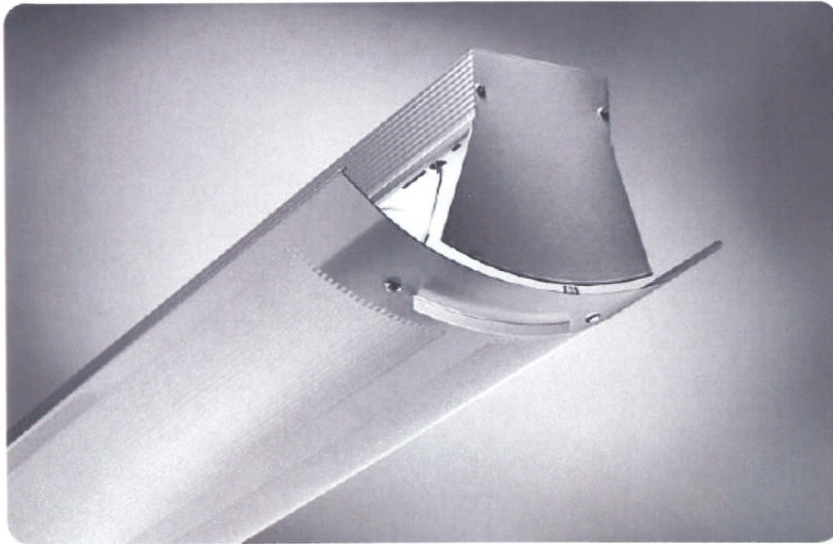

Type G
Paul Mitchell, The School

FOCAL POINT®

FEATURES

Suspended or surface linear direct/Indirect fluorescent with perforated shielding.

Ribbed aluminum housing creates distinctive aesthetic.

Perforated shield includes micro-perforations for soft illumination

Excellent choice for applications requiring an industrial aesthetic.

DIMENSIONAL DATA

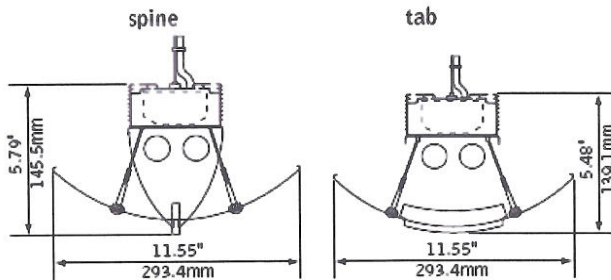

lamping options

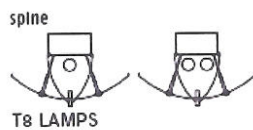
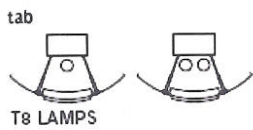

fixture information

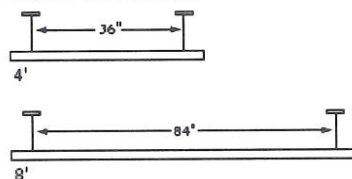

shielding options

tab



spine

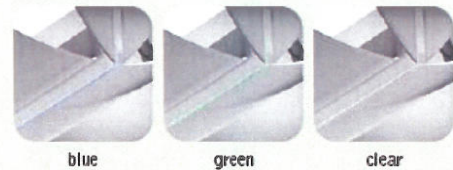

PERFORMANCE

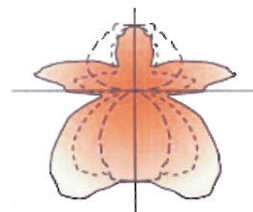

Acrylic Blue Tab
 2-Lamp T8
 41% Efficiency
 477 cd @ 35°
 45% Indirect
 55% Direct

See Photometric section for additional performance data.

fixture type:
project name:

MOUNTING INFORMATION

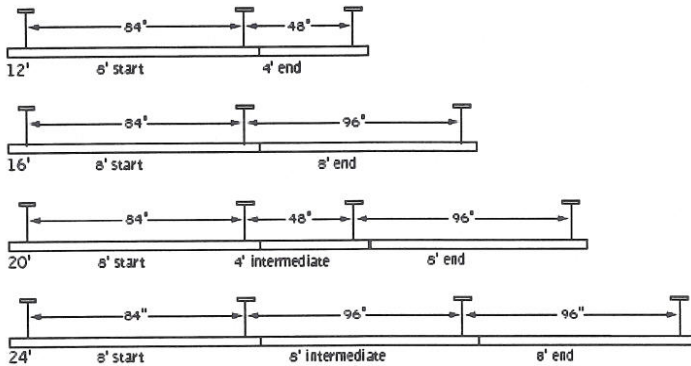

Consult factory for additional row length information.

SPECIFICATIONS

construction

One-piece, .090" thick channel housing of 6063-T6 extruded aluminum.
22 Ga. steel ballast cover allows for easy access to ballast.
Tab or Spine acrylic insert are mechanically attached to perforated shield.
For row installation, die-formed 18 Ga. steel internal coupler mechanically fastens to adjoining luminaires, forming hairline joint.
All luminaires are provided with single point aircraft cable suspension.

4' unit weight: 13 lbs.
8' unit weight: 23 lbs.

optic

Tab and Spine shielding: two bands 5.75"W x 41.25"L round perforations with white acrylic insert.
Round perforations are .0625" dia on .125" centers.

electrical

Luminaires are pre-wired with factory installed branch circuit wiring with over-molded quick connects.
Factory installed SJT power cord at feed location is included.
Electronic ballasts are thermally protected and have a Class "P" rating.
Optional DALI and other dimming ballasts available.
Consult factory for dimming specifications and availability.
UL and cUL listed.

emergency

Emergency battery packs provide 90 minutes of illumination.
Initial lumen output for lamp types are as follows:

T8 Lamps: Up to 475 lumens

Battery pack requires unswitched hot from same branch circuit as AC ballast.

finish

Polyester powder coat applied over a 5-stage pretreatment.
Extruded aluminum channel, perforated shield and steel end caps are painted with powder coat paint finish Titanium Silver.
Canopy finished in Matte Satin White.

ORDERING

luminaire series	Evolution	FEVS
shielding	Acrylic Blue Tab	BT
	Acrylic Green Tab	GT
	Acrylic Clear Tab	CT
	Acrylic Blue Spine	BS
	Acrylic Green Spine	GS
	Acrylic Clear Spine	CS
lamping	One Lamp T8	1T8
	Two Lamp T8	2T8
circuits	Single Circuit	1C
	Dual Circuit (Multiple lamp fixtures only)	2C
voltage	120 Volt	120
	277 Volt	277
	347 Volt	347
	(Consult factory for availability)	
ballast	Electronic Instant Start <20% THD	E
	Electronic Program Start <10% THD	S
	Electronic Dimming Ballast (Consult factory for dimming availability)	D
mounting	24" Cable Suspension	C24
	48" Cable Suspension	C48
	96" Cable Suspension (Specify "J" in place of "C" for 5" dia. canopies at power-feed and 2" dia. canopies at non-feed locations) (Consult factory for sloped ceiling applications)	C96
	Ceiling Surface Mount	SM
factory options	Emergency Circuit	EC
	Emergency Battery Pack	EM
	HLR/GLR Fuse	FU
	Include 3000K Lamp	L830
	Include 3500K Lamp	L835
	Include 4100K Lamp	L841
finish	Titanium Silver	TS
luminaire length	4'	4'
	8'	8'
	12' (8'+4')	12'
	16' (8'+8')	16'
	20' (8'+4'+8')	20'
	24' (8'+8'+8')	24'
	(Longer run lengths available; consult factory for availability.)	

LINEAR

Focal Point L.L.C. 4201 South Pulaski Rd, Chicago, Illinois 60632 | T: 773.247.9494 | F: 773.247.9494 | info@focalpointlights.com | www.focalpointlights.com
Focal Point L.L.C. reserves the right to change specifications for product improvement without notification.



Filename: FEVSBT2Ts.IES
 Catalog #: FEVS-BT-2Ts-1C-120-E-C24-TS-4'
 Efficiency: 41%
 Test #: 11035.0

CANDLEPOWER DISTRIBUTION

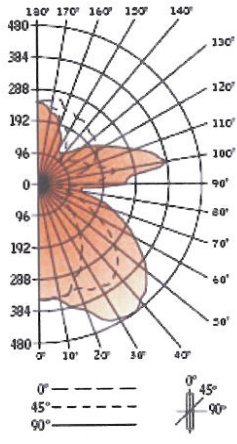

Spacing 1.2
 Criterion: 1.8

Vertical Angle	Horizontal Angle				Zonal Lumens
	0°	22.5°	45°	67.5°	
0°	344	344	344	344	344
5°	346	346	346	346	33
15°	340	342	345	369	101
25°	288	289	351	423	166
35°	228	252	366	449	223
45°	154	205	327	410	240
55°	97	147	252	336	217
65°	43	76	169	250	164
75°	15	42	100	156	105
85°	0	34	61	112	74
90°	0	81	166	231	249
95°	13	96	193	246	185
105°	129	76	199	307	217
115°	186	73	148	229	168
125°	207	108	120	174	136
135°	217	163	97	129	145
145°	232	187	148	115	98
155°	243	213	193	171	90
165°	264	253	229	217	67
175°	252	250	249	244	24
180°	248	248	248	248	248

LUMEN SUMMARY

Zone	Lumens	% Lamp	% Fixt	
0°-30°	299	5.1	12.4	
0°-90°	1321	22.4	54.7	
90°-130°	706	12.0	29.2	
90°-180°	1094	18.5	45.3	
Total Luminaire	0°-180°	2415	40.9	100.0

LUMINANCE DATA (CD/M²)

Vertical Angle	0°	45°	90°
45°	594	964	1300
55°	461	832	1208
65°	27	656	1107
75°	158	490	882
85°	0	422	899

CO-EFFICIENTS OF UTILIZATION

Floor	80				70				50				30				10				00			
	70	50	30	10	70	50	10	50	10	50	10	50	10	50	10	50	10	50	10	50	10	50	10	
RCR 0	44	44	44	44	41	41	41	35	35	30	30	25	25	22	18	18	18	15	15	11	11	09	09	
1	40	38	37	35	7	36	33	30	28	26	24	21	20	18	17	14	13	11	11	09	07	06	05	
2	37	33	31	28	34	31	27	27	23	23	20	19	17	15	13	11	10	09	08	07	06	05	04	
3	33	29	26	24	31	27	22	23	20	20	17	17	14	13	11	10	09	08	07	06	05	04	03	
4	30	26	22	20	28	24	19	21	17	18	14	15	12	11	10	09	08	07	06	05	04	03	02	
5	28	23	19	17	26	21	16	18	14	16	12	13	10	09	08	07	06	05	04	03	02	01	01	
6	25	20	17	14	24	19	14	16	12	14	11	12	09	08	07	06	05	04	03	02	01	01	00	
7	23	18	15	13	22	17	12	15	10	13	09	11	08	07	06	05	04	03	02	01	01	00	00	
8	22	16	13	11	20	15	10	13	09	11	08	09	07	06	05	04	03	02	01	01	00	00	00	
9	20	15	12	09	18	14	09	12	08	10	07	08	06	05	04	03	02	01	01	00	00	00	00	
10	19	13	10	08	17	13	08	11	07	09	06	08	05	04	03	02	01	01	00	00	00	00	00	

Numbers indicate percentage values of reflectivity.

COOPER LIGHTING - LUMARK®

DESCRIPTION

Lumark's Vaportight fixtures are designed for heavy-duty, non-corrosive environments. Applications include processing plants, cold storage, foundries, factories, loading docks and retail applications. U.L and CUL listed for non-classified wet locations. For use in 40°C ambient environments.

Catalog #	ICVC1G	Type	H
Project	Paul Mitchell, The School	Date	
Comments			
Prepared by	Wiedenbach-Brown		

SPECIFICATION FEATURES

A ... Housing

Housings and threaded guard are die-cast aluminum. Small housing utilizes 1/2" NPS entry while large housing use 3/4" NPS entry. Standard construction includes thru-way wiring for ceiling and wall mount units. Guard is one piece and features stainless steel locking screw for vandal resistance.

B ... Gasket

Silicone gasket provides long-life vapor seal.

C ... Socket

Sockets are medium-base, porcelain exterior with 150°C wire.

D ... Globe

Globe is heat- and impact-resistant glass and accepts up to 200W incandescent in small housing and 300W incandescent in the large housing.

E ... Mounting

Optional pendant mount, wall or ceiling mounting. Wall mount fits 4" round or octagonal J-Box. Pendant mount utilizes 1/2" NPS for small and 3/4" NPS for large.

F ... Finish

Standard finish is polyester powder coat grey.



IC VAPORTIGHT

200 - 300W
Incandescent

INDUSTRIAL
SAFETY AND SECURITY
LUMINAIRE

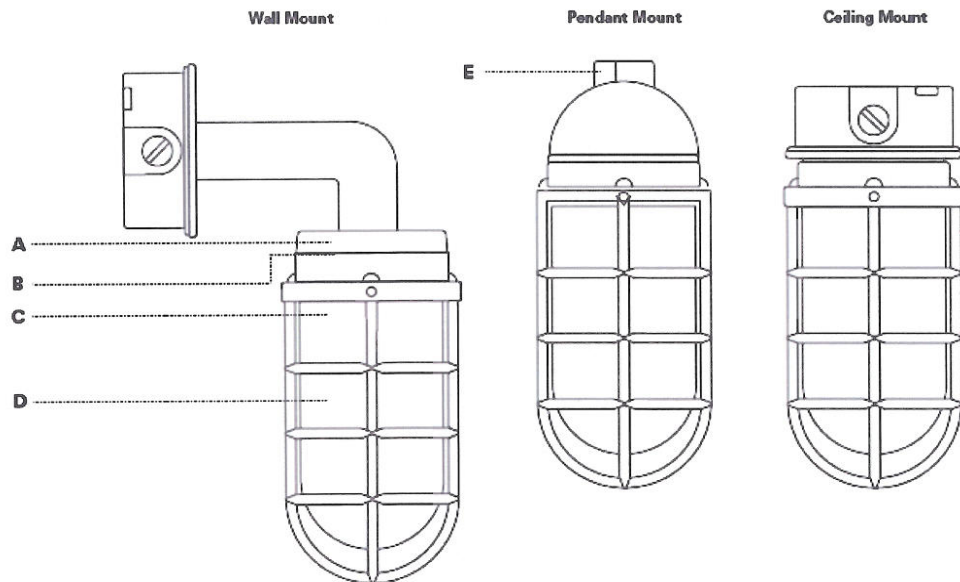

DIMENSIONS

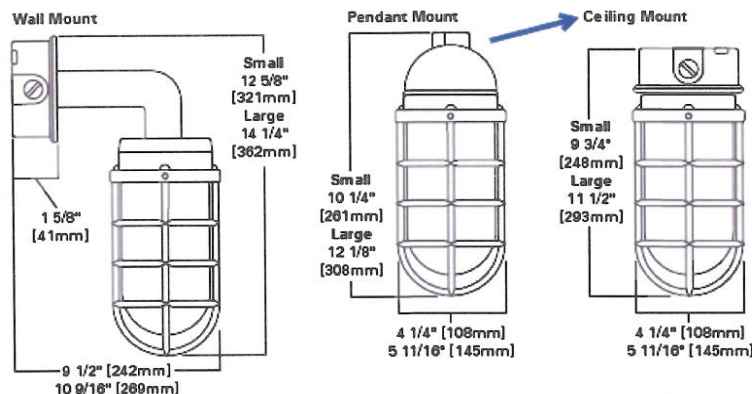

TECHNICAL DATA

40°C Ambient Environment
IP65

SUPPLY WIRE RATINGS

75°C (ICVW1)
90°C (ICVW2)
90°C (ICVP1/ICVP2)
90°C (ICVC1/ICVC2)

SHIPPING DATA

Approximate Net Weight:
5 lbs. (2 kgs.)



ORDERING INFORMATION

ICVC1G



Lamp Type
IC: Incandescent

Mounting
VC: Ceiling

Lamp Wattage ¹
1: 200W²

Guard
G: Guard

- Notes: 1 Care must be taken in selecting lamps due to size variations by manufacturers.
 2 A21 lamp maximum. Lamp not included.
 3 Standard finish is polyester powder coat gray with inside painted white.
 4 Guard required to install.
 5 Order separately.

ACCESSORIES

Concentric Dome (DC1, DC2)

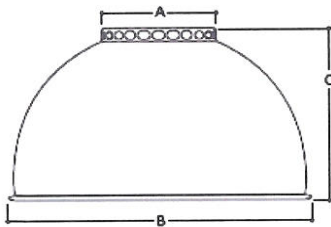

Angle Dome (DA1, DA2)

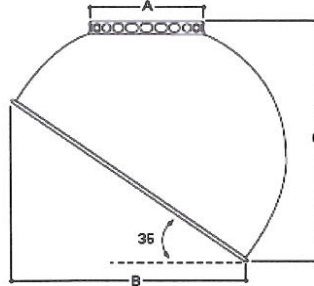

Concentric Dome	A	B	C
DC1	4 3/8" [111mm]	11 3/4" [298mm]	6 7/8" [175mm]
Angle Dome	A	B	C
DA1	5 13/16" [148mm]	11 3/16" [285mm]	12 3/4" [324mm]

COOPER LIGHTING - LUMARK®

DESCRIPTION

The BenchMark HB ECON(TM) technology prismatic high-bay utilizes a durable heavy-duty die cast aluminum ballast housing and prismatic acrylic reflector for maximum durability and photometric performance. U.L. listed and CSA certified. Damp location standard.

The BenchMark HB prismatic high-bay is perfect for retail stores, wholesale warehouses, grocery chains, malls and auto showrooms.

Catalog #	MD-HB-PD16-M-100E-SHK-PC3	Type	J100
Project	Paul Mitchell, The School	Date	
Comments			
Prepared by	Wiedenbach-Brown		

SPECIFICATION FEATURES

A ... Mounting

Easy slide-on die-cast aluminum mounting box with tapped opening for 3/4" conduit.

B ... Housing

Durable heavy-duty die-cast aluminum housing for lasting performance in the harshest environments. Integrally hinged for ease of maintenance with optional toolless entry. Finished in a white polyester powder coat.

C ... Ballast

ECON(TM) electronic ballast technology delivers longer lamp life and improved lumen output while maintain constant lamp wattage. End of life circuitry prevents high voltage H.I.D. lamps minimizing non-passive lamp failures. Color shift minimized though improved starting and operations. Thermal monitoring circuitry prevents abnormal high ambient conditions damage to the ballast. Minimum starting temperature is -40°C (-40°F).

D ... Universal Brackets

Universal ladder brackets allow for the flexibility to change out with other reflectors available in spun aluminum.

E ... Socket

Mogul-base porcelain socket.

F ... Reflector System

Easily mounted prismatic acrylic reflector has multiple field-adjustable distribution patterns for precision control.



HB
16" 22" & 25"
PRISMATIC
BENCHMARK

250-400W
Pulse Start Metal

DIE-CAST ALUMINUM
PRISMATIC HIGH-BAY
HEAVY DUTY INDUSTRIAL
LUMINAIRE

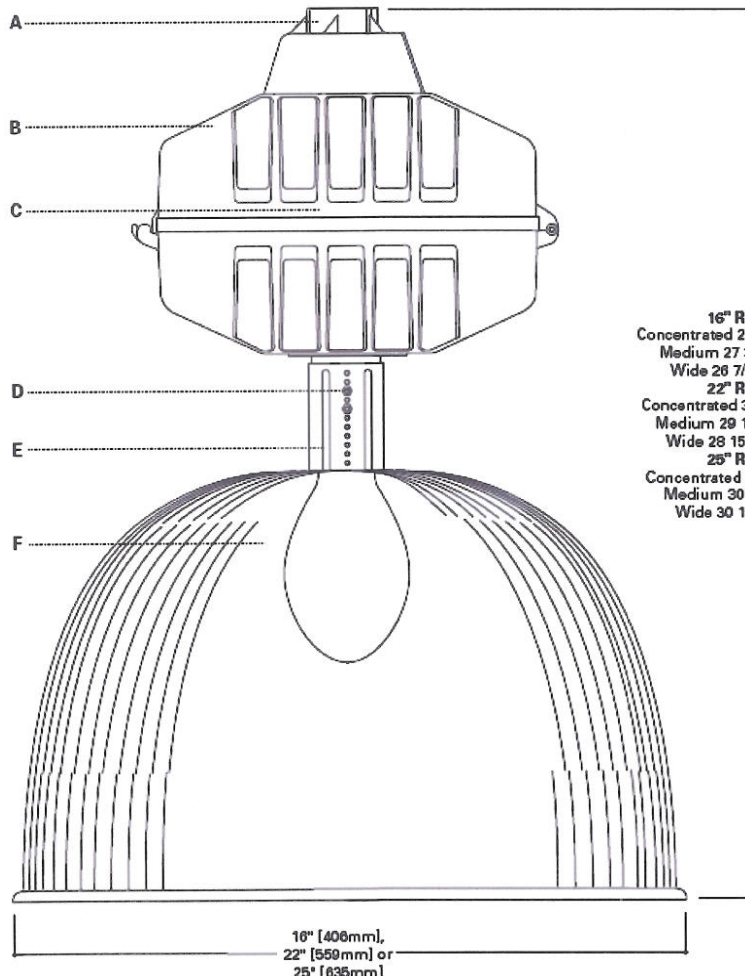

16" Reflector
Concentrated 27 15/16" [710mm]
Medium 27 3/16" [691mm]
Wide 26 7/16" [671mm]
22" Reflector
Concentrated 30 7/16" [773mm]
Medium 29 11/16" [754mm]
Wide 28 15/16" [735mm]
25" Reflector
Concentrated 31 5/8" [803mm]
Medium 30 7/8" [784mm]
Wide 30 1/8" [765mm]

16" [400mm],
22" [559mm] or
25" [635mm]

Powered by
ECON
technology

TECHNICAL DATA

40°C Ambient Environment
(ECON™ Electronic Pulse Start MH)
105°C Supply Wire Rating

ENERGY DATA

CWA Ballast Input Watts
175W MH HPF (210 Watts)
250W MH HPF (295 Watts)
250W HPS HPF (300 Watts)
320W MP HPF (365 Watts)
350W MP HPF (395 Watts)
400W MP HPF (448 Watts)
400W MH HPF (455 Watts)
400W HPS HPF (465 Watts)
600W HPS HPF (665 Watts)
750W HPS HPF (850 Watts)
1000W MH HPF (1080 Watts)
1000W HPS HPF (1100 Watts)

Electronic Ballast Input Watts
250W MD Electronic (275 Watts)
320W MD Electronic (345 Watts)
350W MD Electronic (375 Watts)
400W MD Electronic (425 Watts)

SHIPPING DATA

Approximate Net Weight:
37 lbs. (17 kgs.)



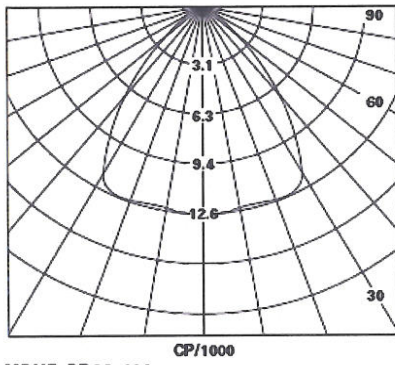

MDHB-PD22-400
400-Watt MH
36,000-Lumen Coated Lamp*
*Coated lamp recommended.

Coefficients Of Utilization

rc	Effective floor cavity reflectance																		
	90%				70%				20%										
rw	70	50	30	10	70	50	30	10	50	30	10	50	30	10	50	30	10		
RCR	1	93	89	85	82	88	85	82	79	78	75	73	71	69	68	65	64	62	59
	2	86	79	74	70	82	76	71	67	70	66	63	64	61	59	59	57	55	52
	3	79	71	65	60	76	69	63	59	63	59	55	59	55	52	54	51	49	46
	4	74	65	59	53	70	62	56	51	58	53	49	54	49	46	50	46	44	41
	5	69	59	52	47	65	57	50	46	53	47	43	49	45	41	46	42	39	37
	6	64	54	47	42	61	52	45	41	48	43	39	45	41	37	42	38	36	34
	7	60	49	42	38	57	48	41	37	45	39	35	42	37	34	39	35	32	30
	8	56	45	39	34	53	44	38	33	41	36	32	39	34	31	36	32	30	28
	9	52	42	35	31	50	40	34	30	38	33	29	36	31	28	34	30	27	25
	10	49	39	32	28	47	38	32	28	35	30	27	33	29	26	32	28	25	23

Candlepower	
Degree	CP
0	12639
5	12639
15	12439
25	12629
35	9833
45	4858
55	1337
65	969
75	1025
85	1122
90	1154
95	1193
105	1175
115	1067
125	964
135	1054
145	1222
155	1101
165	897
175	192
180	129

Spacing Criterion 1.3

Zone	%Lamp	Zone	%Lamp
0-30	29.1	0-90	69.6
0-40	46.0	90-180	19.1
0-60	60.5	Total	88.7

LAMP MORTALITY AND LUMEN MAINTENANCE COMPARISONS

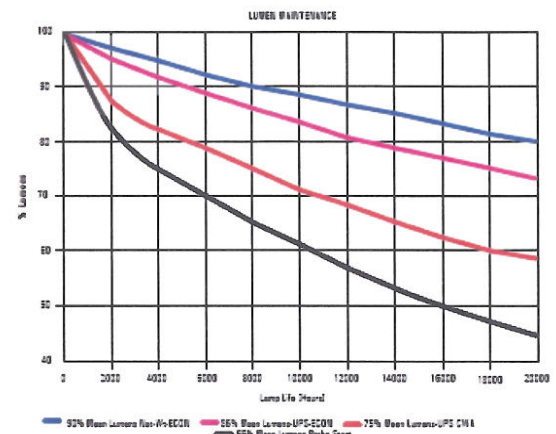
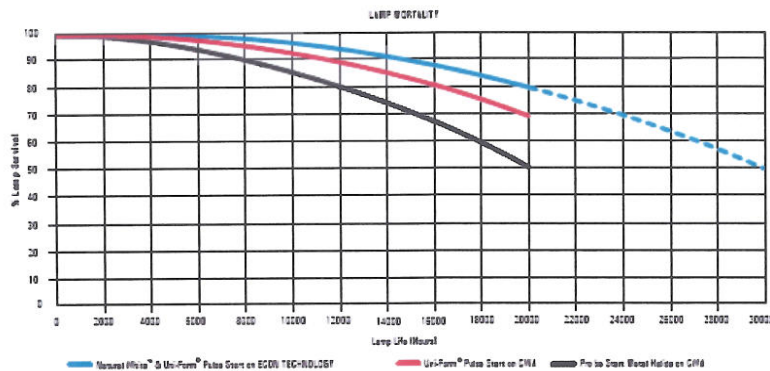

Lamp Mortality and Lumen Maintenance Charts Courtesy of VENTURE*

LAMP ORDERING INFORMATION

SAMPLE NUMBER: EQ320-E-BU-C-MG-E28-C-90-C-U

LAMP TYPE	WATTAGE	LUMINAIRE RATING	BURN POSITION	CLEAR/COATED	BASE TYPE	BULB TYPE	LAMP MANUFACTURER	CRI	LAMP COLOR	FEATURES
EQ = ECON™	250	O = Open	BU = Base Up	C = Clear	MG = Mogul	E28 = ED/BT28*	C = Cooper	90 = 90 > 3, 12	C = Cooper	U = UV Coated
Metal	320	E = Enclosed	Standard	D = Diffused/Coated	E39†	E37 = ED/BT37†	Common	70 = 70-79	Common ‡	Z = No Extra Features
Halide †	350		(+/- 15°)		MR = Mogul Restricted		Cooper	60 = 60-69	35 = 3500-3900K	
	400				EX39 ‡		V = Venture		40 = 4000-4400K	
									50 = 5000-5400K ‡ 14	

VENTURE NATURAL WHITE (TM) ORDERING INFORMATION

SAMPLE NUMBER: EQ320-O-BU-C-MR-E37-V-90-50-Z

LAMP TYPE	WATTAGE	LUMINAIRE RATING	BURN POSITION	CLEAR/COATED	BASE TYPE	BULB TYPE	LAMP MANUFACTURER	CRI	LAMP COLOR	FEATURES
EQ	320	O = Open	BU = Base Up	C = Clear	MR = Mogul Restricted	E37 = ED/BT37	V = Venture	90 = 90 >	50 = 5000-5400K	Z = No Extra Features
	350		Standard	D = Diffused/Coated	EX39					
	400		(+/- 15°)							

NOTES: 1 ECON™ Quartz Metal Halide must be approved lamp supplier. 2 Not available in 80CRI and 5000K CCT. 3 Requires specification of open rated lamp in conjunction with restricted base. 4 Specifying lamp manufacturer selections other than Cooper Common require CRI, Lamp color and feature category to be completed. 5 Only Available in 5000K CCT. 6 Where lamp temperature is specific, enter first two digits of kelvin. 7 Kelvin temperature callout is provided for a general range of correlating temperature. EXAMPLE 40 will range from 4000-4200K CCT. 8 Common is 4K. 9 Only available in 80CRI. 10 Not available on 250W.

ORDERING INFORMATION

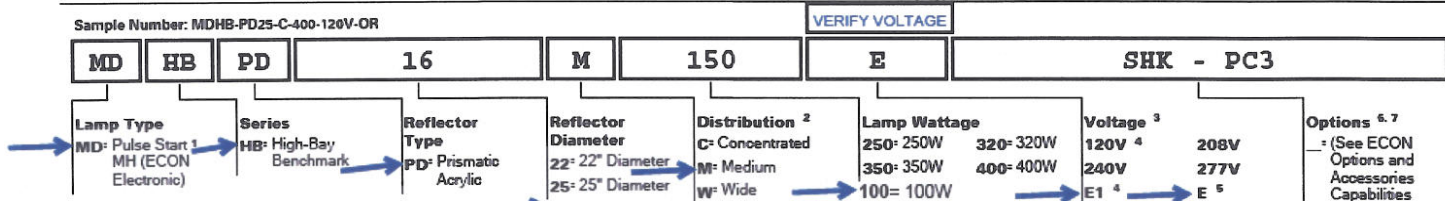

Notes: 1 2005 NEC code requires that open luminaires must utilize a safety glass bottom (ISGB) accessory or an Open rated socket (ORI) and lamp. 2 Factory set for concentrated medium or wide distributions only if P (Factory pre-set) is in the nomenclature of the fixture. 3 MD will operate 50 or 60 Hz. 4 250V only, 120 - 277V 5 250, 320, 350 and 400W only, 200 - 277V. 6 Must be listed in the order shown and separated by a dash. 7 Specify voltage for "Q" and "EM" options

Sample Number: HPMB-PD16-C-250-120V

MD	HB	PD	16	M	100	E	SHK	PC3
----	----	----	----	---	-----	---	-----	-----

- Options ¹⁸**
- VI:** Visual Indicator system, externally mounted LED Signal
 - PS:** Protective Starter (Available in 1000W¹⁴ HPS only. For other wattages consult factory).
 - P:** Pre-set Socket Position from the factory
 - OR:** Open Rated Socket For Metal Halide Lamps
 - SS:** Space Saver Feature
 - QB:** Quiet Ballast
 - Q:** Quartz Restrike DC Bayonet Base (Does not strike at cold start)
 - EM:** Quartz Restrike with "Delay Relay" (Quartz lamp strikes at both hot and cold starts)
 - EM/SC:** Emergency Separate Circuit¹⁶
 - QD:** Quick Disconnect Die-Cast Pendant¹⁶ Mount Box(Specify Single Voltage, Not Compatible with PC3, PHC, C3, MWS, RM or HC)
 - SCF:** 3' Aircraft Safety Cable secures Housing to Ceiling (Alternative lengths available. Example: SCF6 = 6' Cable)
 - SCR:** Aircraft Safety Cable-Housing to Reflector
 - TE:** Toolless Entry
 - LTCB:** Less Top Connector Box (Housing shipped less top connector box. (Specify when using TWMB accessory)
 - RM:** Remote Mount¹⁷
 - LL:** Lamp Included
 - QLL:** Quartz Lamp Included (Lamp is Cooper designated product based on luminaire requirements. Lamp is shipped separate from luminaire unless otherwise noted)
 - WMWS:** MWS Industrial components attached to the fixture at the factory. (Standard cord length is 3 ft, 6 ft, and 11 ft, also available. Please refer to MWS Modular Wiring System section for additional information.
 - F1:** Single Fuse (120, 277 or 347V only)
 - F2:** Double Fuse (208, 240 or 480V only)
 - FH-1:** Die-cast Aluminum Fixture Hook (with 3/4" threads for easy installation)
 - FL-1:** Malleable Iron Plated Fixture Loop (with 3/4" threads for easy installation)
 - SHK:** Die-cast Aluminum Fixture Hook (with safety screw and 3/4" threads for easy installation)
 - C3:** 3' Cord with no plug (Must use with FH-1 or FL-1, or SHK)
 - PC3:** 3' Cord with NEMA Plug (120V-L5-15P, 208V-L6-15P, 347V-L37-20P, AND 480V-L8-20P)Other cord lengths are available by specifying length (PC6 for 6' Cord) Requires FH-1 or FL-1, or SHK. Example: PC3-120VUse with
 - PHC:** Power Cord and Plug (18" Power Cord and Non-NEMA plug configuration. Must be used with FL-1 and TPPH (Thru-Way Pendant Power Hook). Must specify single voltage.
 - PHC-NEMA:** Power Cord and NEMA Plug (18" Power Cord and and 20 AMP NEMA plug configuration). Must be used with FL-1 and TPPH-NEMA (Thru-Way Pendant Power Hook).
 - HL:** LumaWatt Fixture Control Module ¹⁸ (Allows low voltage control wire to be daisy-chained between fixtures outside AC conduit run similar to low voltage intercom's, fire alarms and phone systems)
 - HSW:** Integral LumaWatt Sensor and ¹⁸ Control w/ Wide Distribution
 - HC:** LumaWatt Fixture Control Module ^{18, 19} (Low voltage leads pulled out of top connection box for areas requiring all wiring to be installed in conduit)

- Accessories**
- C3:** 3' Cord-No Plug - Requires FH-1, FL-1, or SHK
 - PC3:** 3' Cord with NEMA Plug - (120V-L5, 208V-L6-15P, 347V-L37-20P and 480V-L8-20P) Other cord lengths are available by specifying length (PC6 for 6' cord) Requires FH-1 or FL-1, or SHK. Use with TPPH-NEMA. Specify Voltage.
 - PHC:** Power Hook Cord and Non-NEMA plug configuration. Must be used with FL-1 and TPPH (Thru-Way Pendant Power Hook)
 - PHC-NEMA:** Power Cord and NEMA plug - 18" Power Cord and 20 Amp NEMA plug configuration. Must be used with FL-1 and TPPH-NEMA (Thru-Way Pendant Power Hook)
 - SGB16:** Safety Glass Bottom for 16" Reflector (not compatible with "WG") (250W maximum)
 - WG16:** Wire Guard
 - WG16/GLC:** Gym Wireguard w/ Safety Glass
 - WG16/SGB:** Gym Wire Guard with Safety Glass Bottom for 16" Reflector
 - FWG16/WG16:** Full Wire Guard for PD16 (SGB not included)
 - FWG16/WG16/SGB16:** Full Wire Guard for 16" Reflector and SGB 16 Lens
 - WGD16:** Wire Guard for DB16
 - SGB22:** Safety Glass Bottom for 22" Reflector (Not Compatible with WG22 - 400W max.)
 - FWG22/WG22:** Full Wire Guard for 22" Reflector
 - FWG22/WDB:** Wire Guard with DB22 Drop Lens for PD 22" Reflector - DB22 not included
 - WG22:** Wire Guard for PD 22" Reflector(Not compatible with SGB)
 - FWG22/WG22/SGB22:** Full Wire Guard for 22" Reflector and SGB22 lens (400W Max.)
 - SGB25:** Safety Glass Bottom for PD 25" Reflector (Not Compatible with WG25)
 - WG25:** Wire Guard (Not Compatible with "SGB")
 - WG25/SGB:** Gym Wire Guard with Safety Glass Bottom for PD 25" Reflector (400W Max)
 - WGD25:** Wire Guard for DB25
 - FWG25/WDB:** Wire Guard with DB25 Drop Lens for PD 25" Reflector
 - FWG25/WG25/SGB25:** Full Wire Guard with "SGB" (400W Max.)
 - FWG25/WG25:** Full Wire Guard for PD25 (SGB not included)
 - DB16:** 16" Drop Lens (250W max.)
 - DB22:** Drop Acrylic Reflector for 22" (400W max.)
 - DB25:** 25" Drop Lens
 - CB22:** Conical Bottom for 22" Reflector (Maximum 400W).
 - CB16:** Conical Bottom Lens for 16" Reflector
 - MBT:** Twin Mount Bracket (Fixtures must be same voltage and without hooks, loops or plugs.)
 - TPPH:** Thru-Way Pendant Power Hook. Requires FL-1 and PHC. Specify Voltage.
 - TPPH-F:** Thru-Way Pendant Power Hook Single Fuse, 120, 277 or 347 Volt. Requires FL-1 and PHC. Specify Voltage.
 - TPPH-F2:** Thru-Way Pendant Power Hook - Double Fused, 208, 240, or 480 Volt. Requires FL-1 and PHC. Specify Voltage.
 - TPPH-F-OD:** Thru-Way Pendant Power Hook Single Fuse, Quick Disconnect. Requires FL-1 and PHC. Specify Voltage (120, 277, or 347V)
 - TPPH-F2-OD:** Thru-Way Pendant Power Hook Double Fuse, Quick Disconnect. Requires FL-1 and PHC. Specify Voltage (208, 240, or 480V)
 - TPPH-NEMA:** Thru-Way Pendant Power Hook. Requires FL-1 and PHC-XXXV-NEMA. Specify
 - FH-1:** Fixture Hook
 - FL-1:** Fixture Loop
 - SHK:** Hook with Safety Screw
 - TW:** Thru-Way Mounting Box²⁰

OPTALUM 19



Paul Mitchell, The School

INCANDESCENT

1-75W

Pendant luminaire

GLASS DIFFUSER

Faceted pressed soda lime glass diffuser 3/8" thick, 7.5" diameter. The diffuser is available in five finishes to match any interior space: Transparent, Satin, Yellow, Blue or Metallic Gray. The color of the glass is achieved by painting a translucent acrylic coating on the inside to enhance its luminous glow. The paint is then thermally cured for superior adhesion. The Blue version has an additional layer of white paint to increase light diffusion. The metallic gray version is opaque. The glass is held in place by a chrome plated die cast aluminum retainer ring that is secured to the housing with three screws and lockwashers. Diffusers are ordered separately from the rest of the luminaire

JUNCTION BOX MOUNTING PLATE

Die Cast aluminum mounts to junction box and includes a stainless steel wire cable tether to facilitate mounting and final wiring.

HOUSING

Extruded aluminum, chrome plated finish, available upon

request.

LENS HOLDER

Die-cast, chrome finish, suspended by (3) stainless steel aircraft cable wire, 75" long. Final leveling adjustment can be made to the luminaire after installation. Modification to shorten the cables can be done in the field. For longer lengths consult factory.

CANOPY

Die cast aluminum, chrome plated finish.

ELECTRICAL

Medium base porcelain socket with nickel-plated screw shell, 250V, 250W rated.

LAMPS

75W A lamp, medium base. Lamp supplied by others.

WIRING

UL listed #18-3 supply cord, 75" long. For longer cables consult factory

LISTINGS

UL and cUL Listed for Damp Locations

Canopy and lens holder with or without housing to be ordered separately from diffuser.



1-75W



073726 / 2780

PRODUCT CODE

Paul Mitchell, The School

PROJECT

K

TYPE

LUMINAIRE	LAMP	VOLTAGE	FINISH
073725	1-75 W E26 Med	120	Chrome
073726	1-75 W E26 Med	120	Chrome w/o extrusion

DIFFUSER		FINISH
2780	19 Glass	Transparent
2781	19 Glass	Mat
2782	19 Glass	Blue
2783	19 Glass	Yellow
2784	19 Glass	Metallic Gray

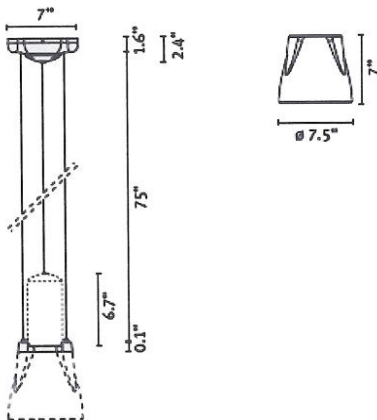

VERIFY DIFUSER FINISH TRANSPARENT OR MAT

Prisma North America, Inc.
 300 Petty Road, Suite C - Lawrenceville, GA 30043
 Voice 770.822.2115 - Fax 770.822.9925
 Email: info@prismalighting.com



OPTALUM 19



PRISMATECH

INCANDESCENT

1-75W

1-75W

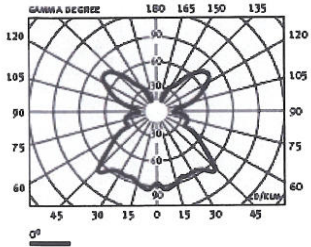

1-75W

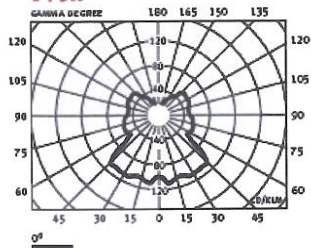

1-75W

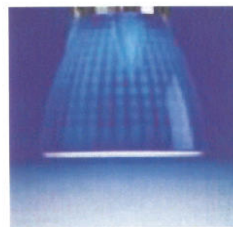
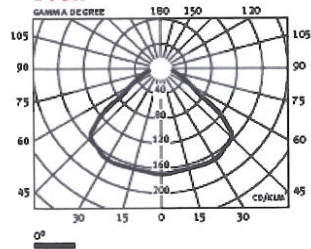

1-75W

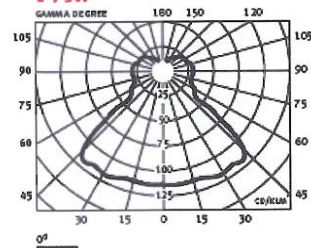

1-75W

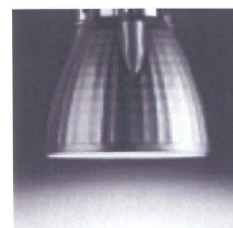
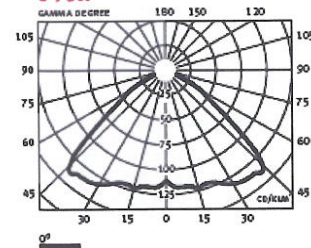

COOPER LIGHTING - SURE-LITES®

DESCRIPTION

The CC Series Contractor's Choice Emergency Lighting Unit is the ideal choice when a simple installation and a reasonable cost are required. Its contemporary round corner styling, designer white finish, and consistent family appearance enables it to blend with any decor. The components are injection molded from tough polycarbonate materials which resist discoloration due to age and ultraviolet radiation.

Catalog #	CC5WH215	Type	EM
Project	Paul Mitchell, The School	Date	
Comments			
Prepared by	Wiedenbach-Brown		

SPECIFICATION FEATURES

Electronic

- Dual Voltage Input 120/277 VAC, 60Hz
- Line-latching
- Solid-state Voltage Limited Charger
- Solid-state Switching
- Brownout Circuit
- Low-Voltage Disconnect
- Overload/Short Circuit Protection
- Test Switch/Power Indicator Light
- Push-in AC power connectors facilitate installation

Housing Construction

- All components are injection molded, color stable, high impact UL 94-5VA rated polycarbonate material
- Designer white textured finish standard; black finish optional
- Components are of snap-fit construction to facilitate under 2-minute installation
- Reinforcing ribs throughout to provide maximum strength

- Tether straps between housing and mounting plate facilitate installation
- Cutouts provided in housing for surface conduit attachment
- Suitable for wall or ceiling mount applications
- Universal J-box mounting pattern
- Keyhole mounting slots

Battery

- Sealed Lead Calcium, recombination
- Nickel Cadmium Battery (CC3NC)
- Maintenance-free, long-life
- Full recharge time: 24 hrs. (max.)
- Polarized battery terminals

Code Compliance

- UL 924 Listed
- UL Damp Location Listed (CC5.SD only)

- Life Safety NFPA 101
- CSA Certified
- NEC/OSHA
- Most State and Local Codes

Warranty

- Exit: 1-year
- Lead Acid Battery: 5-year pro-rata
- Nickel Cadmium Battery: 15-year pro-rata

Head/Lamp Data

- Two heads standard
- PAR 36 type heads
- Glare-free lens
- Fully adjustable lamp housing
- High impact polycarbonate
- Matches housing finish
- Optional square and MR16 heads available

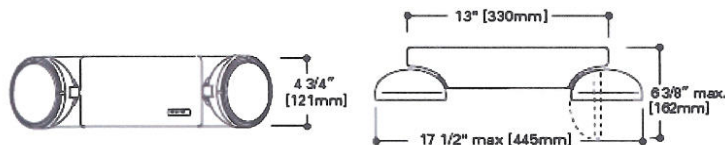

ELECTRICAL RATINGS

Model	Rated Wattage to 87 1/2% of Rated D.C. Voltage				Lamp Information				
	DC Voltage	1 1/2 Hours	2 Hours	3 Hours	4 Hours	Type	Wattage	Number	Spacing ²
CC3	6	10.8	7.2	-	-	Incandescent	5.4	29-121	18.5'
CC3NC ¹	6	16	-	-	-	Incandescent	5.4	29-121	18.5'
CC3	6	10.8	-	-	-	MR16	5	29-139	18.0'
CC4	6	18	15	10	8	Incandescent	9	29-84	22.0'
CC4	6	18	15	10	8	MR16	9	29-145	35.0'
CC4NC ¹	6	18	-	-	-	Incandescent	9	029-84	22.0'
CC5	6	27	24	18	14	Incandescent	9	29-84	22.0'
CC5	6	27	24	18	14	MR16	9	29-145	35.0'
CC5NC ¹	6	24	-	-	-	Incandescent	9	029-84	22.0'
CC6	6	32	-	-	-	Incandescent	9	29-84	22.0'
CC6	6	32	-	-	-	MR16	9	29-145	35.0'

ORDERING INFORMATION

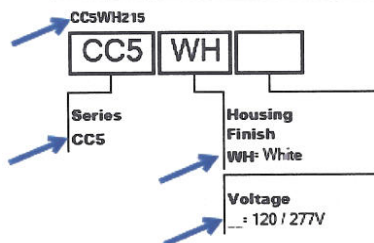

Notes: 1 Add as a suffix. 2 Consult your Cooper Lighting Representative for alternate lamps and additional options. 3 Order separately.

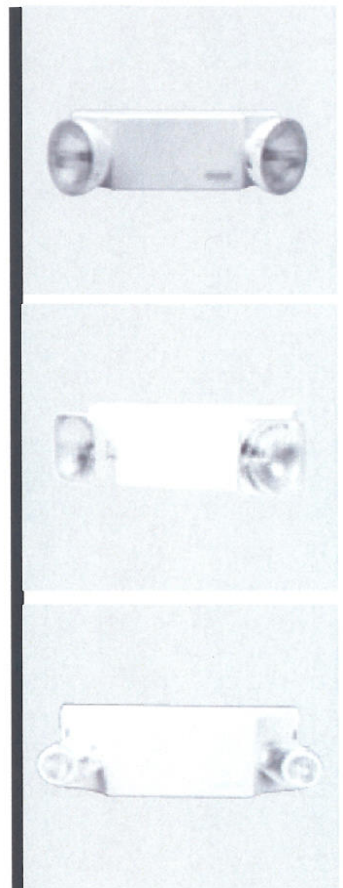

**CC
SERIES**

**SEALED LEAD
CALCIUM BATTERY,
NICKEL CADMIUM BATTERY
Emergency Lighting**

**TOTALLY PREDICTABLE
RELIABILITY**

ENERGY DATA

Model CC3	Model CC5
Input Current (Max.): 120V = .12A	Input Current (Max.): 120V = .13A
277V = .05A	277V = .06A
347V = .01A	347V = .06A
Model CC4	Model CC6
Input Current (Max.): 120V = .12A	Input Current (Max.): 120V = .13A
277V = .05A	277V = .06A
347V = .01A	347V = .06A

PHOTOMETRICS

TECHNICAL DATA

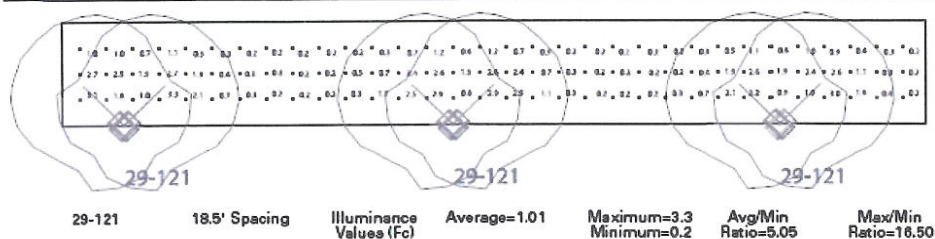

For Standard Fixture: CC3, CC3NC

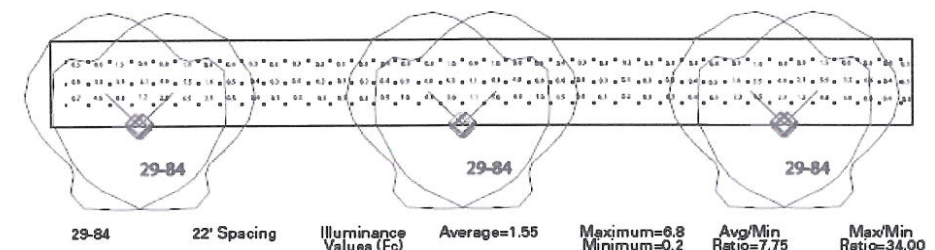

For Standard Fixture: CC4, CC5, CC6

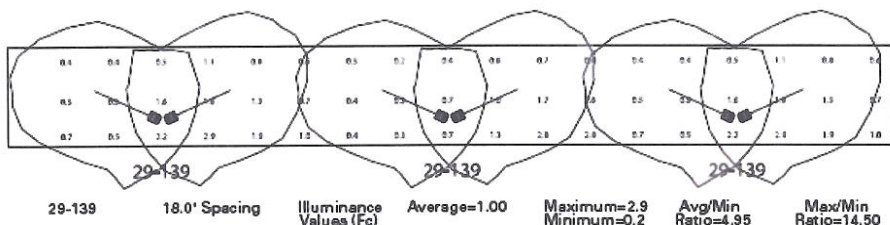

For Standard Fixture: CC3MRT

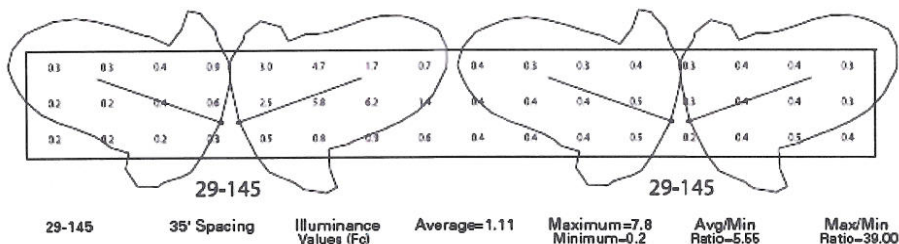

For Standard Fixture: CC4MRT, CC5MRT, CC6MRT

NOTE

The "Rule of Thumb" spacing guidelines are designed to achieve 1 foot-candle average and 0.1 foot-candle minimum with a 40:1 maximum/minimum ratio. The corridor used is 100 feet long, 9 foot ceiling with a 6 foot wide walkway and 3 foot path of egress. The reflectances are 80% ceiling, 50% walls and 20% floors. The fixture mounting height is 7.5 feet with a lamp head angle of 45 degrees. Cooper Lighting assumes no responsibility for local requirements or specific project variables. This is a guideline to be used as a design aid, not as guarantee of any code compliance.

TECHNICAL DATA

Lamps

Designed specifically for emergency lighting applications, the PAR 36 type design insures optimum glare-free trapezoidal light distribution along with horizontal and vertical adjustment by rotating the lens within the housing.

Housing Construction

Rugged, durable, injection molded polycarbonate materials are used throughout the CC Series Emergency Lighting Units. All structural components are designed with reinforcing ribs to add additional rigidity and to maximize structural integrity. These materials are impact and scratch resistant,

and they have been UV stabilized to resist discoloration due to age and ultraviolet radiation. All components are designed to be of snap-fit construction - no mechanical fasteners - to facilitate installation in under 2-minutes. The housing contains hidden tearouts for surface conduit attachment. The housing is tethered to the mounting plate freeing both hands to make electrical connections. The mounting plate has keyhole mounting slots and a universal mounting pattern for quick, efficient installation.

Any components required for installation (wirenuts, wire leads, etc.) are all included with each unit. All CC Series Units are suitable for wall or ceiling mount applications.

Line-Latched

Sure-Lites' line-latched electronic circuitry makes installation easy and economical. A labor efficient AC-activated load switch prevents the lamps from turning on during installation to a non-energized AC circuit. Line-latching eliminates the need for a contractor's return to a job site to connect the batteries when the building's main power is permanently turned on.

Solid-State Charger

Supplied with a 120/277 VAC, voltage regulated solid-state charger. Immediately upon restoration of AC current after a power failure, the charger provides a high charge rate. The charge circuit reacts to the condition of the battery and alters the rate of charge in order to maintain peak battery capacity and maximize battery life. Solid-state construction recharges the battery following a power failure in accordance with UL 924.

Overload and Short Circuit Protection

The solid-state overload monitoring device in the DC circuit disconnects the lamp load from the battery should excessive wattage demands be made and automatically resets when the overload or short circuit is removed. This overload current protective feature eliminates the need for fuses or circuit breakers for the DC load.

Brownout Circuit

The brownout circuit in Sure-Lites units monitors the flow of AC current to the unit and activates the emergency lighting system when a predetermined reduction of AC power occurs. This dip in voltage will cause most ballasted fixtures to extinguish causing loss of normal lighting even though a total power failure has not occurred.

Solid-State Transfer

The unit incorporates a solid-state switching transistor which eliminates corroded and pitted contacts or mechanical failures associated with relays. The switching circuit is designed to detect a loss of AC voltage and automatically energizes the lamps. Upon restoration of the AC power, the emergency lamps will switch off and the charger will automatically recharge the battery.

Low-Voltage Disconnect

When the battery's terminal voltage falls below 80% of the rated voltage, the low-voltage circuitry disconnects the lighting load. The disconnect remains in effect until normal utility power is restored, preventing deep battery discharge.

Test Switch/Power Indicator Light

A test switch permits the activation of the emergency circuit for a complete operational system check. The Power Indicator Light provides assurance that the AC power is on.

Sealed Lead Calcium Battery

The fully sealed, long-life, maintenance-free lead calcium battery is ideal for emergency lighting applications. These recombinant cycle batteries typically provide 8 to 10 years of life and may be operated in any position.

Warranty

All Sure-Lites units are backed by a firm one-year warranty against defect in material and workmanship (excluding lamps). Maintenance-free, long-life, sealed lead calcium batteries carry a five-year pro-rata warranty.

BEST
LIGHTING PRODUCTS

Emergency
Lighting

Emergency
Ballasts

Exit Signs

Accessories

Exit Signs

Click A Model

New York
Approved Exit
Signs

Incandescent
Exit Signs

Combo Incandescent
Exit Sign /
Emergency Unit

LED Exit Sign
Model EZXTE

Combo LED Exit
Emergency Light

LED Remote
Capable Models

Combo Jr. LED
Exit Sign

Edge Lit LED
w/ Recessed Mount

Edge Lit LED
Exit Signs

Cast Aluminum
LED Exit Sign

Self-Luminous
Exit Signs

Wet Location
LED Exit Sign

6" Steel LED
Exit Signs

Model EZXTE LED Exit Sign



Slim and low profile LED exit sign provides a crisp, clean look and excellent energy savings.



- [Features](#)
- [Dimensions](#)
- [Ordering Information](#)

Option
Coming
Soon!

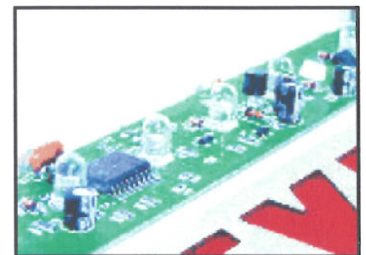

Optional Self Diagnostic/
Self Test feature offers
the ultimate in worry free
maintenance and reliability.

[Learn more.](#)

Features

TYPE EXIT - CATALOG #: EZXTE-U-2-R-W-EM

EXIT

- Completely self-contained.
- Fully Automatic Operation.
- Compact, low profile design in a neutral finish.
- Push to test switch.
- Automatic, low voltage disconnect (LVD).
- 120 or 277 VAC operation.
- Injection-molded, V-O flame retardant, high impact, thermoplastic housing.
- Charge rate/power on LED indicator light.
- Energy consumption of 3.2 watts for red letters and 3.8 watts for green letters.
- LED lamp life of 25 years plus.
- Listed for damp location.

- Universal mounting canopy for top or side installation.
- Standard AC and emergency units available.
- Ni-cad battery on emergency (EM) units.

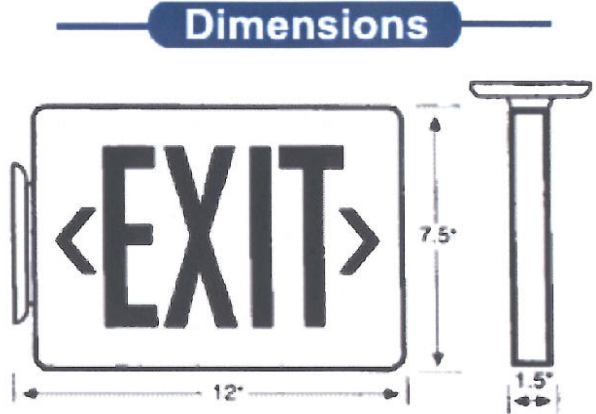

Ordering Information



Series	Canopy	Number of Faces	Letter Color	Housing Color	Battery Backup	Damp Location	Models available for Quick Ship Program:
EZXTE	U - Universal mounting canopy included	1 - Single Face 2 - Double Face	R - Red G - Green	W - White B - Black	EM - Battery Backup Blank - AC Only	Yes	Model # EZXTEU2RW Model # EZXTEU2GW (AC Only) Model # EZXTEU2RW-EM Model # EZXTEU2GW-EM (Battery Backup)
Remote Capable Units - Click Here							



Exit Signs

Models EZXTE-RC and CXTE-RC Remote Capable LED Combo & Remote Capable LED Exit Sign

- Click A Model**
- [New York Approved Exit Signs](#)
 - [Incandescent Exit Signs](#)
 - [Combo Incandescent Exit Sign / Emergency Unit](#)
 - [LED Exit Sign Model EZXTE](#)
 - [Combo LED Exit Emergency Light](#)
 - [LED Remote Capable Models](#)
 - [Combo Jr. LED Exit Sign](#)
 - [Edge Lit LED w/ Recessed Mount](#)
 - [Edge Lit LED Exit Signs](#)
 - [Cast Aluminum LED Exit Sign](#)
 - [Self-Luminous Exit Signs](#)
 - [Wet Location LED Exit Sign](#)
 - [6" Steel LED Exit Signs](#)



- [Features](#)
- [Dimensions](#)
- [Ordering Information](#)

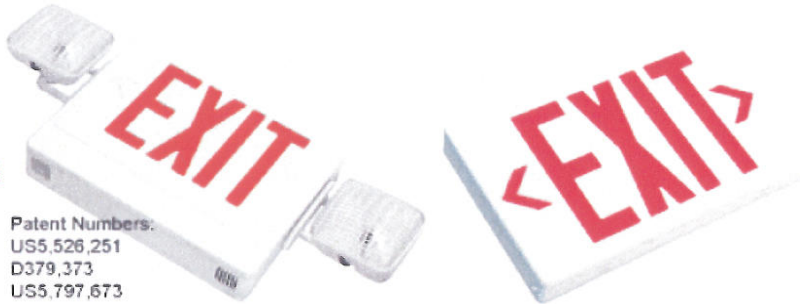

Patent Numbers:
US5,526,251
D379,373
US5,797,673

Combination LED energy saving exit sign and emergency lighting unit in one compact, modern design.

Features

- Universal 120/277 VAC operation.
- Damp location rated.
- Universal canopy included.
- Universal canopy included.
- Universal K/O chevrons.
- Larger Battery for Remote Capacity..

TYPE X2 CAT.#: EZXTEU2RWEM-RC

X2

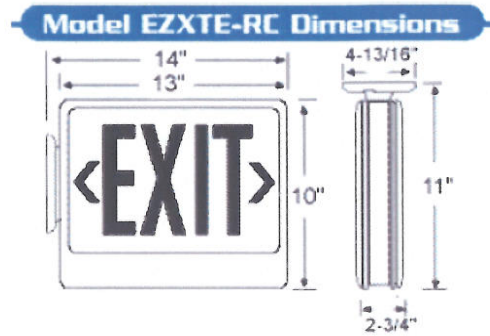
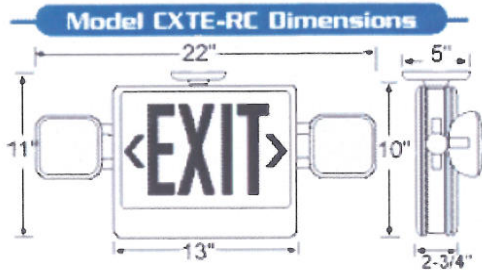

Ordering Information

Remote Capability Combo Ordering Information (Example Catalog # CXTEU1RW-RC)					
Series	Canopy	Number of Faces	Letter Color	Housing Color	Remote Capable
CXTE	U - Universal mounting canopy included	1 - Single Face 2 - Double Face	R - Red G - Green	W - White B - Black	RC

Remote Capability LED Exit Ordering Information (Example Catalog # EZXTEU2GWEM-RC)					
Series	Canopy	Number of Faces	Letter Color	Housing Color	Remote Capable
EZXTE	U - Universal mounting canopy included	1 - Single Face 2 - Double Face	R - Red G - Green	W - White B - Black	EM-RC

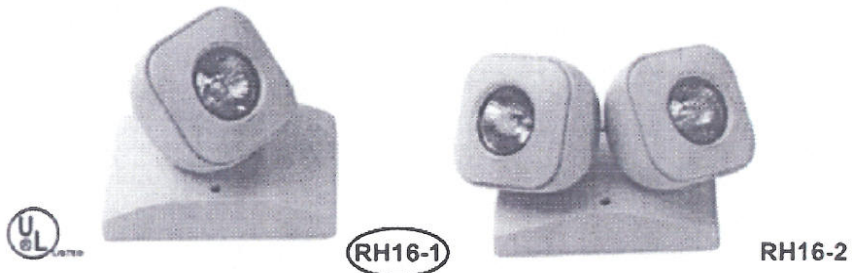

Remote heads are available in either 6 Volt or 12 Volt configurations and several wattage options. Outdoor weatherproof remote heads (WP) are also available. Order the correct voltage and wattage combination to fit your application.

Catalog Number	No. of Heads	Voltage	Wattage
RH16-1	1	6 Volts	5
RH16-2	2	6 Volts	5

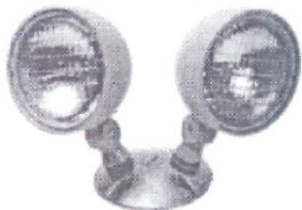
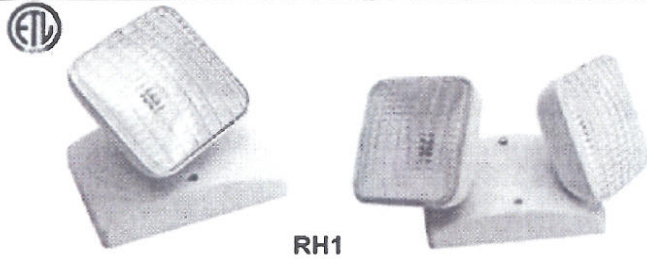

RH2-WP
(Outdoor Weatherproof)



RH1-WP
(Outdoor Weatherproof)

Catalog Number	No. of Heads	Voltage	Wattage
RH1-6V5	1	6 Volts	5
RH1-6V9	1	6 Volts	9
RH2-6V5	2	6 Volts	5
RH2-6V9	2	6 Volts	9
RH1-12V7	1	12 Volts	7.2
RH1-12V12	1	12 Volts	12
RH2-12V7	2	12 Volts	7.2
RH2-12V12	2	12 Volts	12
RH1-WP6V7	1	6 Volts	7.2
RH2-WP6V7	2	6 Volts	7.2



Building Automation, Inc.

Networked Lighting Control Systems

INNOVATIVE, INTEGRATED and SIMPLE.

Ceiling and Wall Mount Occupancy Sensors

OMNI™ Dual Technology Ultrasonic and Passive Infrared Ceiling Sensor featuring IntellADAPT™

KEY FEATURES

- IntellADAPT Technology - Continuous self-adapting sensor
- All-Digital, multi-technology (Ultrasonic & PIR) sensor
- Non-volatile memory for sensor settings
- 500 to 2000 sq. ft. coverage
- Optional relay and photocell control
- Optional Quick To Install (QTI) connector
- UL and cUL listed
- Five-year warranty



OMNIDT2000

OVERVIEW

The OMNI Dual Technology ceiling mount occupancy sensor combines both ultrasonic (US) and passive infrared (PIR) sensing technologies to turn lighting systems on and off based on occupancy. The combination of these two technologies proves crisp turn-ons and virtually eliminates turn-offs. The OMNI Dual Technology sensor features Hubbell Building Automation's patented IntellADAPT™ technology which continuously analyzes the environment and self-adapts to meet those specific challenges. This exclusive technology eliminates manual sensitivity and timer adjustments during installation and over the life of the product – providing true maintenance free "Install and Forget" operation.

FEATURES and BENEFITS

Features	Benefits
IntellADAPT™	<ul style="list-style-type: none"> • Sensor automatically determines optimum setting to properly cover the area. • Excellent false tripping immunity • No manual sensitivity and timer adjustments – providing maintenance free "Install and Forget" operation.
All-Digital, multi-technology (Ultrasonic and PIR) sensor	<ul style="list-style-type: none"> • Superior ultrasonic minor motion detection with excellent PIR long-range major motion detection
Non-volatile memory for sensor settings	<ul style="list-style-type: none"> • Learned and adjusted settings will not be lost during power outages
Optional relay and photocell control	<ul style="list-style-type: none"> • Easy integration with Building Automation Systems • Increases energy savings by preventing the lights from turning on when there is sufficient natural light.
Optional Quick To Install (QTI) connector	<ul style="list-style-type: none"> • Dramatically reduces installation costs by removing the time consuming process of manually wiring sensor to power pack • Easy to install, fast and efficient – no cutting, stripping, or wire nuts required to install

APPLICATIONS

- Offices
- Small conference rooms
- Break rooms

SPECIFICATIONS

IntellADAPT™	<ul style="list-style-type: none"> • Auto reset from test setting • Self-adjusting timer • Self-adjusting ultrasonic and passive infrared thresholds • Automatic false-on, false-off corrections
LED Lamp	• Red – Infrared motion, Green – Ultrasonic motion
Timer Timeout	<ul style="list-style-type: none"> • Automatic mode: 8 min. to 32 min. (Self adjusts based on occupancy) • Test mode: 8 seconds – for easy check at installation
Ultrasonic output	<ul style="list-style-type: none"> • OMNIDT500: 40kHz output • OMNIDT1000 & OMNIDT2000: 32kHz
Passive Infrared	• Dual element pyrometer and 12 element cylindrical rugged lens
RP Option	<ul style="list-style-type: none"> • Relay and Photocell Included (both) • Relay: NO + NC contacts, SPDT, 500 mA rated @ 24VDC, three wire, isolated relay • Photocell: Adjustable ambient light override ranges from 0 foot candles (0 lux) to 100 foot candles (1000 lux)
Coverage	• 500 to 2000 sq. ft. (depending on model)
Power Requirements	• 24 VDC, 33 mA (uses MP-Series power pack – not included)
Output	• 24 VDC active high logic control signal with short circuit protection and optional dry contact (see –RP Option)
Operating environment	<ul style="list-style-type: none"> • Indoor use only • Operating temperature: 32° – 104°F (0° to 40°C) • 0% to 95% relative humidity, non-condensing
Construction	<ul style="list-style-type: none"> • Housing – Rugged, high impact, injection molded plastic KJB ABS Cyclocac (UL-945VA) flame class rating, UV inhibitors • Color-coded leads are 6" long
Size & Weight	<ul style="list-style-type: none"> • Size: 4.5" dia., 1.5" height (114 mm dia., 38mm height) • Weight: 5.0 oz (142g)
Color	• Off White
Mounting	• Mounting base provided with sensor
Certifications	• UL and cUL Listed
Warranty	• 5 years

HOW TO ORDER

Catalog Number	Description	Color	Coverage
OMNIDT500	Ultrasonic and PIR Ceiling Sensor with IntellADAPT	White	500 sq. ft.
OMNIDT500RP	Ultrasonic and PIR Ceiling Sensor with IntellADAPT (Relay and Photocell)	White	500 sq. ft.
OMNIDT1000	Ultrasonic and PIR Ceiling Sensor with IntellADAPT	White	1000 sq. ft.
OMNIDT1000RP	Ultrasonic and PIR Ceiling Sensor with IntellADAPT (Relay and Photocell)	White	1000 sq. ft.
OMNIDT2000	Ultrasonic and PIR Ceiling Sensor with IntellADAPT	White	2000 sq. ft.
OMNIDT2000RP	Ultrasonic and PIR Ceiling Sensor with IntellADAPT (Relay and Photocell)	White	2000 sq. ft.

*Add QTI to end of catalog number for optional Quick To Install connector.

RANGE DIAGRAMS

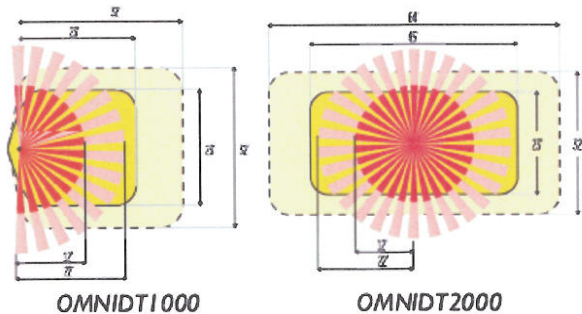

Hubbell Building Automation, Inc.
 9601 Dessau Road | Building One | Suite 100
 Austin, Texas 78754
 {512} 450-1100 | {512} 450-1215 fax
www.hubbell-automation.com



Power Packs and Relays

Universal Voltage Power Pack

KEY FEATURES

- Universal voltage – 100 to 277VAC, 50/60Hz
- Automatic voltage detection
- Capable of switching up to 20 Amps of electrical load
- Regulated 24VDC current, 150mA output, short circuit protected
- Zero Arc Point Switching
- Plenum rated
- Mounts inside or outside junction box, or inside fluorescent ballast cavity
- Available with exclusive QTI (Quick-To-Install) system
- UL and cUL Listed
- 5 year warranty



OVERVIEW

The Universal Voltage Power Pack is a self-contained transformer and relay that is designed to eliminate the guesswork in choosing the correct power pack to use with low voltage 24VDC occupancy sensors. The power pack supports and automatically detects input line voltage from 100-277VAC, eliminating the need for voltage-specific power packs or power packs that require special wiring based on the input voltage. The Universal Voltage Power Pack is capable of switching 20A loads and features Zero Arc Point Switching technology that minimizes relay contact wear associated with high inrush loads. A single power pack can be used to supply power to up to four sensors, and can also be used to supply power to the MPSA auxiliary relay for multiple circuits. The Universal Voltage Power Pack is plenum rated and mounts easily inside or outside a junction box.

FEATURES and BENEFITS

Features

Universal Voltage – 100 to 277VAC, 50/60Hz

Automatic voltage detection

Zero Arc Point Switching

Plenum rated

Optional Quick To Install (QTI) connector

Benefits

• No more guessing which voltage-specific power pack to use for your applications – one power pack for all of your 100-277VAC needs.

• No more “specialized wiring” required which you can easily get wrong with multi-voltage power packs. The Universal Voltage Power Pack is wired the same for all applications and automatically detects the line voltage being used.

• Minimizes relay contact wear associated with high inrush loads.

• Complies with requirements for use in a compartment handling conditioned air (plenum).

• Easy to install, fast and efficient – no cutting, stripping or wire nuts required to install.

• Dramatically reduces installation costs by removing the time consuming process of manually wiring sensor to power pack.

SPECIFICATIONS

Power Requirements	100-277VAC, 50/60Hz
Output	24VDC, 150mA nominal, isolated and regulated
Relay Contact Rating	20A, 120VAC Incandescent 20A, 120 or 277VAC Ballast 1HP, 120 or 277VAC Motor Load
Construction	High impact, UL 94-5V plastic
Plenum Rated	Complies with requirements for use in a compartment handling conditioned air (plenum) Plenum rated for external junction box mounting
Operating environment	Indoor use only Operating temperature: 32°– 104°F (0°– 40°C) 0% to 95% relative humidity, non-condensing
Size	3.69"L x 2.33"W x 1.36"H
Color	Black
Certifications	UL and cUL Listed
Warranty	5 years

How To Order

Catalog Number	Description
UVPP	Universal Voltage Power Pack, 100-277VAC, 50/60Hz

* Add QTI to end of catalog number for optional Quick To Install connector.

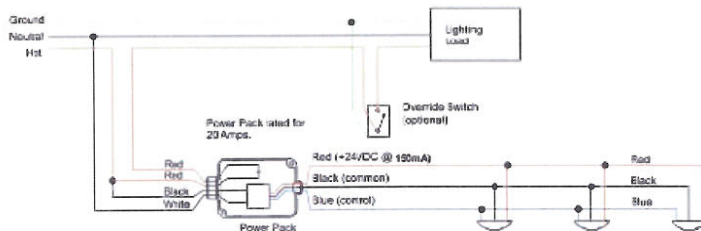

Building Automation, Inc.

Hubbell Building Automation, Inc.
9601 Dessau Road | Building One | Suite 100
Austin, Texas 78754
{512} 450-1100 | {512} 450-1215 fax
www.hubbell-automation.com



Building Automation, Inc.

Networked Lighting Control Systems

INNOVATIVE, INTEGRATED and SIMPLE.

Wall Switch Occupancy Sensors
LightHawk™ Passive Infrared
 Wall Switch Sensor featuring IntelliDAPT™

KEY FEATURES

- All-Digital, Passive Infrared sensor
- IntelliDAPT™ Self Adaptive Technology – No manual adjustment required
- Auto ON or Manual ON operating modes
- 1 000 sq. ft., 180° area of coverage
- Built-in photocell with SuperSaver mode
- RhinoTuff™ lens
- Dual 120/277 VAC operation
- No minimum load requirement
- Zero Arc Point Switching
- ETL listed (UL508 Standard)
- Five-year warranty

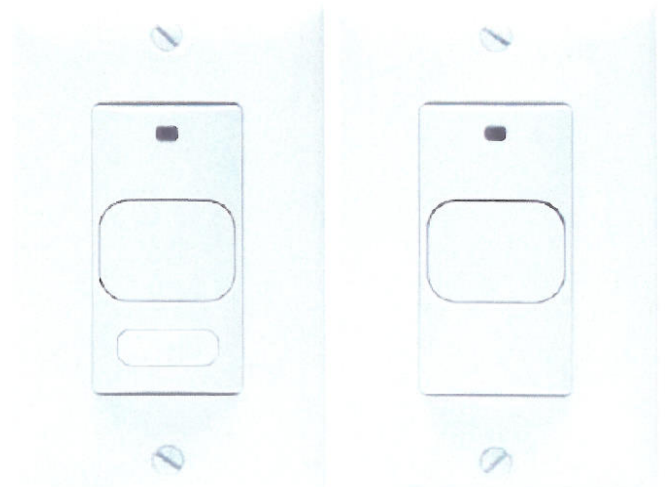

LHIRS1

LHIRS0

OVERVIEW

The LightHawk Passive Infrared wall switch occupancy sensor represents the state-of-the-art in sensor technology by utilizing passive infrared (PIR) technology for unequaled occupancy detection and false trip immunity. The sensor features HBA's patented IntelliDAPT technology that continuously analyzes its environment and self-adapts, eliminating the need for manual sensitivity and timer adjustments during installation as well as over the life of the product. IntelliDAPT provides true maintenance free "Install and Forget" operation. With selectable operating modes - automatic ON/OFF or manual ON/automatic OFF and a built-in photo sensor for automatic daylight harvesting, the LightHawk Passive Infrared wall switch occupancy sensor is simply the most capable wall switch occupancy sensor available in the marketplace today.

FEATURES and BENEFITS

Features	Benefits
IntelliDAPT™	<ul style="list-style-type: none"> • Sensor automatically determines optimum setting.. • No manual sensitivity and timer adjustments required – providing maintenance free "Install and Forget" operation.
All-Digital, Passive Infrared sensor	<ul style="list-style-type: none"> • Excellent passive infrared long-range motion detection
Auto ON or Manual ON operating modes	<ul style="list-style-type: none"> • Provides Auto ON / Auto OFF or Manual ON / Automatic OFF operation
Tamper-proof automatic only version available	<ul style="list-style-type: none"> • Automatically turns lighting loads on and off without requiring user to manually push a button
No minimum load requirement	<ul style="list-style-type: none"> • Allows for connection of loads from 0 to full load capacity
RhinoTuff™ lens	<ul style="list-style-type: none"> • Impact resistant IR lens
Built-in photocell with optional SuperSaver mode	<ul style="list-style-type: none"> • Increases energy savings by preventing the lights from turning on when there is sufficient natural light • Optional SuperSaver mode – in addition to above, turns lights off during periods of occupancy if ambient light levels increase sufficiently to illuminate the area

SPECIFICATIONS

IntelliDAPT™	<ul style="list-style-type: none"> • Self-adjusting timer • Self-adjusting passive infrared sensitivity • Automatic false-on, false-off corrections • No manual adjustments required
Timer Timeout	<ul style="list-style-type: none"> • Automatic mode: 4-30 minutes, self adjusts based on occupancy • Fixed mode: 4, 8, 15 and 30 minutes • Test mode: 5 seconds
Passive Infrared	<ul style="list-style-type: none"> • Dual element pyrometer and 12 element cylindrical RhinoTuff lens
Photocell	<ul style="list-style-type: none"> • Adjustable ambient light override ranges from 10 foot-candles to 500 foot-candles
Coverage	<ul style="list-style-type: none"> • 1000 sq. ft., 180°
Power Requirements	<ul style="list-style-type: none"> • 120/277VAC, 50/60Hz
Electrical Ratings	<ul style="list-style-type: none"> • 120VAC: 800W Incandescent, 1000W Fluorescent, 1/6 HP • 277VAC: 1800W Fluorescent, 1/6 HP
Load Requirements	<ul style="list-style-type: none"> • No minimum load
Operating Environment	<ul style="list-style-type: none"> • Indoor use only • Operating temperature: 32° – 104°F (0° – 40°C) • 0% to 95% relative humidity, non-condensing
Construction	<ul style="list-style-type: none"> • Housing – high impact, injection-molded plastic (UL-94-5V) • Impact resistant lens • Color-coded leads are 6" long
Size & Weight	<ul style="list-style-type: none"> • Size: 4.2" x 1.8" x 2.1", extends out .37" • Weight: 2.9 oz
Color	<ul style="list-style-type: none"> • White, Ivory, Light Almond, Gray, Black
Mounting	<ul style="list-style-type: none"> • Single gang NEMA style switch box (Decorator style wall plate not included)
Certifications	<ul style="list-style-type: none"> • ETL Listed (Conforms to UL STD 508 Certified to CAN/CSA STD C22.2 NO. 14)
Warranty	<ul style="list-style-type: none"> • 5 years

HOW TO ORDER

Catalog Number	Description
LHIRS1*	Passive Infrared Wall Switch Sensor with IntelliDAPT and Automatic/Manual Control, 120/277VAC
LHIRS0*	Passive Infrared Wall Switch Sensor with IntelliDAPT and Automatic Only Control, 120/277VAC

* = W – White, I – Ivory, A – Light Almond, G – Gray, B – Black

RANGE DIAGRAM

*Refer to Application Guide.

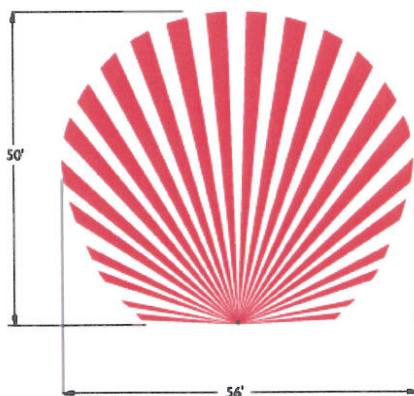

WIRING DIAGRAM

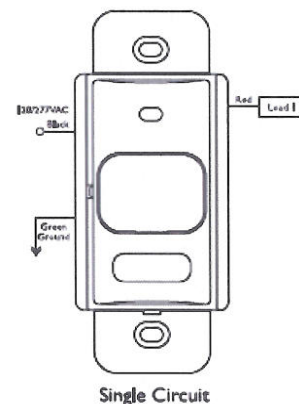

Hubbell Building Automation, Inc.
 9601 Dessau Road | Building One | Suite 100
 Austin, Texas 78754
 (512) 450-1100 | (512) 450-1215 fax
www.hubbell-automation.com

The classic thin-profile linear-slide dimmer.

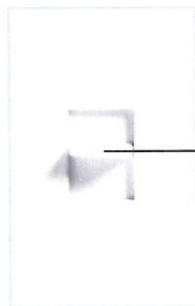

Select light level with slider; slide down to off

Slide-to-off Dimmer



Select light level with slider; press on/off

Preset Dimmer

PRODUCT FAMILY FEATURES

- Classic linear-slide dimmer with thin profile design
- Excellent for residential or commercial applications
- Intuitive operation—easy to use
- Slide-to-off and preset models available
- Enclosed heat sink for aesthetically pleasing appearance
- Multigang alignment for quick and easy installation
- Full family of products for most lighting sources, plus matching accessories and wallplates
- Now available for 277V Magnetic Low Voltage in 600VA and 1000VA ratings
- Metal, custom multi-gang and engraved wallplates available

DIMENSIONS

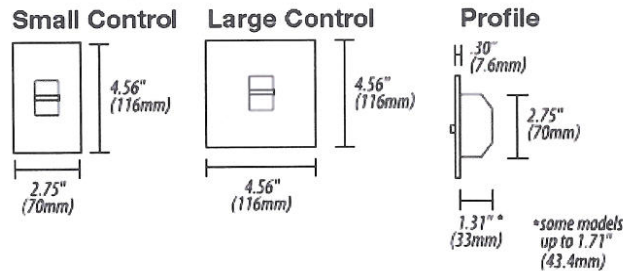

SPECIFICATION SERIES STANDARD FEATURES

UL SP NOM

- Square Law Dimming
- Power-failure memory
- Captive linear slider
- Electrostatic discharge tested
- Heavy-duty components for surge protection and long product life
- Voltage compensation
- Superior RFI suppression
- Accessible air-gap switch
- Precise color matching

Lutron controls are rated at 120VAC, 60Hz unless otherwise noted.

JOB NAME	AREA CONTROLLED
LOCATION	JOB NUMBER
TITLE	PAGE NO.

CONTROLS AND ACCESSORIES

Slide-to-Off Dimmers

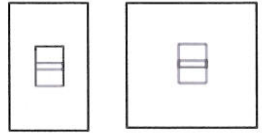

(Small Control) (Large Control)

Preset Dimmers

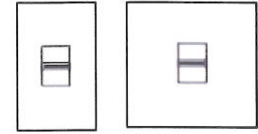

(Small Control) (Large Control)

Omnislide Dimmers



Two Location Dimming System

Linear-Slide Switches

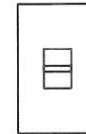

Switch

Slide-to-Off Fan-Speed Controls

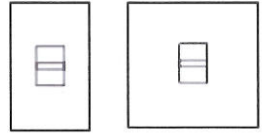

(Small Control) (Large Control)

Receptacles/Plugs

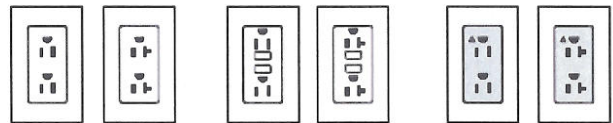

15A 20A Receptacles 15A 20A GFCI Receptacles 15A 20A Isolated Ground Receptacles

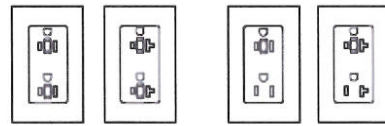

15A 20A Duplex for Dimming Use 15A 20A Half for Dimming Use



10A Replacement Plug for Dimming Use

Telephone/Cable TV Jacks/Ports

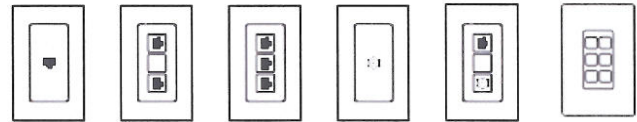

Single Telephone Jack Double Telephone Jack Triple Telephone Jack Cable TV Jack Telephone / Cable TV Jack 6-Port Frame Jack



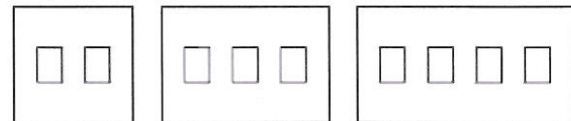



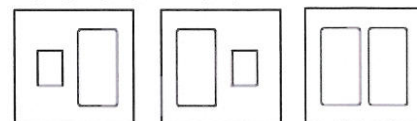



Standard Multigang Wallplates



2-gang, 3-gang and 4-gang for dimmers/switches



2-gang for a dimmer or switch and a receptacle or jack

Description	Maximum Capacity ¹	Model #
DIMMERS		
 Incandescent		
<i>Slide-to-Off Dimmers</i>		
SMALL CONTROL		
 Single pole	600W	NT-600-
 Single pole	1000W	NT-1000-
LARGE CONTROL		
 Single pole	1500W	NT-1500
 Single pole	1950W	NT-2000-
Note: The NT-2000- does not have side sections that are removable and must be ganged with no fins removed.		
<i>Preset Dimmers</i>		
SMALL CONTROL		
 Single pole/3-way	600W	NT-603P-
 Single pole/3-way	1000W	NT-1003P-
LARGE CONTROL		
 Single pole/3-way	1500W	NT-1503P-
Note: For 3-way and 4-way switching use NT-3PS- and NT-4PS- or other mechanical switches.		
<i>Omnislide™ Two-location Dimmers</i>		
 For two-location dimming, use one Base Unit (NTB-600-, NTB-1000-) with one Auxiliary Unit (NTA-2-)		
Base Unit	600W	NTB-600-
Base Unit	1000W	NTB-1000-
Auxiliary Unit (Use with Base Unit) ²		NTA-2-
Electronic Low Voltage		
<i>Slide-to-Off Dimmers⁴</i>		
SMALL CONTROL		
 Single pole	300W ³	NTELV-300-
 Single pole	600W ³	NTELV-600-
Note: Requires neutral wire connection. For electronic low voltage loads up to 1000W, use Nova T [☆] fluorescent dimmers (NTF-10- or NTF-103P-) with an ELVI-1000 interface.		















1 For capacities in multigang installations see derating.

2 No derating required if ganged.

3 Actual lamp wattage.

4 Requires neutral wire connection.

5 To determine the number of ballasts that can be controlled by Nova T[☆] fluorescent dimmer, divide the control capacity by the ballast current. For a complete list of Lutron ballasts and ballast currents, see the Fluorescent Dimming System Selection Guide (366-002).

Description	Maximum Capacity ¹	Model #
DIMMERS		
 Magnetic Low Voltage		
<i>Slide-to-Off Dimmers</i>		
SMALL CONTROL		
 Single pole, 120V	600VA (450W ³)	NTLV-600
 Single pole, 277V ⁴	600VA (450W ³)	NTLV-600-277-
 Single pole, 120V	1000VA (800W ³)	NTLV-1000-
 Single pole, 277V ⁴	1000VA (800W ³)	NTLV-1000-277-
LARGE CONTROL		
 Single pole	1500VA (1200W ³)	NTLV-1500-
<i>Preset Dimmers</i>		
SMALL CONTROL		
 Single pole/3-way	600VA (450W ³)	NTLV-603P-
 Single pole/3-way	1000VA (800W ³)	NTLV-1003P-
LARGE CONTROL		
 Single pole/3-way	1500VA (1200W ³)	NTLV-1503P-
For 3-way and 4-way switching use NT-3PS- and NT-4PS- or other mechanical switches.		
Fluorescent Dimming with Hi-lume[®] and Eco-10[™] (ECO-Series) Electronic Ballasts		
<i>Slide-to-Off Dimmers^{2,5}</i>		
SMALL CONTROL		
 Single pole, 120V	16A	NTF-10-
 Single pole, 277V	8A	NTF-10-277-
Note: Use with Lutron Hi-lume or Eco-10 (ECO-Series) line voltage control Electronic Dimming Ballasts only.		
<i>Preset Dimmers^{2,5}</i>		
SMALL CONTROL		
 Single pole/3-way, 120V	8A	NTF-103P-
 Single pole/3-way, 277V	6A	NTF-103P-277-
Note: Use with Lutron Hi-lume or Eco-10 (ECO-Series) line voltage control Electronic Dimming Ballasts only. For 3-way and 4-way switching use NT-3PS- and NT-4PS- or other mechanical switches.		
Fluorescent Dimming with Eco-10 (TVE-Series) 0-10VDC Electronic Ballasts		
<i>Slide-to-Off Dimmers²</i>		
SMALL CONTROL		
 Single pole, 0-10VDC	60 ballasts/16A	NTFTV-
Use with PP-20.		
Note: Use with Lutron Eco-10 (TVE-Series) 0-10VDC Electronic Dimming Ballasts only. Requires use of an external relay to switch ballast power on/off, Lutron model number PP-20.		
Fluorescent Dimming with Tu-Wire[™] Electronic Ballasts		
<i>Slide-to-Off Dimmers</i>		
SMALL CONTROL		
 Single pole, 120V	5A	NTFTU-5A-
Note: Use with Lutron Tu-Wire line voltage control Electronic Dimming Ballasts only.		

Description

Incandescent Controls NT-Series

These controls are for use with incandescent and quartz lamps only, 120VAC, 60Hz. Do not connect to receptacles, fluorescent fixtures, motor-operated appliances, or transformer-supplied appliances.

Magnetic Low-Voltage Controls NTLV-Series

These controls are for use with low-voltage incandescent and quartz lamps only. Do not connect to receptacles, fluorescent fixtures, or motor-operated appliances. Use with core and coil (magnetic) low-voltage transformers. Do not use to control a solid-state electronic low-voltage transformer. Call the **Lutron Hotline** for more information. Ask for Application Note 19: "Guide to Dimming Low-Voltage Lighting."

Operation of a dimmed low-voltage circuit with all lamps removed or inoperative may result in current flow in excess of normal levels. To avoid possible transformer failure, Lutron strongly recommends the following:

- a. Do not operate dimmed low-voltage circuits without operative lamps in place.
- b. Replace burned-out bulbs immediately.
- c. Use transformers that incorporate thermal protection or fuse transformer primary windings in order to prevent transformer failure caused by excess current.

Electronic Low-Voltage Controls NTELV-Series

These controls must not be used to control magnetic transformer-supplied low-voltage lighting. Use Lutron Magnetic Low-Voltage controls with magnetic transformer-supplied lighting fixtures. Some fixture manufacturers do not recommend dimming their solid-state transformers. To determine if a fixture may be dimmed, consult Lutron or the fixture manufacturer. These controls are overload-protected. If more than the rated wattage is applied, power to the circuit will shut off until the control cools. If this happens, remove excess load from the circuit.

Fan-Speed Controls NTFS-Series

These controls are for use only with fan or blower units that are operated by shaded-pole or permanently-split capacitor motors. Use with other types of motors may damage equipment and void warranty. Use with fans marked "Suitable for use with solid-state fan-speed controls only." Set multi-speed fans to their highest setting before installing controls.

Quiet Fan-Speed Controls NTFSQ-Series

These controls are for use with a single ceiling paddle fan only, rated at 1.5A maximum. (The current rating of your fan motor may be determined from the motor nameplate, packaging, or by contacting the manufacturer.) Do not wire into a circuit with a GFCI breaker or receptacle. Set multi-speed fans to their highest setting before installing controls. Do not use these controls for light fixtures. Not recommended for

use with Hunter Original® Series fan. Contact Lutron's Customer Service department for suitable controls.

Fluorescent Controls NTF-Series

These controls are for use with Lutron's FDB or ECO Series Electronic Fluorescent Dimming Ballasts only. Refer to FDB or ECO Series specification sheets for maximum capacity. Do not use with other ballasts.

Important Notes

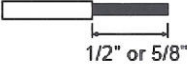
1. Install in accordance with national and local electrical codes.
 2. These controls are designed to operate in ambient temperatures from 0°C to 40°C (32°F to 104°F).
 3. Wire connectors provided are suitable for copper wire only. Use to join one 10, 12, 14, 16, or 18 gauge wire with one or two 12 or 14 gauge wires.
Ces connecteurs conviennent seulement au fil de cuivre.
- 
4. Strip insulation from all wires:
 - 1/2" for 10, 12, and 14 gauge.
 - 5/8" for 16 and 18 gauge.
 5. Check for short circuits in new installations before wiring controls. With power OFF, use appropriate switch and connect to lamp and voltage line. Turn power ON. If breaker trips, a short is present. Correct wiring and check circuit again. Install control only when short is no longer present.
 6. Multiphase applications: Use a separate neutral for each phase containing a control circuit. For more information, call the **Lutron Hotline** and ask for Application Note 17, "Common Neutral Interaction."
 7. To ensure proper dimming performance and full lamp life, fluorescent lamps must be operated at full intensity for 100 hours prior to dimming.

Installation

If more than one control is to be installed in the same wallbox, review the Multigang Installation section (back page) before beginning. Lutron multigang faceplates are available for ganging multiple units.

1. Turn power OFF at fusebox or circuit breaker.
WARNING: Wiring with power on may result in personal injury. Damage to this product caused by wiring with power on voids warranty.
2. Remove faceplate and faceplate adapter from control to prevent damage and to access mounting holes. Pull from top of faceplate to remove. Unscrew faceplate adapter. Set aside.
3. Wire Control per appropriate wiring diagram (see next page) using wire connectors provided.
Note: Color names refer to the wire colors on the control.

Wiring Diagrams

Model Number	Wiring Diagram
NT-600, NT-1000, NT-1500 , NT-2000, NTFTU-5A	1
NT-603P, NT-1003P, NT-1503P	2
Single-Pole	3
3-Way	4
4-Way	4
NTLV-600, NTLV-1000 , NTLV-1500	1
NTLV-603P, NTLV-1003P, NTLV-1503P	2
Single-Pole	3
3-Way	4
4-Way	4
NTELV-300, NTELV-600	7
NTFS-6E, NTFS-12E	5
NTFSQ	1
NTF-10, NTF-10-277	6

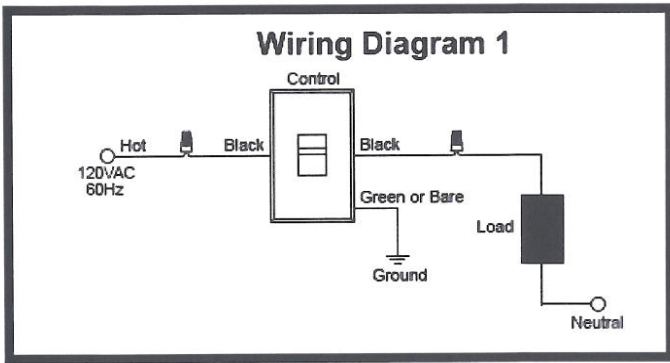

Wiring Diagram 2

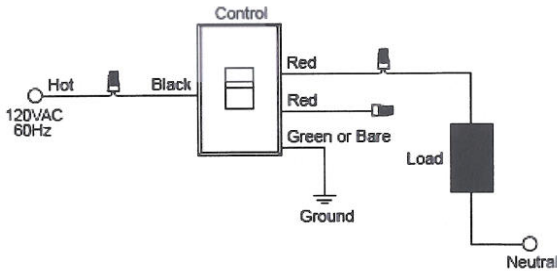

Wiring Diagram 3

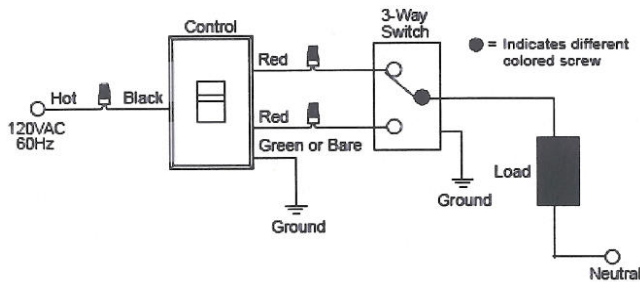

NOTE: Controls may be wired on either the line side or the load side of the switch.

Wiring Diagram 4

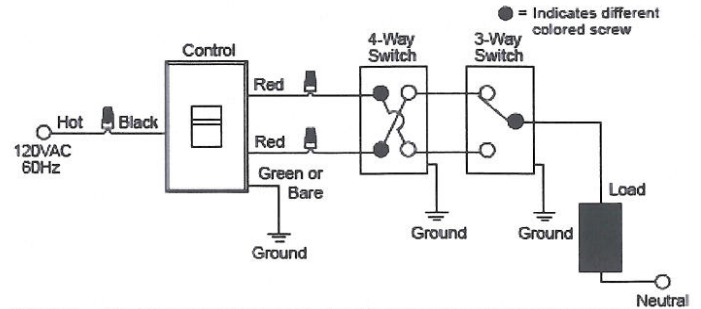

NOTE: Controls may be wired on either the line side or the load side of the switch.

Wiring Diagram 5

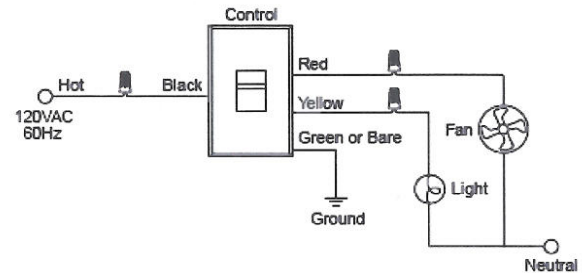

Wiring Diagram 6

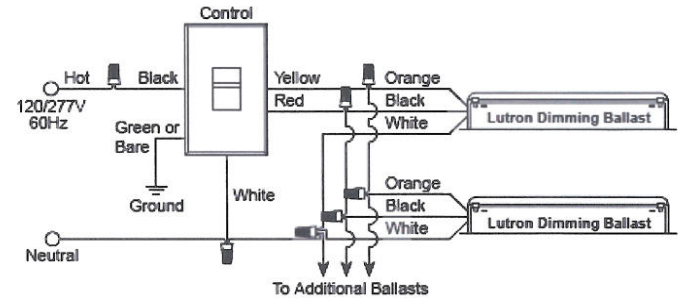

Wiring Diagram 7

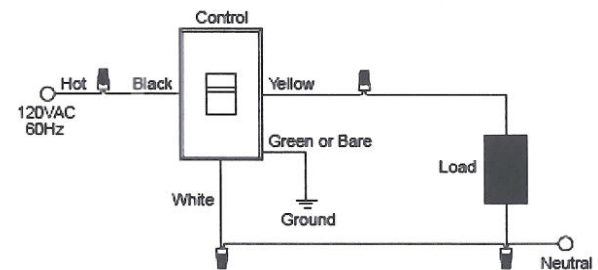

Mounting Instructions

1. Push wires into wallbox, allowing room for control to be inserted. Do not pinch wires between wallbox and control.
2. Mount control to wallbox using screws provided. Controls must be mounted vertically. See stamp on control for correct positioning.
3. Mount adapter plate with mounting screws provided (see below).

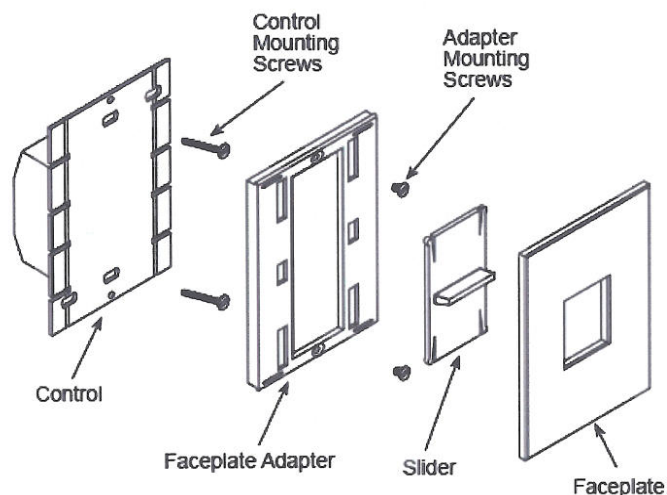

4. Snap on slider and faceplate.

Operation

Slide-to-Off Controls

Raise slider to increase light intensity. Lower slider to decrease light intensity and turn off.

Preset Controls

Push button in center of slider to turn lights on to preset level (set by slider) and to turn lights off. Raise slider to increase light intensity. Lower slider to decrease light intensity.

3-Way and 4-Way Controls

When switching power from remote location, lights will turn on to level set on control (by slider), or turn off. Raise slider to increase light intensity. Lower slider to decrease light intensity and turn off.

Fluorescent Controls

Controls are factory calibrated and do not require low-end light adjustment. If lamps flicker or drop out at the minimum dimming level there may be an installation error. Continued use of the system in this mode will cause premature lamp failure. If this is occurring, call the **Lutron Technical Assistance Hotline** at: 1-800-523-9466.

To ensure proper dimming performance and full lamp life, fluorescent lamps must be operated at full intensity for 100 hours prior to dimming.

Multigang Installation

Multiple controls can be installed in a common gangable wallbox or a series of interconnected wallboxes for a clean, consolidated appearance. Lutron multigang faceplates are available to complete the installation. Refer to instruction sheet supplied with multigang faceplates for installation.

For new installations, controls can be ganged without removing side sections, but, to reduce the size of the multigang installation or to fit existing wallboxes, inner side sections must be removed. Because side sections are designed to dissipate heat, removing them requires derating the capacity of the control.

Note: When ganging any combination of small and large controls, place all small controls on one end of the gang and all large controls on the other. Use the chart below to determine the size and rating of each control.

Control Size and Rating Chart

Model	Control Size	No Sides Removed	1 Side Removed	2 Sides Removed
NT-600	S	600W	500W	400W
NT-1000	S	1000W	900W	700W
NT-1500	L	1500W	1250W	1000W
NT-2000*	L	1950W	—	—
NTLV-600	S	600VA	500VA	300VA
NTLV-1000	S	1000VA	900VA	700VA
NTLV-1500	L	1500VA	1200VA	1000VA
NT-603P	S	600W	500W	400W
NT-1003P	S	1000W	900W	700W
NT-1503P	L	1500W	1250W	1000W
NTLV-603P	S	600VA	500VA	300VA
NTLV-1003P	S	1000VA	900VA	700VA
NTLV-1503P	L	1500VA	1250VA	1000VA
NTELV-300	S	300W	300W	250W
NTELV-600	S	600W	500W	400W
NTFS-6E	S	6A	4.2A	2.5A
NTFS-12E	L	12A	10A	8.3A
NTFSQ	S	1.5A	1.5A	1.5A
NTF-10	S	16A	16A	16A
NTF-10-277	S	8A	8A	8A
NTFTU-5A	S	5A	4A	3.3A
NT-1PS	S	20A	20A	20A
NT-3PS	S	20A	20A	20A
NT-4PS	S	20A	20A	20A

*NT-2000 cannot have side sections removed.

The Wallbox Requirement Charts on this sheet do not apply for the NT-2000. See the NT-2000 instruction sheet for the appropriate requirements.

Worldwide Technical and Sales Assistance

If you have questions concerning the installation or operation of these products, call the **Lutron Technical Assistance Hotline**. Please provide exact model number when calling.

(800) 523-9466 (U.S.A., Canada, and the Caribbean)

Other Countries call (610) 282-3800

Fax (610) 282-3090

Visit our Web site at www.lutron.com

Side Sections Removed

(Derating Required)

Wallbox Requirement Chart

		Number of Small Controls						
		0	1	2	3	4	5	6
Number of Large Controls	0	0	1	2	3	4	5	6
	1	1	3	4	5	6	7	8
	2	2	3	5	6	7	8	9
	3	3	5	7	8	9	10	11
		4	7	9	10	11	12	13

Remove inner side sections from controls. Using pliers, bend side sections up and down until they break off.

Remove inner side sections (shaded) only.

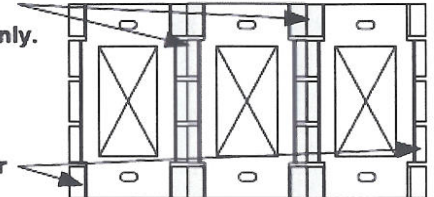

Do not remove outer side sections.

No Side Sections Removed

(Derating Not Required)

Wallbox Requirement Chart

		Number of Small Controls				
		0	1	2	3	4
Number of Large Controls	0	0	1	1+1	4	4+1
	1	1	3	5	6	8
	2	2	4	6	7	10
	3	3	6	8	10	11
		4	9	11	12	14

Note: When ganging an even number of small controls with side sections intact, use gangable 3"x2" wallboxes. Space an additional wallbox 3/4" apart from the other wallboxes. A 3/4" chase nipple is recommended as a spacer between wallboxes.

Example: Wallbox arrangement required for ganging 4 small controls with no side sections removed:

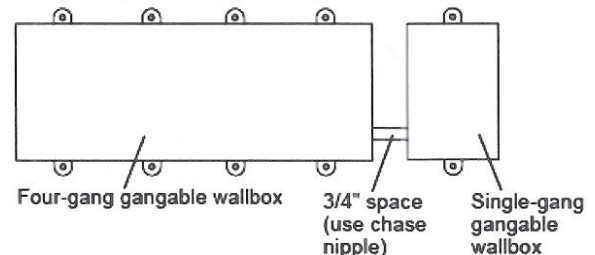

Warranty

Lutron will, at its option, repair or replace any unit that is defective in materials or manufacture within one year after purchase. For warranty service, return unit to place of purchase or mail to LUTRON at 7200 Suter Road, Coopersburg, PA 18036-1299, postage prepaid.

This warranty is in lieu of all other warranties, express or implied, and the implied warranty of merchantability is limited to one year from purchase. This warranty does not cover the cost of installation, removal, or reinstallation, or damage resulting from misuse, abuse, or damage resulting from improper wiring or installation.

This warranty gives you specific legal rights, and you may also have other rights which vary from state to state. Some states do not allow the exclusion or limitation of incidental or consequential damages or limitations on how long an implied warranty may last, so the above limitations may not apply to you.

Lutron Electronics Co., Inc.

7200 Suter Road

Coopersburg, PA 18036-1299 U.S.A.

Made and printed in U.S.A. 8/99 P/N 030-408 Rev. C