

DOOR(s)				
110a	110b	111a	111b	112
125	126	130c	143	149
157a	204	206	222	240

SUPPLIED AND INSTALLED BY OTHERS:

- ELECTRIC STRIKE 100&CLB
- DOOR POSITION SWITCH DPS-M-BK
- WIRE HARNESS QC-C1500P
- POWER SUPPLY AGD1

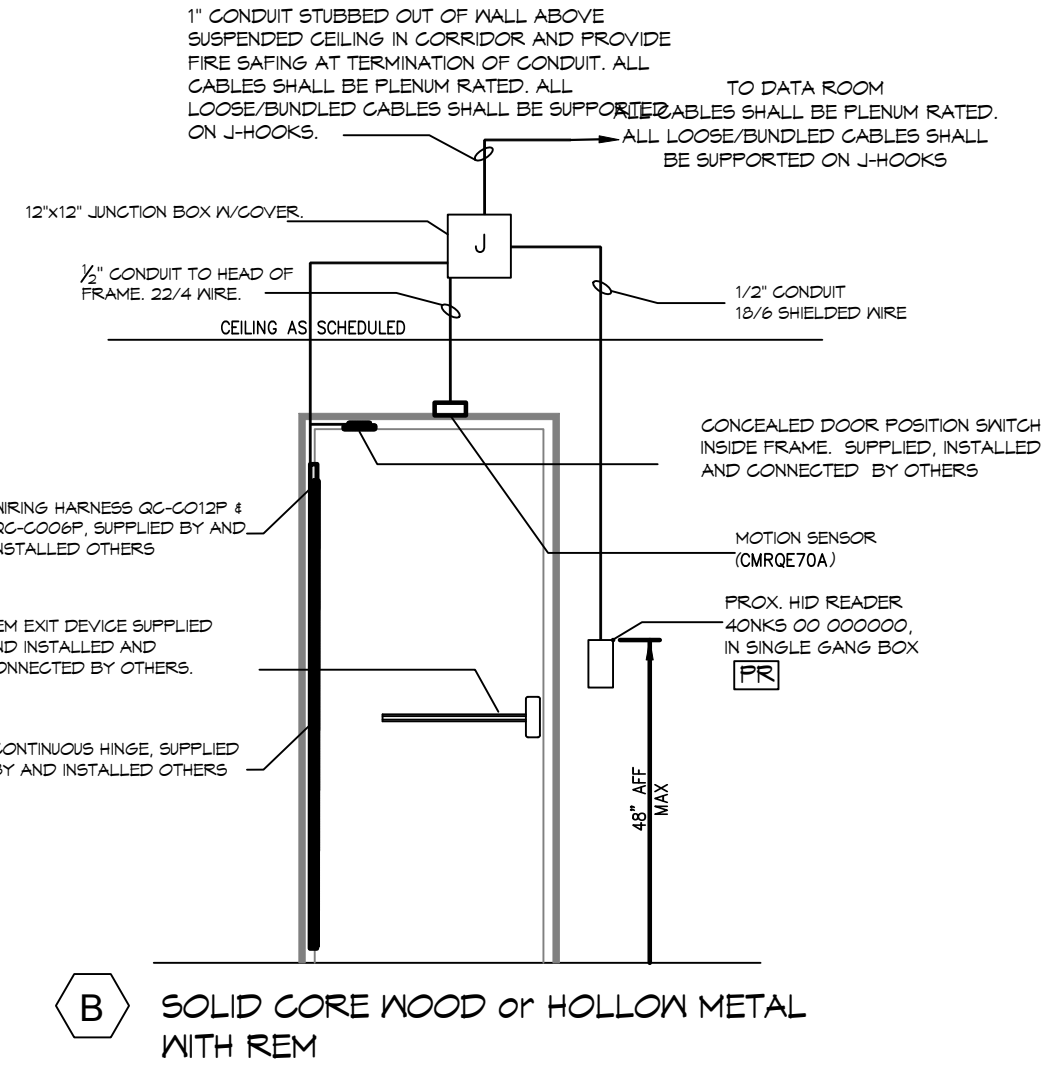

DOOR(s)				
136a	136b	138b	153	156

SUPPLIED AND INSTALLED BY OTHERS:

- CONTINUOUS HINGE HG-305 X KMP55 X EL-12
- RIM EXIT DEVICE EDB200A X TH95TET CT6d
- DOOR POSITION SWITCH DPS-M-BK
- WIRING HARNESS QC-C012P
- WIRING HARNESS QC-C006P
- POWER SUPPLY AGD1

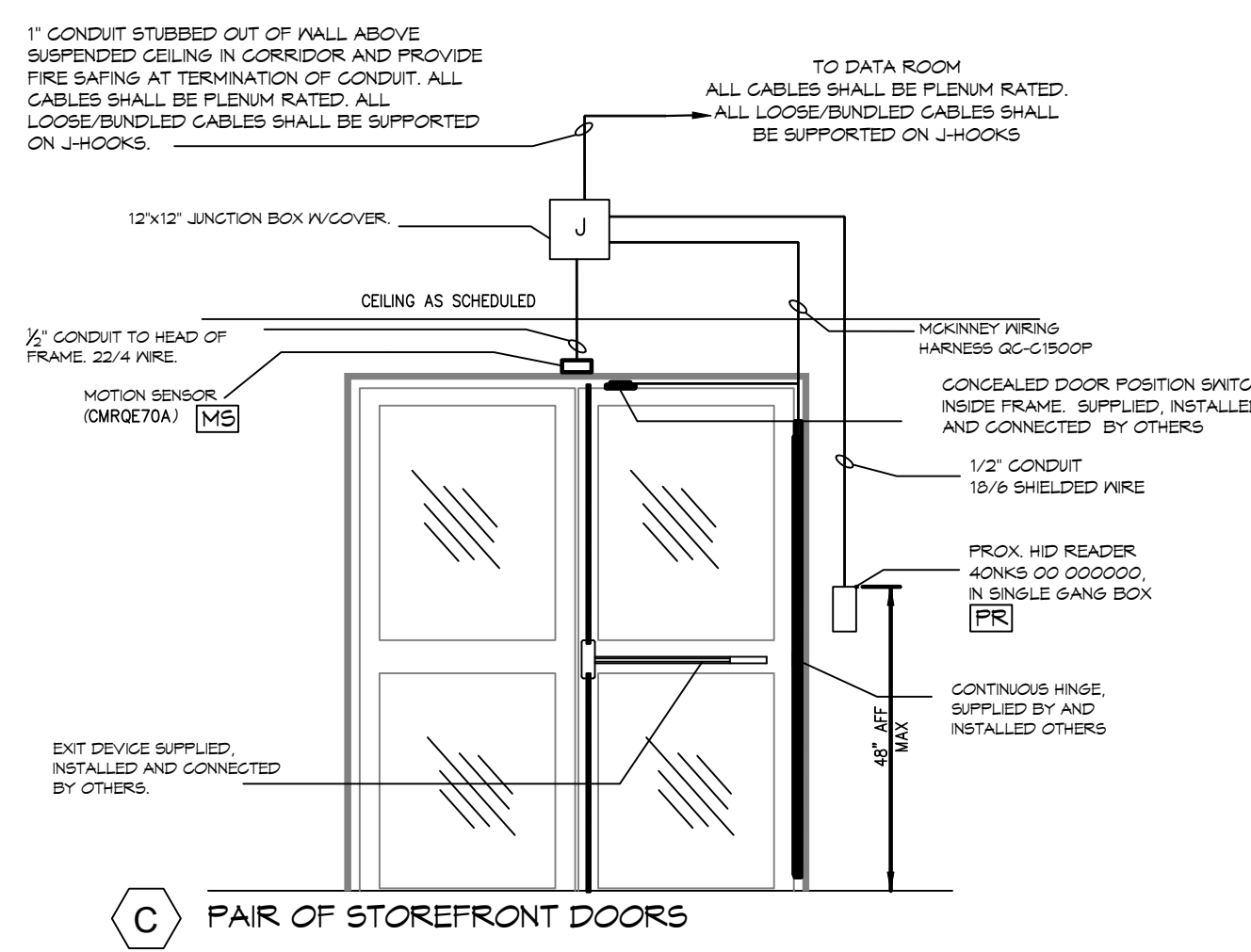

DOOR(s)				
124a				

SUPPLIED AND INSTALLED BY OTHERS:

- EXIT DEVICE EDB200A X TH95TET CT6d
- DOOR POSITION SWITCH BK DPS-M-BK
- WIRING HARNESS QC-C012P
- WIRING HARNESS QC-C006P
- POWER SUPPLY AGD1

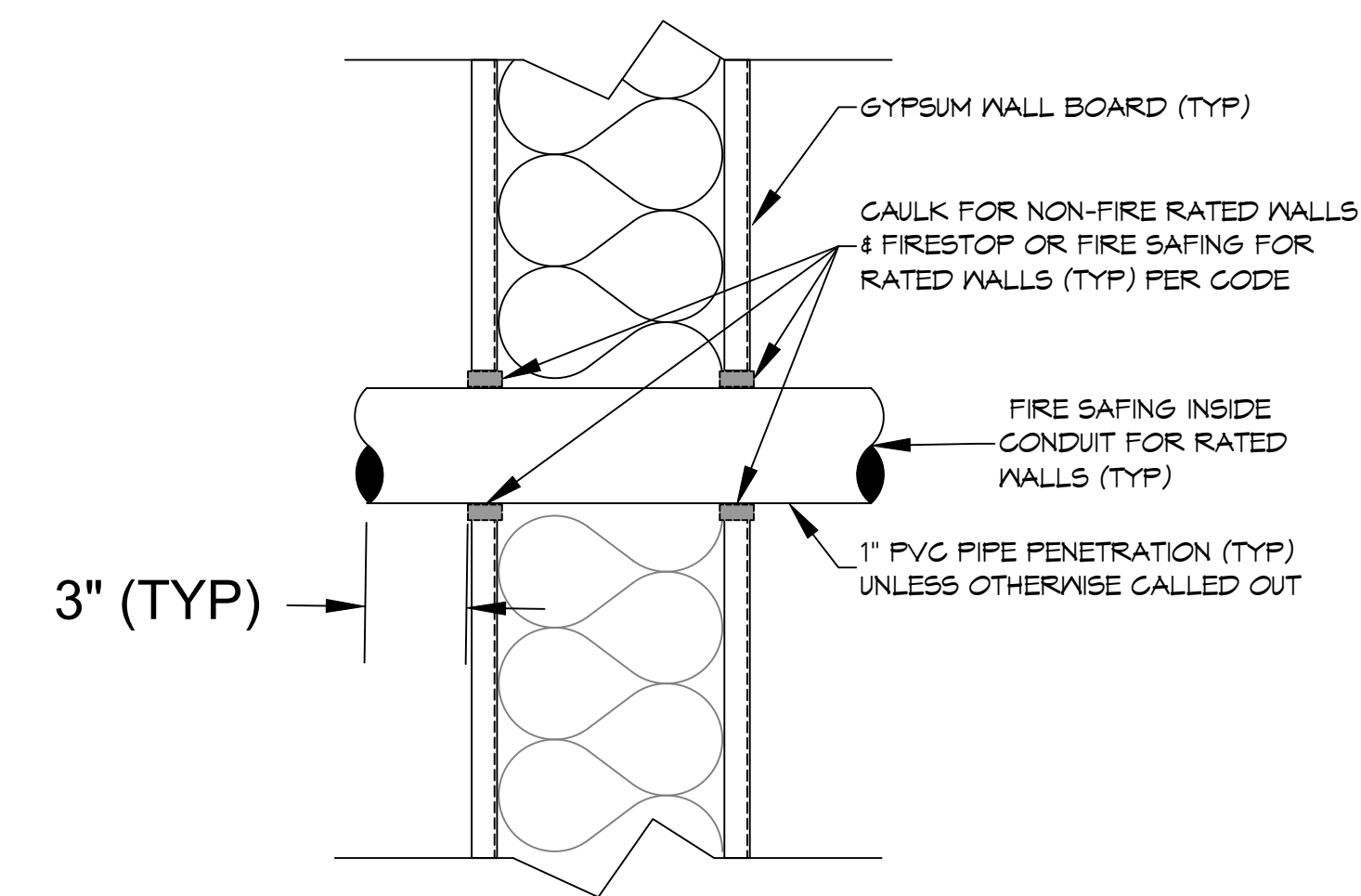

TYPICAL PIPE SLEEVE PENETRATION DETAIL

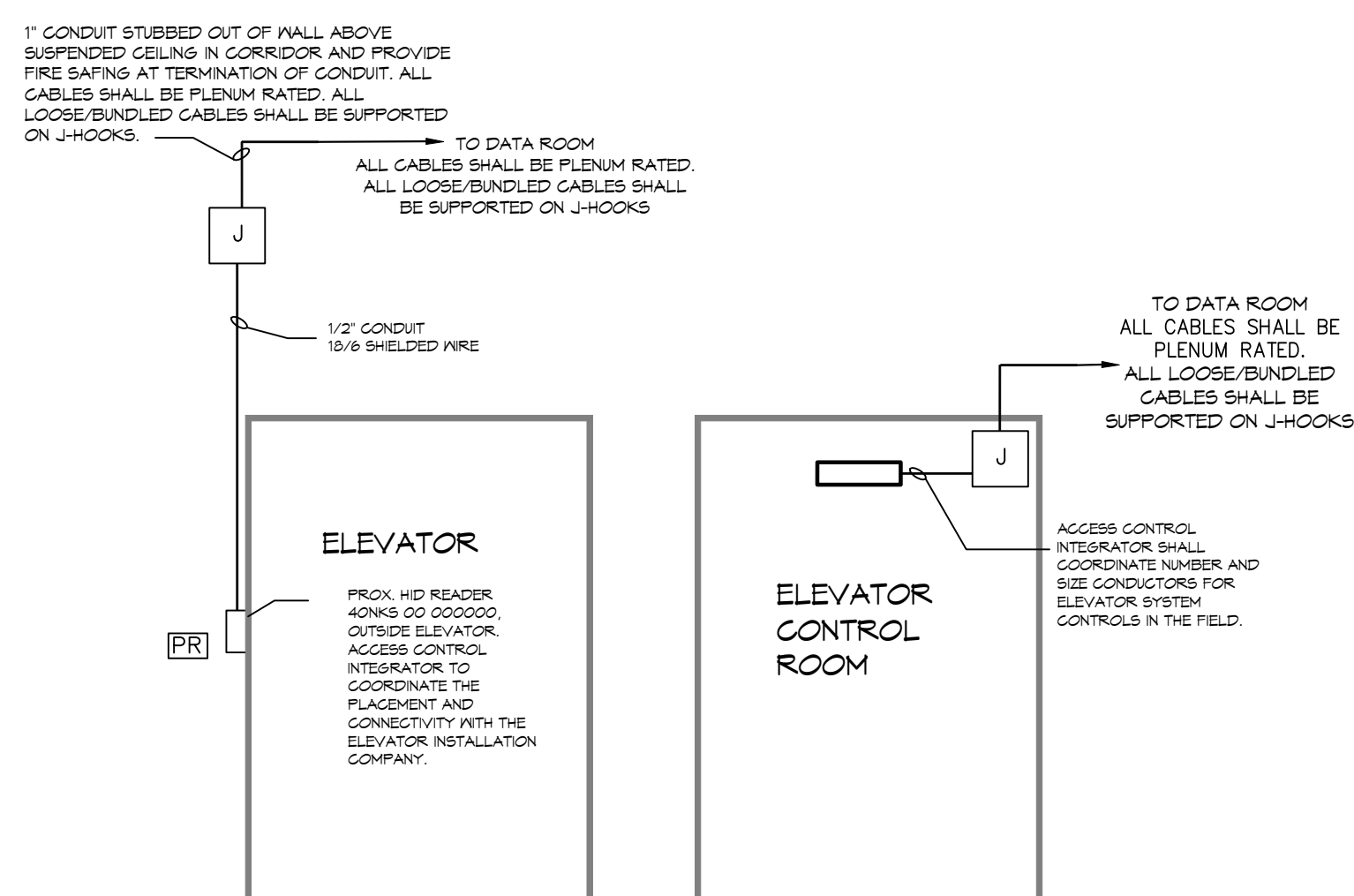

D ELEVATORS

DOOR(s)	
ELEV 106a	ELEV 106b

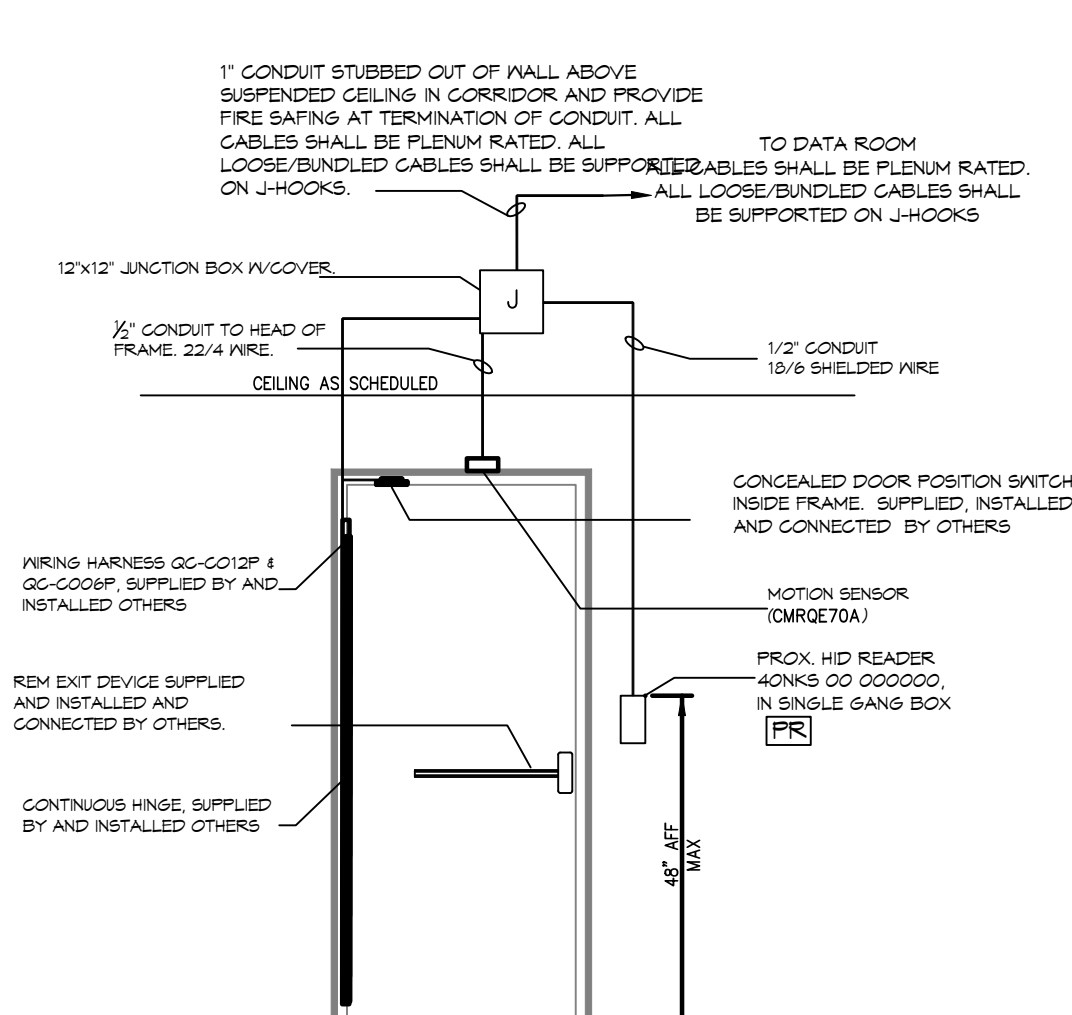

E SOLID CORE WOOD or HOLLOW METAL WITH REM

DOOR(s)				
136a	136b	138b	153	156

SUPPLIED AND INSTALLED BY OTHERS:

- CONTINUOUS HINGE HG-305 X 10" X EL-12
- RIM EXIT DEVICE EDB200A X 1.990SET CT6d
- DOOR POSITION SWITCH DPS-M-BK
- WIRING HARNESS QC-C1500P
- WIRING HARNESS QC-C012P
- POWER SUPPLY AGD1

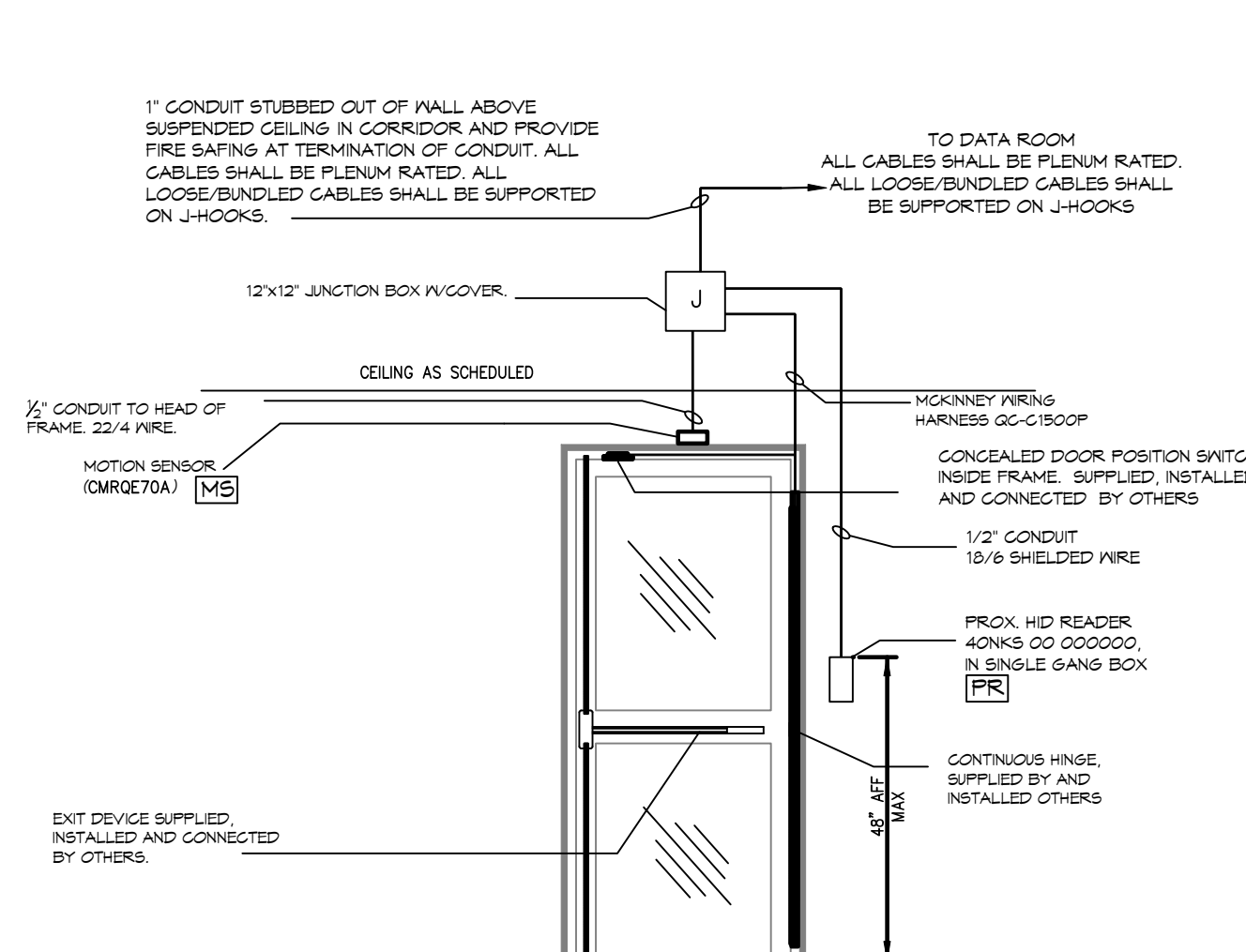

F PAIR OF STOREFRONT DOORS

DOOR(s)				
100a				

SUPPLIED AND INSTALLED BY OTHERS:

- EXIT DEVICE EDB200A X TH95TET CT6d
- DOOR POSITION SWITCH BK DPS-M-BK
- WIRING HARNESS QC-C012P
- WIRING HARNESS QC-C006P
- POWER SUPPLY AGD1

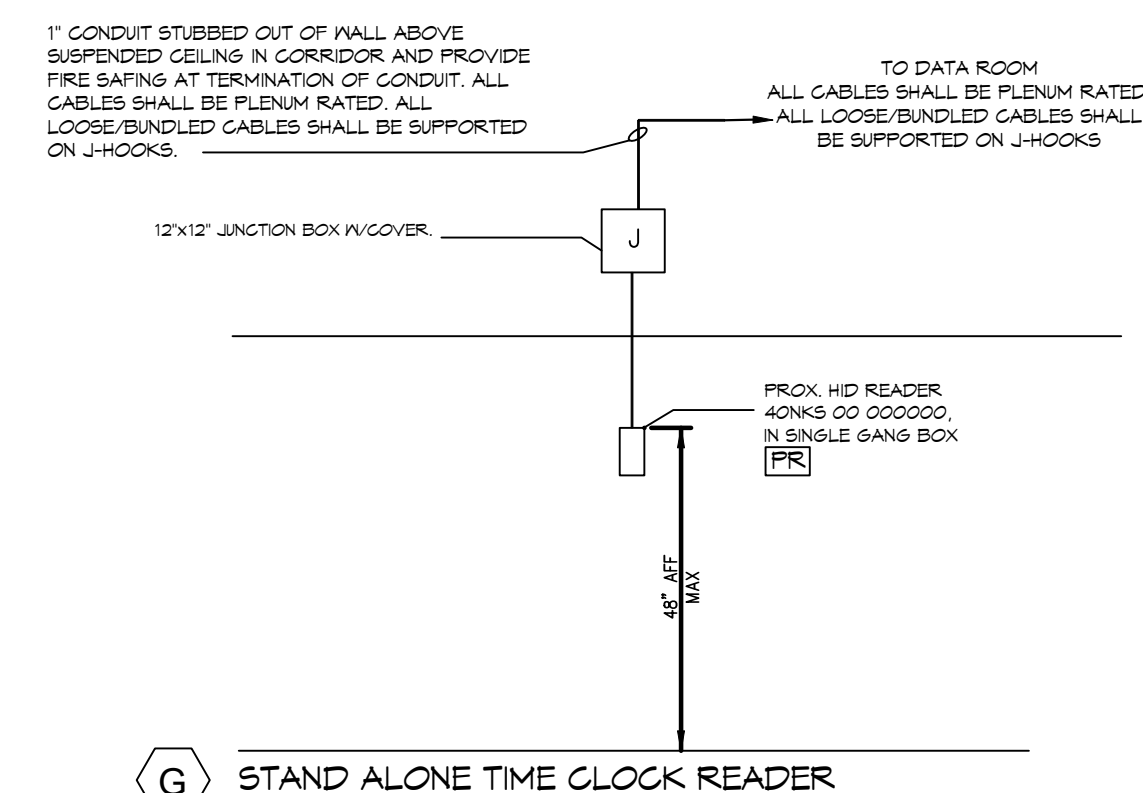

G STAND ALONE TIME CLOCK READER

DOOR(s)				
124b				

SUPPLIED AND INSTALLED BY OTHERS:

- N/A

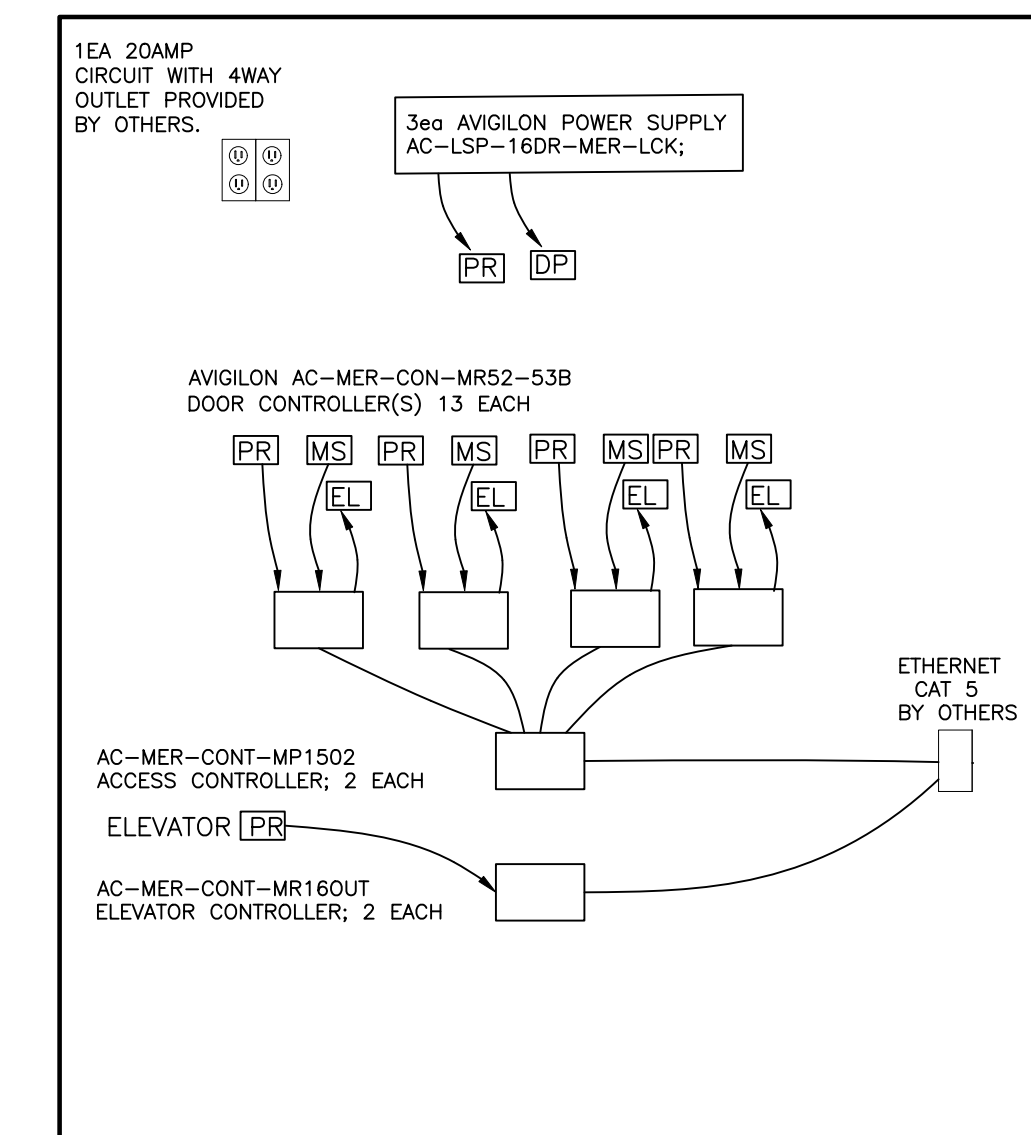

ACCESS CONTROL SYMBOL LEGEND

- [PR] = PROX. HID READER
- [MS] = MOTION SENSOR
- [DP] = DOOR POSITION SWITCH - BY OTHERS.
- [EH] = ELECTRIC HINGE - BY OTHERS.
- [EL] = ELECTRIC RELEASE LEVER - BY OTHERS
- [J] = 12"x12" JUNCTION BOX

REVISIONS	DATE
1 ADD DETAILS FOR DOORS 100a, 124b & 222	2/2/2026

SEAL:

SECURITY ACCESS
NORTH OAKS PHYSICAL THERAPY
1870 PAUL VERA BLVD DR.
HARRISBURG, LA 70402
JOB No: 2519 DATE: 10/10/2025
DRAWN BY: CND CHECKED BY: BAK

SHEET TITLE:
DOOR DETAILS
DRAWING NUMBER:
SEC 0.1
SHEET No: 13 of #