

Ordering Information

Applicable toilet:		
With standard tank	K-3433	shown
With insuliner	K-3433-U	not shown
With locks	K-3433-T	not shown
With cover locks and insuliner tank	K-3433-UT	not shown
Accessories/hardware:		
3/8" supply	K-7637	recommended
Floor bolts (pr.)	21401	recommended
Seat	K-4662	recommended

Product Information

Fixture:	
Configuration	2-piece, round front
Gallons per flush	1.6
Passageway	2"
Water depth from rim	6"
Seat post hole centers	5-1/2"
Included Components:	
Bowl	K-4277
Tank	K-4621
Tank cover	84095
Trip lever	K-9404

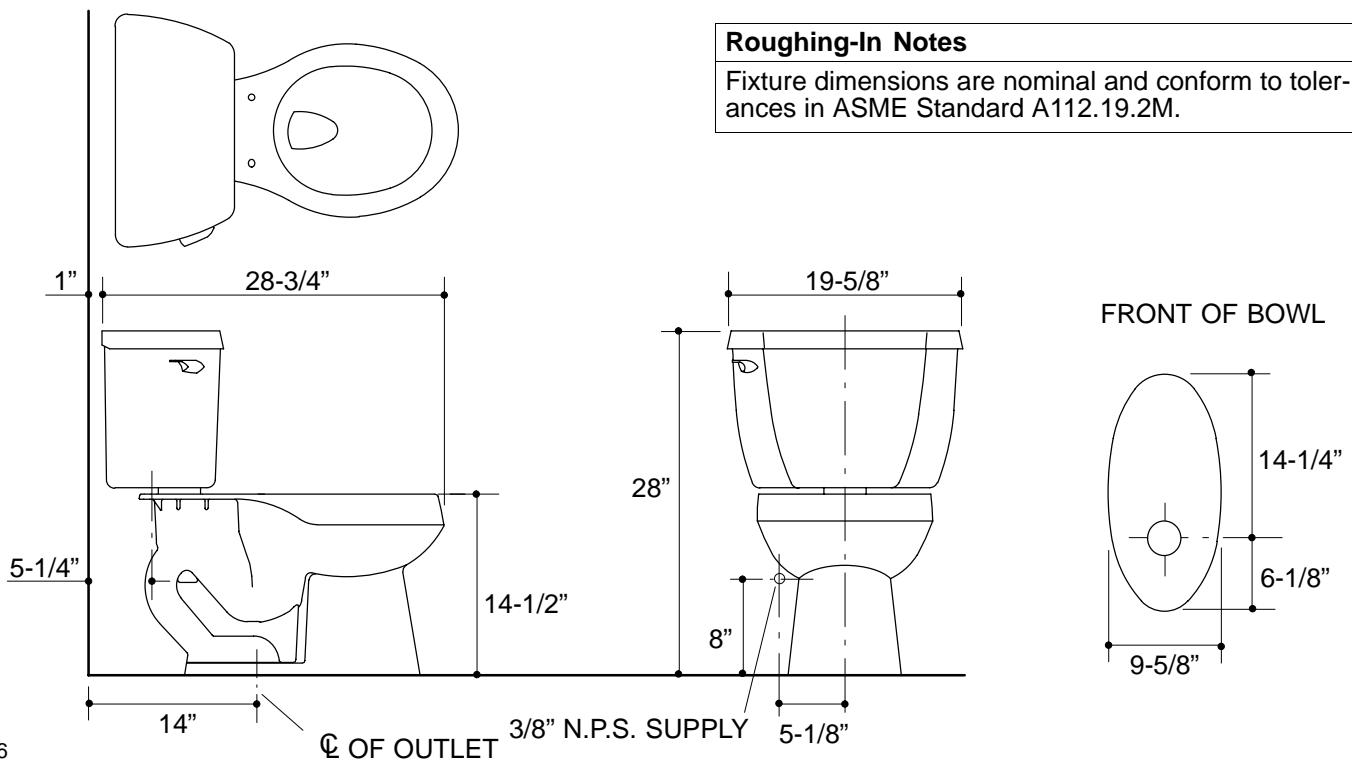

Roughing-In Notes
Fixture dimensions are nominal and conform to tolerances in ASME Standard A112.19.2M.