



KENT DESIGN BUILD, INC.

This submittal has been reviewed for general conformance with contract documents only. This review shall not constitute a complete check for detailed dimensions or count or serve to relieve the preparer of contractual responsibility for any error or deviation from contract requirements.

REVIEWED
 REVIEWED AS NOTED
 REVISE & RESUBMIT

BY: *kcarter* JOB NO.: 25044

DATE: 1/30/2026

SUBMITTAL#: 087100-02B

DATE: January 30, 2026

TO: Holly & Smith Architects
208 North Cate Street
Hammond, LA 70401

RE: North Oaks Outpatient Renovation
Hammond, LA
Kent Project No. 25044

PRODUCT/MATERIAL: Door Hardware

SECTION NO. & NAME: 087100 – Door Hardware

TYPE OF SUBMITTAL: Product Data

CONTRACTORS SUBMITTAL NO: 087100-02B

DATE OF SUBMITTAL: January 30, 2026

SUBCONTRACTOR/SUPPLIER: Himmel’s Architectural Door and Hardware

DEVIATIONS: N/A

REMARKS:

H/S :
 1. modify frames for added card readers
 2. note comments on hardware

Reviewed, No Exceptions Taken
 Reviewed, Note Comments By: Matthew Romano
 Revise & Resubmit
 Rejected, Resubmit Date: 03.04.26

BY: *Kamen Carter*
 Project Manager
 Kent Design Build, Inc.

H/S HOLLY & SMITH ARCHITECTS, APAC

REVIEW IS ONLY FOR GENERAL CONFORMANCE WITH THE DESIGN CONCEPT AND THE INFORMATION IN THE CONTRACT DOCUMENTS. COMMENTS MADE AS PART OF THIS REVIEW DO NOT RELIEVE CONTRACTOR FROM COMPLIANCE WITH THE CONTRACT DOCUMENTS, APPLICABLE CODES, AND LAWS, ALL OF WHICH HAVE PRIORITY OVER THIS SUBMITTAL. ARCHITECT DOES NOT WARRANT OR REPRESENT THAT THE INFORMATION WITHIN THE SUBMITTAL IS EITHER ACCURATE OR COMPLETE. CONTRACTOR IS RESPONSIBLE FOR: ALL DIMENSIONS, QUANTITIES, AND PERFORMANCE REQUIREMENTS, WHICH SHALL BE CONFIRMED AND CORRELATED AT THE JOB SITE; ALL INFORMATION THAT PERTAINS SOLELY TO FABRICATION PROCESSES OR TO TECHNIQUES OF CONSTRUCTION; ALL COORDINATION OF THE WORK WITH THAT OF ALL OTHER TRADES; AND PERFORMING THE WORK IN A SATISFACTORY MANNER.



Himmel's Architectural Door & Hardware, LLC - NO

5500 Jefferson Hwy., New Orleans, LA 70123

Tel: (504) 302-2150 Fax: (504) 302-7263

North Oaks Rehabilitation And Sports Performance Center 304700

SCHEDULE OF FINISHED HARDWARE

REVISED DATE | January 22, 2026

ARCHITECT

CONTRACTOR | Kent Design Build, Inc. -

DETAILED BY | Don Bowers

Note | To keep the project moving in a timely manner, we ask that submittals be returned approved within three (3) weeks from submitted date. Delays in receiving approvals may impact lead times, pricing and material need by dates.

Opening List

New Const.

Opening	Hdw Set	Hdw Heading	Opening Label	Door Type	Frame Type
100A	30.0	30.0		D-3-AL	F-3-AL
100B	30.0	30.0		D-14-AL	F-3-AL
101	4.0	4.0		D-2-WD	F-1-HM
102	25.0	25.0		D-1-WD	F-1-HM
104	27.0	27.0		D-1-WD	F-1-HM
105	27.0	27.0		D-1-WD	F-1-HM
108	20.0	20.0		D-1-WD	F-1-HM
109	22.0	22.1		D-1-WD	F-1-HM
110A	13.0	13.0		D-1-WD	F-1-HM
110B	13.0	13.0		D-1-WD	F-1-HM
111A	13.0	13.0		D-1-WD	F-1-HM
111B	13.0	13.0		D-1-WD	F-1-HM
112	12.0	12.0	SMOKE	D-1-WD	F-1-HM
113	21.0	21.0		D-1-WD	F-1-HM
114	21.0	21.0		D-1-WD	F-1-HM
115	21.0	21.0		D-1-WD	F-1-HM
116	21.0	21.0		D-1-WD	F-1-HM
117	21.0	21.0		D-1-WD	F-1-HM
118	21.0	21.0		D-1-WD	F-1-HM
121	20.0	20.1		D-1-WD	F-1-HM
122	16.0	16.0A		D-1-WD	F-1-HM
125	10.1	10.1		D-1-WD	F-1-HM
131	9.0	9.0		D-5-AL	F-3-AL
132	9.0	9.0		D-5-AL	F-3-AL
133	8.0	8.1		D-5-AL	F-3-AL
134	21.0	21.0		D-1-WD	F-1-HM
135	21.0	21.0		D-1-WD	F-1-HM
137	21.0	21.0		D-1-WD	F-1-HM
138A	5.0	5.0		D-2-WD	F-1-HM
138B	1.1	1.1		D-7-HM	F-1-HM
138D	7.0	7.0		D-1-WD	F-1-HM
139	21.0	21.0		D-1-WD	F-1-HM
140	21.0	21.0		D-1-WD	F-1-HM
141	23.0	23.2		D-1-WD	F-1-HM
142	16.0	16.1		D-1-WD	F-1-HM
143	10.0	10.2A	SMOKE	D-1-WD	F-1-HM
145	22.0	22.0		D-1-WD	F-1-HM
146	22.0	22.0		D-1-WD	F-1-HM
149	11.0	11.0A	60 MIN.	D-1-WD	F-1-HM
151				CO-CO	F-2-HM
152	6.0	6.0		D-1-WD	F-1-HM
157A	10.0	10.0A	SMOKE	D-1-WD	F-1-HM
201	8.0	8.0		D-5-AL	F-3-AL
203	22.0	22.1		D-1-WD	F-1-HM

North Oaks Rehabilitation And Sports Performance Center
304700

Opening	Hdw Set	Hdw Heading	Opening Label	Door Type	Frame Type
204	16.0	16.0		D-1-WD	F-1-HM
205	15.0	15.1		D-1-WD	F-1-HM
206	19.0	19.0A		D-1-WD	F-1-HM
206B	22.0	22.2		D-1-WD	F-1-HM
207	23.0	23.0		D-1-WD	F-1-HM
208	18.0	18.0	SMOKE	D-1-WD	F-1-HM
209	14.0	14.0		D-1-WD	F-1-HM
210	2.0	2.0A		D-1-HM	F-1-HM
211	9.0	9.0		D-5-AL	F-3-AL
212	21.0	21.0		D-6-WD	F-1-HM
213	21.0	21.0		D-6-WD	F-1-HM
214	21.0	21.0		D-6-WD	F-1-HM
215	21.0	21.0		D-6-WD	F-1-HM
216	21.0	21.0		D-6-WD	F-1-HM
217	19.0	19.0		D-1-WD	F-1-HM
218	16.0	16.1B	60Min	D-1-WD	F-1-HM
219	14.0	14.0		D-6-WD	F-1-HM
220	14.0	14.0		D-1-WD	F-1-HM
221	18.0	18.0A	SMOKE	D-1-WD	F-1-HM
222	16.0	16.1		D-1-WD	F-1-HM
224	21.0	21.0		D-1-WD	F-1-HM
225	22.0	22.1		D-1-WD	F-1-HM
225B	22.0	22.1		D-1-WD	F-1-HM
226	18.0	18.1		D-1-WD	F-1-HM
228	21.0	21.0		D-1-WD	F-1-HM
229	20.0	20.0		D-2-WD	F-1-HM
231	21.0	21.0		D-1-WD	F-1-HM
232	21.0	21.0		D-1-WD	F-1-HM
233	7.0	7.2		D-1-WD	F-1-HM
235	6.3	6.3	60Min	D-1-WD	F-1-HM
236	24.0	24.0		D-1-WD	F-1-HM
237	26.0	26.0		D-1-WD	F-1-HM
238	26.0	26.0		D-1-WD	F-1-HM
239	17.0	17.0		D-1-WD	F-1-HM
240	10.0	10.0		D-1-WD	F-1-HM
241	25.0	25.0		D-1-WD	F-1-HM
242	25.0	25.0		D-1-WD	F-1-HM
243	25.0	25.0		D-1-WD	F-1-HM
244	26.0	26.0		D-1-WD	F-1-HM
248	16.0	16.0		D-1-WD	F-1-HM
249	25.0	25.0		D-1-WD	F-1-HM
250	25.0	25.0		D-1-WD	F-1-HM
251	22.0	22.0		D-1-WD	F-1-HM
252	22.0	22.0		D-1-WD	F-1-HM
255	3.0	3.0		D-7-HM	F-1-HM

Existing

Opening	Hdw Set	Hdw Heading	Opening Label	Door Type	Frame Type
124A	2.1	2.1		D-4-AL	F-3-AL
124B	6.1	6.1	60Min	D-1-WD	EF-2-WD
126	10.0	10.0A	60 MIN.	D-1-WD	EF-1-HM
127	16.1	16.1C		D-1-WD	EF-1-HM
136A	7.1	7.1	60 MIN.	D-1-WD	F-1-HM
136B	7.1	7.1	60 MIN.	D-1-WD	F-1-HM
138C	6.2	6.2		D-1-WD	F-1-HM
144	7.0	7.2		D-1-WD	F-1-HM
150	29.1	29.1	60 MIN.	ED-1-HM	EF-1-HM
150A	29.0	29.0		ED-5-OHD	OHD-OHD
150C	28.0	28.0		ED-5-OHD	OHD-OHD
153C	29.1	29.1	60 MIN.	ED-1-HM	EF-1-HM
156	7.1	7.1A	60 MIN.	D-1-WD	EF-1-HM
157B	28.0	28.0		ED-5-OHD	OHD-OHD
234	16.0	16.1		D-1-WD	F-1-HM
253	16.0	16.1A		D-1-WD	F-1-HM
254	6.3	6.3A	60 MIN.	D-1-WD	EF-1-HM
271	29.1	29.1		ED-1-HM	EF-1-HM

Manufacturer List

Code	Name
CR	Corbin Russwin
HS	HES
MA	Markar
MC	McKinney
MISC	Miscellaneous Items
PE	Pemko
RO	Rockwood
RX	Rixson
SN	Securitron

Finish List

Code	Description
26D	Satin Chrome
626	Satin Chromium Plated
630	Satin Stainless Steel
689	Aluminum Painted
GRAY	Gray
US26D	Chromium Plated, Dull
US32D	Stainless Steel, Dull

Option List

Code	Description
A10	HEAVY DUTY REGULAR ARM
A11	HEAVY DUTY SPRING STOP ARM
A3	HEAVY DUTY ARM
A4	HEAVY DUTY BACKSTOP
BF	Barrier Free Projection - Pull Plates
CSK	COUNTERSUNK HOLES (per hundred Sq. In.)
CT6D	IC 6 PIN DISPOSABLE TEMP CORE
CT6D	IC 6 PIN DISPOSABLE TEMP CORE-DBL
CT6D	IC 6 PIN DISPOSABLE TEMP CORE-SGL
D	Delayed Egress
EL-8	ElectroLYNX Current Transfer (8 Wire)
H3	KEYWAY
M34	ERGONOMIC THUMB TURN
M55	LESS BOTTOM ROD
M92	TOUCHBAR MONITORING OR SIGNALING
MELR	Motorized Electric Latch Retraction
MK	MASTER KEYED IC
VKC2	VISUAL KEY CONTROL-CYLINDER AND KEYS-SGL
W048	Door Width 48-5/8"

Hardware Schedule

Heading #1.1 (Set #1.1)

1 Single Door #**138B** EXTERIOR from BALANCE & NEURO GYM 138 LHR

Opening Description: 3' 6" x 7' 0" x 1 3/4" x HMD Type D-7-HM x HMF Type F-1-HM

Note: Doors are normally closed and secure. Presentation of valid credentials will allow entry by pull. Upon loss of power, doors will remain secure. Free egress at all times.

Coordinate voltage, operation and electrical characteristics with all related trades. Card reader, wiring and connections by security provider.

1 Continuous Hinge	HG-305 7'0" EL-8	RH	630	MA
1 Exit Device	ED5200 x TH957ET CT6D M92 MELR W048		630	CR
1 Core Only	CR8000 H3 MK VKC2		626	CR
1 Closer	DC6210 A4		689	CR
1 Protection Plate	K1050 10" x 40" CSK		US32D	RO
Note: Push Side Mount				
1 Wiring Harness	QC-C1500P			MC
Note: Wiring Harness from Power Transfer / Electric Hinge to Power Source Provided By Others				
1 Card Reader(By Others)	CARD READER BY SECURITY VENDOR			MISC
1 Switch	DPS-M-BK			SN
Note: 3/4" Hole Prep - Located 6" From Strike Jamb to C/L or Hole Prep On Frame				
Top Rail Located				
1 Power Supply	AQD1			SN
1 Wiring Harness	QC-C012P			MC
1 Door Bottom	315 CN 42"			PE
1 Threshold	2005 AT 42"			PE

Heading #2.0A (Set #2.0)

1 Single Door #**210** EXTERIOR from PEDS GYM 210 RHR

Opening Description: 3' 6" x 7' 0" x 1 3/4" x HMD Type D-1-HM x HMF Type F-1-HM

1 Continuous Hinge	HG-305 7'0" EL-8	LH	630	MA
1 Exit Device	ED5200 x L9905ET CT6D D W048	RHR	630	CR
1 Core Only	CR8000 H3 MK VKC2		626	CR
1 Closer	DC6210 A4		689	CR
1 Protection Plate	K1050 10" x 40" CSK		US32D	RO
Note: Push Side Mount				
1 Wiring Harness	QC-C1500P			MC
Note: Wiring Harness from Power Transfer / Electric Hinge to Power Source Provided By Others				
1 Card Reader(By Others)	CARD READER BY SECURITY VENDOR			MISC
1 Power Supply	AQD1			SN
1 Wiring Harness	QC-C012P			MC
1 Switch	DPS-W-BK			SN
1 Door Bottom	315 CN 42"			PE
1 Threshold	2005 AT 42"			PE

weatherstripping

Heading #2.1 (Set #2.1)

1 Pair Doors #124A new hdw EXTERIOR from VEST 124 LHRA

Opening Description: 2 - 2' 9 3/8" x 6' 10 5/8" Type D-4-AL Type F-3-AL

Note: Doors are normally closed and secure. Unauthorized exit attempt will initiate immediate alarm and 15-second delay to exit. Valid credentials will bypass alarm for immediate exit. Upon loss of power or signal from fire control, doors will allow free and immediate egress.

Coordinate voltage, operation and electrical characteristics with all related trades. Card reader, wiring and connections by security provider.

1 Pivot Set	195 3/4" OFFSET	LH	626	RX
1 Pivot Set	195 3/4" OFFSET	RH	626	RX
1 Electrified Pivot	EM19 8-WIRE	LH	626	RX
1 Electrified Pivot	EM19 8-WIRE	RH	626	RX
1 Exit Device	ED4800 x P1057ET CT6D M92 MELR	LHR	630	CR
1 Exit Device	ED4800 x P1050ET M92	RHR	630	CR
1 Core Only	CR8000 H3 MK VKC2		626	CR
2 Closer	DC6210 A11		689	CR
2 Wiring Harness	QC-C1500P			MC

Note: Wiring Harness from Power Transfer / Electric Hinge to Power Source Provided By Others

2 Switch DPS-M-BK SN

Note: 3/4" Hole Prep - Located 6" From Strike Jamb to C/L or Hole Prep On Frame

Top Rail Located

1 Power Supply AQD1 SN

weatherstripping

Heading #3.0 (Set #3.0)

1 Single Door #255 EXTERIOR from MECH 255 RHR

Opening Description: 3' 0" x 7' 0" x 1 3/4" x HMD Type D-7-HM x HMF Type F-1-HM

1 Continuous Hinge	HG-305 7'0"		630	MA
1 Mortise Lockset	ML2057 LWA CT6D	RHR	630	CR
1 Core Only	CR8000 H3 MK VKC2		626	CR
1 Closer	DC6210 A4		689	CR
1 Protection Plate	K1050 10" x 34" CSK		US32D	RO

Note: Push Side Mount

1 Switch DPS-M-BK SN

Note: 3/4" Hole Prep - Located 6" From Strike Jamb to C/L or Hole Prep On Frame

Top Rail Located

1 Raindrip	346 C 40"			PE
1 Door Bottom	315 CN 36"			PE
1 Threshold	2005 AT 36"			PE

weatherstripping

Heading #4.0 (Set #4.0) add auto opener; card reader on lobby side, push button on main gym side

1 Pair Doors **#101** add mag lock MAIN LOBBY 101 from MAIN RHRA
GYM 158

Opening Description: 2 - 3' 0" x 7' 0" x 1 3/4" x WD Type D-2-WD x HMF Type F-1-HM

Note: Wide stile required.

2 Continuous Hinge	HG-310 7'0"		630	MA
1 Exit Device	ED5470 x L955ET CT6D M55	LHR	630	CR
1 Exit Device	ED5470 x L955ET CT6D M55	RHR	630	CR
2 Core Only	CR8000 H3 MK VKC2		626	CR
2 Closer	DC6210 A4		689	CR
2 Protection Plate	K1050 10" x 35" CSK		US32D	RO
2 Door Silencer	608-RKW		GRAY	RO

Heading #5.0 (Set #5.0) add auto opener; card reader on lobby side, push button on B/N gym side

1 Pair Doors **#138A** add mag lock BALANCE & NEURO GYM RHRA
138 from MAIN LOBBY 101

Opening Description: 2 - 3' 0" x 7' 0" x 1 3/4" x WD Type D-2-WD x HMF Type F-1-HM

Note: Wide stile required.

2 Continuous Hinge	HG-305 7'0"		630	MA
1 Multi Point Lock	MP9800A LE X 45 X LN X 10 CT6D	RHR	626	CR
1 Multi Point Lock	MP9800A LE X 45 X LN X 10 CT6D	LHR	626	CR
2 Core Only	CR8000 H3 MK VKC2		626	CR
2 Closer	DC6210 A4		689	CR
2 Protection Plate	K1050 10" x 35" CSK		US32D	RO
Note: Push Side Mount				
2 Door Silencer	608-RKW		GRAY	RO

Heading #6.0 (Set #6.0) add mortise lockset ML2057 LWA CT6D

1 Single Door **#152** WAREHOUSE 150 from ELEC. LHR
152

Opening Description: 3' 0" x 7' 0" x 1 3/4" x WD Type D-1-WD x HMF Type F-1-HM

1 Continuous Hinge	HG-305 7'0"		630	MA
1 Exit Device	ED5200 x L957ET CT6D	LHR	630	CR
1 Core Only	CR8000 H3 MK VKC2		626	CR
1 Closer	DC6210 A4		689	CR
1 Smoke Seal	S88 BL 17'			PE

Heading #6.1 (Set #6.1)

1 Single Door **#124B** new hdw VEST 124 from HALL 120 LHR

Opening Description: 3' 0" x 7' 0" x 1 3/4" x WD Type D-1-WD Type EF-2-WD x 60Min

1 Continuous Hinge	HG-305 7'0"		630	MA
1 Exit Device	ED5200A x L955ET CT6D	LHR	630	CR
1 Core Only	CR8000 H3 MK VKC2		626	CR
1 Closer	DC6210 A4		689	CR
1 Smoke Seal	S88 BL 17'			PE

Heading #6.2 (Set #6.2) **card reader hardware from set #7 should be in this set**

1 Single Door #138C	new hdw	HALL 148 from BALANCE & NEURO GYM 138		LHR
Opening Description: 3' 0" x 7' 0" x 1 3/4" x WD Type D-1-WD x HMF Type F-1-HM				
1 Continuous Hinge	HG-305 7'0"		630	MA
1 Exit Device	ED5200 x L955ET CT6D		LHR 630	CR
1 Core Only	CR8000 H3 MK VKC2		626	CR
1 Closer	DC6210 A4		689	CR
1 Smoke Seal	S88 BL 17'			PE

Heading #6.3 (Set #6.3)

1 Single Door #235	new hdw	STAIRS 235 from HALL 233		RHR
Opening Description: 3' 0" x 7' 0" x 1 3/4" x WD Type D-1-WD x HMF Type F-1-HM x 60Min				
1 Continuous Hinge	HG-305 7'0"		630	MA
1 Exit Device	ED5200A x L910ET		RHR 630	CR
1 Closer	DC6210 A3		689	CR
1 Dome Stop	441		US26D	RO
1 Smoke Seal	S88 BL 17'			PE

Heading #6.3A (Set #6.3)

1 Single Door #254	new hdw	STAIRS 254 from HALL 247		RHR
Opening Description: 3' 0" x 7' 0" x 1 3/4" x WD Type D-1-WD x HMF Type EF-1-HM x 60 MIN.				
1 Continuous Hinge	HG-305 7'0"		630	MA
1 Exit Device	ED5200A x L910ET		RHR 630	CR
1 Closer	DC6210 A3		689	CR
1 Wall Stop	406		US26D	RO
1 Smoke Seal	S88 BL 17'			PE

North Oaks Rehabilitation And Sports Performance Center
304700

Heading #7.0 (Set #7.0) **card reader hardware from set #7 should be in set #6.2**

1 Single Door #138D MAIN GYM 158 from LHR
BALANCE & NEURO GYM
138

Opening Description: 3' 6" x 7' 0" x 1 3/4" x WD Type D-1-WD x HMF Type F-1-HM

Note: Doors are normally closed and secure. Presentation of valid credentials will allow entry by trim. Upon loss of power, doors will remain secure. Free egress at all times.

Coordinate voltage, operation and electrical characteristics with all related trades. Card reader, wiring and connections by security provider.

1 Continuous Hinge	HG-305 7'0" EL-8	RH	630	MA
1 Exit Device	ED5200 x L9905ET CT6D W048	LHR	630	CR
1 Core Only	CR8000 H3 MK VKC2		626	CR
1 Closer	DC6210 A4		689	CR
1 Protection Plate	K1050 10" x 40" CSK		US32D	RO
1 Wiring Harness	QC-C1500P			MC
Note: Wiring Harness from Power Transfer / Electric Hinge to Power Source Provided By Others				
1 Card Reader(By Others)	CARD READER BY SECURITY VENDOR			MISC
1 Power Supply	AQD1			SN
1 Wiring Harness	QC-C012P			MC
1 Switch	DPS-W-BK			SN
1 Smoke Seal	S88 BL 17'			PE

locktype?

Heading #7.1 (Set #7.1)

1 Single Door #136A new hdw STAIRS 136 from HALL 148 LHR
1 Single Door #136B new hdw STAIRS 136 from RHR
WAREHOUSE 150

Opening Description: 3' 0" x 7' 0" x 1 3/4" x WD Type D-1-WD x HMF Type F-1-HM x 60 MIN.

1 Continuous Hinge	HG-305 7'0" EL-8	RH	630	MA
1 Continuous Hinge	HG-305 7'0" EL-8	LH	630	MA
2 Exit Device	ED5200A x TH957ET CT6D M92 MELR		630	CR
2 Core Only	CR8000 H3 MK VKC2		626	CR
2 Closer	DC6210 A4		689	CR
2 Protection Plate	K1050 10" x 34" CSK		US32D	RO
Note: Push Side Mount				
2 Wiring Harness	QC-C1500P			MC
Note: Wiring Harness from Power Transfer / Electric Hinge to Power Source Provided By Others				
2 Card Reader(By Others)	CARD READER BY SECURITY VENDOR			MISC
2 Power Supply	AQD1			SN
2 Wiring Harness	QC-C012P			MC
2 Switch	DPS-W-BK			SN
2 Smoke Seal	S88 BL 17'			PE

Heading #7.1A (Set #7.1)

1 Single Door #156	new hdw	VEST 124 from STAIR 156		RHR
Opening Description: 3' 0" x 7' 0" x 1 3/4" x WD Type D-1-WD x HMF Type EF-1-HM x 60 MIN.				
1 Continuous Hinge	HG-305 7'0" EL-8		LH 630	MA
1 Exit Device	ED5200A x TH957ET CT6D M92 MELR		630	CR
1 Core Only	CR8000 H3 MK VKC2		626	CR
1 Closer	DC6210 A4		689	CR
1 Protection Plate	K1050 10" x 34" CSK		US32D	RO
Note: Push Side Mount				
1 Wiring Harness	QC-C1500P			MC
Note: Wiring Harness from Power Transfer / Electric Hinge to Power Source Provided By Others				
1 Card Reader(By Others)	CARD READER BY SECURITY VENDOR			MISC
1 Switch	DPS-M-BK			SN
Note: 3/4" Hole Prep - Located 6" From Strike Jamb to C/L or Hole Prep On Frame				
Top Rail Located				
1 Power Supply	AQD1			SN
1 Wiring Harness	QC-C012P			MC
1 Smoke Seal	S88 BL 17'			PE

Heading #7.2 (Set #7.0)

1 Single Door #144	new hdw	HALL 144 from MAIN GYM		RHR
		158		
1 Single Door #233		HALL 233 from PEDS GYM		LHR
		210		
Opening Description: 3' 0" x 7' 0" x 1 3/4" x WD Type D-1-WD x HMF Type F-1-HM				
1 Continuous Hinge	HG-305 7'0" EL-8		RH 630	MA
1 Continuous Hinge	HG-305 7'0" EL-8		LH 630	MA
1 Exit Device	ED5200 x L9905ET CT6D		LHR 630	CR
1 Exit Device	ED5200 x L9905ET CT6D		RHR 630	CR
2 Core Only	CR8000 H3 MK VKC2		626	CR
2 Closer	DC6200 A4		689	CR
2 Protection Plate	K1050 10" x 34" CSK		US32D	RO
Note: Push Side Mount				
2 Wiring Harness	QC-C1500P			MC
Note: Wiring Harness from Power Transfer / Electric Hinge to Power Source Provided By Others				
2 Card Reader(By Others)	CARD READER BY SECURITY VENDOR			MISC
2 Power Supply	AQD1			SN
2 Wiring Harness	QC-C012P			MC
2 Switch	DPS-W-BK			SN
2 Smoke Seal	S88 BL 17'			PE

Heading #8.0 (Set #8.0) add auto opener; push button on either side

1 Single Door #201 LOBBY 201 from PEDS LHR
WAITING 206

Opening Description: 3' 8 1/4" x 6' 10 3/4" Type D-5-AL Type F-3-AL

Note: Confirm hardware compatability with aluminum door manufacturer. Wide stile required.

1 Pivot Set	195 3/4" OFFSET	RH	626	RX
1 Intermediate Pivot	M19	RH	626	RX
1 Mortise Lockset	ML2055 LWA CT6D	LHR	626	CR
1 Core Only	CR8000 H3 MK VKC2		626	CR
1 Closer	DC6210 A4		689	CR
1 Smoke Seal	S88 BL 18'			PE

Heading #8.1 (Set #8.0) add card reader and required hardware

1 Single Door #133 MAIN LOBBY 101 to LH
SCHEDULER BULLPEN 133

Opening Description: 3' 6" x 6' 10 3/4" Type D-5-AL Type F-3-AL

Note: A4 closer arm installs on push side of door. Closer will be on lobby 101 side of door. verify closer arm to be used.

Confirm hardware compatability with aluminum door manufacturer. Wide stile required.

1 Pivot Set	195 3/4" OFFSET	LH	626	RX
1 Intermediate Pivot	M19	LH	626	RX
1 Mortise Lockset	ML2055 LWA CT6D	LH	626	CR
1 Core Only	CR8000 H3 MK VKC2		626	CR
1 Closer	DC6210 A4		689	CR
1 Smoke Seal	S88 BL 18'			PE

Heading #9.0 (Set #9.0)

1 Single Door #131	MAIN LOBBY 101 to SCHEDULER 131	RH
1 Single Door #132	MAIN LOBBY 101 to SCHEDULE/REGISTRATION SUPERVISOR 132	LH
1 Single Door #211	PEDS GYM 210 to THERAPIST OFFICE 211	LH



add card reader and
required hardware
to #211

Opening Description: 3' 6" x 6' 10 3/4" Type D-5-AL Type F-3-AL

Note: Confirm hardware compatibility with aluminum door manufacturer. Wide stile required.

2 Pivot Set	195 3/4" OFFSET	LH	626	RX
1 Pivot Set	195 3/4" OFFSET	RH	626	RX
2 Intermediate Pivot	M19	LH	626	RX
1 Intermediate Pivot	M19	RH	626	RX
2 Mortise Lockset	ML2054 LWA CT6D M34	LH	630	CR
1 Mortise Lockset	ML2054 LWA CT6D M34	RH	630	CR
3 Core Only	CR8000 H3 MK VKC2		626	CR
3 Closer	DC6200 A10		689	CR
3 Wall Stop	406		US26D	RO
3 Smoke Seal	S88 BL 18'			PE

Heading #10.0 (Set #10.0)

1 Single Door #240	HALL 230 to HALL 240	LH
--------------------	----------------------	----

Opening Description: 3' 0" x 7' 0" x 1 3/4" x WD Type D-1-WD x HMF Type F-1-HM

Note: Doors are normally closed and secure. Presentation of valid credentials will allow entry by pull. Upon loss of power, doors will remain secure. Free egress at all times.

Coordinate voltage, operation and electrical characteristics with all related trades. Card reader, wiring and connections by security provider.

3 Hinges	TA2714 4 1/2 X 4 1/2		26D	MC
1 Mortise Lockset	ML2057 LWA CT6D	LH	630	CR
1 Core Only	CR8000 H3 MK VKC2		626	CR
1 Electric Strike	1006CLB		630	HS
1 Closer	DC6200 A10		689	CR
1 Protection Plate	K1050 10" x 34" CSK		US32D	RO
Note: Push Side Mount				
1 Wall Stop	406		US26D	RO
1 Wiring Harness	QC-C1500P			MC
Note: Wiring Harness from Power Transfer / Electric Hinge to Power Source Provided By Others				
1 Card Reader(By Others)	CARD READER BY SECURITY VENDOR			MISC
1 Power Supply	AQD1			SN
1 Switch	DPS-W-BK			SN
1 Smoke Seal	S88 BL 17'			PE

Heading #10.0A (Set #10.0)

1 Single Door #126	new hdw	VEST 124 to HSKG 126	RH
1 Single Door #157A		HALL 148 to FILE STORAGE 157	RH

Opening Description: 3' 0" x 7' 0" x 1 3/4" x WD Type D-1-WD x HMF Type EF-1-HM x 60 MIN. (126)
3' 0" x 7' 0" x 1 3/4" x WD Type D-1-WD x HMF Type F-1-HM x SMOKE (157A)

6 Hinges	TA2714 4 1/2 X 4 1/2		26D	MC
2 Mortise Lockset	ML2057 LWA CT6D	RH	630	CR
2 Core Only	CR8000 H3 MK VKC2		626	CR
2 Electric Strike	1006CLB		630	HS
2 Closer	DC6200 A10		689	CR
2 Protection Plate	K1050 10" x 34" CSK		US32D	RO
Note: Push Side Mount				
2 Wall Stop	406		US26D	RO
2 Wiring Harness	QC-C1500P			MC
Note: Wiring Harness from Power Transfer / Electric Hinge to Power Source Provided By Others				
2 Card Reader(By Others)	CARD READER BY SECURITY VENDOR			MISC
2 Power Supply	AQD1			SN
2 Switch	DPS-W-BK			SN
2 Smoke Seal	S88 BL 17'			PE

Heading #10.1 (Set #10.1)

1 Single Door #125		HALL 120 from DATA 125	LHR
--------------------	--	------------------------	-----

Opening Description: 3' 0" x 7' 0" x 1 3/4" x WD Type D-1-WD x HMF Type F-1-HM

Note: Doors are normally closed and secure. Presentation of valid credentials will allow entry by pull. Upon loss of power, doors will remain secure. Free egress at all times.

Coordinate voltage, operation and electrical characteristics with all related trades. Card reader, wiring and connections by security provider.

3 Hinges	TA2714 4 1/2 X 4 1/2 NRP		26D	MC
1 Mortise Lockset	ML2057 LWA CT6D	LHR	630	CR
1 Core Only	CR8000 H3 MK VKC2		626	CR
1 Electric Strike	1006CLB		630	HS
1 Closer	DC6210 A3		689	CR
1 Protection Plate	K1050 10" x 34" CSK		US32D	RO
1 Dome Stop	441		US26D	RO
1 Wiring Harness	QC-C1500P			MC
Note: Wiring Harness from Power Transfer / Electric Hinge to Power Source Provided By Others				
1 Card Reader(By Others)	CARD READER BY SECURITY VENDOR			MISC
1 Power Supply	AQD1			SN
1 Switch	DPS-W-BK			SN
1 Smoke Seal	S88 BL 18'			PE

Heading #10.2A (Set #10.0)

1 Single Door #143 BALANCE & NEURO GYM
138 from EQUIPMENT 143 LHR

Opening Description: 3' 0" x 7' 0" x 1 3/4" x WD Type D-1-WD x HMF Type F-1-HM x SMOKE

Note: Doors are normally closed and secure. Presentation of valid credentials will allow entry by pull. Upon loss of power, doors will remain secure. Free egress at all times.

Coordinate voltage, operation and electrical characteristics with all related trades. Card reader, wiring and connections by security provider.

3 Hinges	TA2714 4 1/2 X 4 1/2 NRP		26D	MC
1 Mortise Lockset	ML2057 LWA CT6D	LHR	630	CR
1 Core Only	CR8000 H3 MK VKC2		626	CR
1 Electric Strike	1006CLB		630	HS
1 Closer	DC6210 A3		689	CR
1 Protection Plate	K1050 10" x 34" CSK		US32D	RO
Note: Push Side Mount				
1 Wall Stop	406		US26D	RO
1 Wiring Harness	QC-C1500P			MC
Note: Wiring Harness from Power Transfer / Electric Hinge to Power Source Provided By Others				
1 Card Reader(By Others)	CARD READER BY SECURITY VENDOR			MISC
1 Power Supply	AQD1			SN
1 Switch	DPS-W-BK			SN
1 Smoke Seal	S88 BL 17'			PE

Heading #11.0A (Set #11.0)

1 Single Door #149 HALL 148 to HSK'G 149 LH

Opening Description: 3' 0" x 7' 0" x 1 3/4" x WD Type D-1-WD x HMF Type F-1-HM x 60 MIN.

Note: Doors are normally closed and secure. Presentation of valid credentials will allow entry by pull. Upon loss of power, doors will remain secure. Free egress at all times.

Coordinate voltage, operation and electrical characteristics with all related trades. Card reader, wiring and connections by security provider.

1 Continuous Hinge	HG-305 7'0"		630	MA
1 Mortise Lockset	ML2057 LWA CT6D	LH	630	CR
1 Core Only	CR8000 H3 MK VKC2		626	CR
1 Electric Strike	1006CLB		630	HS
1 Closer	DC6200 A10		689	CR
1 Protection Plate	K1050 10" x 34" CSK		US32D	RO
Note: Push Side Mount				
1 Wall Stop	406		US26D	RO
1 Wiring Harness	QC-C1500P			MC
Note: Wiring Harness from Power Transfer / Electric Hinge to Power Source Provided By Others				
1 Card Reader(By Others)	CARD READER BY SECURITY VENDOR			MISC
1 Power Supply	AQD1			SN
1 Switch	DPS-W-BK			SN
1 Smoke Seal	S88 BL 17'			PE

Heading #12.0 (Set #12.0)

1 Single Door #112

MAIN GYM 158 from
EQUIPMENT 112

LHR

Opening Description: 3' 6" x 7' 0" x 1 3/4" x WD Type D-1-WD x HMF Type F-1-HM x SMOKE

Note: Doors are normally closed and secure. Presentation of valid credentials will allow entry by pull. Upon loss of power, doors will remain secure. Free egress at all times.

Coordinate voltage, operation and electrical characteristics with all related trades. Card reader, wiring and connections by security provider.

3 Hinges	T4A3786 5 X 4 1/2 NRP		26D	MC
1 Mortise Lockset	ML2057 LWA CT6D	LHR	630	CR
1 Core Only	CR8000 H3 MK VKC2		626	CR
1 Electric Strike	1006CLB		630	HS
1 Closer	DC6210 A3		689	CR
1 Protection Plate	K1050 10" x 40" CSK		US32D	RO
Note: Push Side Mount				
1 Wall Stop	406		US26D	RO
1 Wiring Harness	QC-C1500P			MC
Note: Wiring Harness from Power Transfer / Electric Hinge to Power Source Provided By Others				
1 Card Reader(By Others)	CARD READER BY SECURITY VENDOR			MISC
1 Power Supply	AQD1			SN
1 Switch	DPS-W-BK			SN
1 Smoke Seal	S88 BL 18'			PE

Heading #13.0 (Set #13.0)

1 Single Door #110A	MAIN GYM 158 to DIRTY LINEN 110A	LH
1 Single Door #110B	BALANCE & NEURO GYM 138 to DIRTY LINEN 110A	RH
1 Single Door #111A	MAIN GYM 158 to CLEAN LINEN 111	RH
1 Single Door #111B	BALANCE & NEURO GYM 138 to CLEAN LINEN 111	LH

Opening Description: 3' 6" x 7' 0" x 1 3/4" x WD Type D-1-WD x HMF Type F-1-HM

Note: Doors are normally closed and secure. Presentation of valid credentials will allow entry by pull. Upon loss of power, doors will remain secure. Free egress at all times.

Coordinate voltage, operation and electrical characteristics with all related trades. Card reader, wiring and connections by security provider.

4 Continuous Hinge	HG-305 7'0"	630	MA
2 Mortise Lockset	ML2057 LWA CT6D	LH 630	CR
2 Mortise Lockset	ML2057 LWA CT6D	RH 630	CR
4 Core Only	CR8000 H3 MK VKC2	626	CR
4 Electric Strike	1006CLB	630	HS
4 Closer	DC6200 A10	689	CR
4 Protection Plate	K1050 10" x 40" CSK	US32D	RO
Note: Push Side Mount			
4 Wall Stop	406	US26D	RO
4 Wiring Harness	QC-C1500P		MC
Note: Wiring Harness from Power Transfer / Electric Hinge to Power Source Provided By Others			
4 Card Reader(By Others)	CARD READER BY SECURITY VENDOR		MISC
4 Power Supply	AQD1		SN
4 Switch	DPS-W-BK		SN
4 Smoke Seal	S88 BL 18'		PE

Heading #14.0 (Set #14.0) **revise to MLC lockset; ML2055 LWA CT6D**

1 Single Door #209	PEDS GYM 210 from EQUIP CLEAN 209	RHR
1 Single Door #219	PEDS GYM 210 from CLEAN LINEN 219	RHR
1 Single Door #220	PEDS GYM 210 from DIRTY LINEN 220	LHR

Opening Description: 3' 6" x 7' 0" x 1 3/4" x WD Type D-1-WD x HMF Type F-1-HM (209, 220)
3' 6" x 7' 0" x 1 3/4" x WD Type D-6-WD x HMF Type F-1-HM (219)

3 Continuous Hinge	HG-305 7'0"	630	MA
1 Mortise Lockset	ML2057 LWA CT6D	LHR 630	CR
2 Mortise Lockset	ML2057 LWA CT6D	RHR 630	CR
3 Core Only	CR8000 H3 MK VKC2	626	CR
3 Closer	DC6210 A3	689	CR
3 Protection Plate	K1050 10" x 40" CSK	US32D	RO
Note: Push Side Mount			
3 Smoke Seal	S88 BL 18'		PE

Heading #15.1 (Set #15.0)

1 Single Door #205		HALL 202 to MECH 205		LH
Opening Description: 3' 6" x 7' 0" x 1 3/4" x WD Type D-1-WD x HMF Type F-1-HM				
3 Hinges	T4A3786 5 X 4 1/2		26D	MC
1 Mortise Lockset	ML2057 LWA CT6D	LH	630	CR
1 Core Only	CR8000 H3 MK VKC2		626	CR
1 Closer	DC6200 A10		689	CR
1 Protection Plate	K1050 10" x 40" CSK		US32D	RO
1 Wall Stop	406		US26D	RO
3 Door Silencer	608-RKW		GRAY	RO

remove; add smoke seal

Heading #16.0 (Set #16.0)

1 Single Door #204		HALL 202 to HSK'G 204		LH
1 Single Door #248		HALL 248 to MECH 248		LH
Opening Description: 3' 0" x 7' 0" x 1 3/4" x WD Type D-1-WD x HMF Type F-1-HM				
6 Hinges	TA2714 4 1/2 X 4 1/2		26D	MC
2 Mortise Lockset	ML2057 LWA CT6D	LH	630	CR
2 Core Only	CR8000 H3 MK VKC2		626	CR
2 Closer	DC6200 A10		689	CR
2 Protection Plate	K1050 10" x 34" CSK		US32D	RO
2 Wall Stop	406		US26D	RO
2 Smoke Seal	S88 BL 17'			PE

need a card reader?

Heading #16.0A (Set #16.0)

1 Single Door #122		HALL 120 to MECH 122		RH
Opening Description: 3' 0" x 7' 0" x 1 3/4" x WD Type D-1-WD x HMF Type F-1-HM				
3 Hinges	TA2714 4 1/2 X 4 1/2		26D	MC
1 Mortise Lockset	ML2057 LWA CT6D	RH	630	CR
1 Core Only	CR8000 H3 MK VKC2		626	CR
1 Closer	DC6200 A10		689	CR
1 Protection Plate	K1050 10" x 34" CSK		US32D	RO
1 Dome Stop	441		US26D	RO
1 Smoke Seal	S88 BL 17'			PE

Heading #16.1 (Set #16.0)

need card reader

1 Single Door #142		BALANCE & NEURO GYM		RHR
		138 from MECH 142		
1 Single Door #222		HALL 229 to DATA 222		LH
1 Single Door #234	new hdw	HALL 233 from MECH 234		LHR
Opening Description: 3' 0" x 7' 0" x 1 3/4" x WD Type D-1-WD x HMF Type F-1-HM				
9 Hinges	TA2714 4 1/2 X 4 1/2 NRP		26D	MC
1 Mortise Lockset	ML2057 LWA CT6D	LH	630	CR
1 Mortise Lockset	ML2057 LWA CT6D	LHR	630	CR
1 Mortise Lockset	ML2057 LWA CT6D	RHR	630	CR
3 Core Only	CR8000 H3 MK VKC2		626	CR
3 Closer	DC6210 A3		689	CR
3 Protection Plate	K1050 10" x 34" CSK		US32D	RO
3 Wall Stop	406		US26D	RO
3 Smoke Seal	S88 BL 17'			PE

Heading #16.1A (Set #16.0)

1 Single Door #253	new hdw	HALL 247 from SPRINKLER 253		RHR
Opening Description: 3' 0" x 7' 0" x 1 3/4" x WD Type D-1-WD x HMF Type F-1-HM				
3 Hinges	TA2714 4 1/2 X 4 1/2 NRP		26D	MC
1 Mortise Lockset	ML2057 LWA CT6D	RHR	630	CR
1 Core Only	CR8000 H3 MK VKC2		626	CR
1 Closer	DC6210 A3		689	CR
1 Protection Plate	K1050 10" x 34" CSK		US32D	RO
1 Dome Stop	441		US26D	RO
1 Smoke Seal	S88 BL 17'			PE

Heading #16.1B (Set #16.0)

1 Single Door #218		PEDS GYM 210 from MECH 218		RHR
Opening Description: 3' 0" x 7' 0" x 1 3/4" x WD Type D-1-WD x HMF Type F-1-HM x 60Min				
3 Hinges	TA2714 4 1/2 X 4 1/2 NRP		26D	MC
1 Mortise Lockset	ML2057 LWA CT6D	RHR	630	CR
1 Core Only	CR8000 H3 MK VKC2		626	CR
1 Closer	DC6210 A3		689	CR
1 Protection Plate	K1050 10" x 34" CSK		US32D	RO
1 Wall Stop	406		US26D	RO
1 Smoke Seal	S88 BL 17'			PE

Heading #16.1C (Set #16.1)

1 Single Door #127	new hdw	VEST 124 from SPRK 127		LHR
Opening Description: 3' 0" x 7' 0" x 1 3/4" x WD Type D-1-WD x HMF Type EF-1-HM				
3 Hinges	TA2714 4 1/2 X 4 1/2 NRP		26D	MC
1 Mortise Lockset	ML2057 LWA CT6D	LHR	630	CR
1 Core Only	CR8000 H3 MK VKC2		626	CR
1 Closer	DC6210 A4		689	CR
1 Protection Plate	K1050 10" x 34" CSK		US32D	RO
1 Dome Stop	441		US26D	RO
1 Smoke Seal	S88 BL 17'			PE

Heading #17.0 (Set #17.0) revise to MLC lockset; ML2055 LWA CT6D

1 Single Door #239		HALL 247 to STORAGE 239		RH
Opening Description: 3' 0" x 7' 0" x 1 3/4" x WD Type D-1-WD x HMF Type F-1-HM				
3 Hinges	TA2714 4 1/2 X 4 1/2		26D	MC
1 Mortise Lockset	ML2057 LWA CT6D	RH	630	CR
1 Core Only	CR8000 H3 MK VKC2		626	CR
1 Wall Stop	406		US26D	RO
3 Door Silencer	608-RKW		GRAY	RO

Heading #18.0 (Set #18.0) revise to MLC lockset; ML2055 LWA CT6D

1 Single Door #208		PEDS GYM 210 to EQUIPMENT 208		LH
Opening Description: 3' 0" x 7' 0" x 1 3/4" x WD Type D-1-WD x HMF Type F-1-HM x SMOKE				
3 Hinges	T4A3786 4 1/2 X 4 1/2		26D	MC
1 Mortise Lockset	ML2057 LWA CT6D	LH	630	CR
1 Core Only	CR8000 H3 MK VKC2		626	CR
1 Closer	DC6200 A10		689	CR
1 Protection Plate	K1050 10" x 34" CSK		US32D	RO
1 Wall Stop	406		US26D	RO
1 Smoke Seal	S88 BL 17'			PE

Heading #18.0A (Set #18.0) revise to MLC lockset; ML2055 LWA CT6D

1 Single Door #221		PEDS GYM 210 to EQUIPMENT 221		LH
Opening Description: 3' 6" x 7' 0" x 1 3/4" x WD Type D-1-WD x HMF Type F-1-HM x SMOKE				
3 Hinges	T4A3786 4 1/2 X 4 1/2		26D	MC
1 Mortise Lockset	ML2057 LWA CT6D	LH	630	CR
1 Core Only	CR8000 H3 MK VKC2		626	CR
1 Closer	DC6200 A10		689	CR
1 Protection Plate	K1050 10" x 40" CSK		US32D	RO
Note: Push Side Mount				
1 Wall Stop	406		US26D	RO
1 Smoke Seal	S88 BL 18'			PE

Heading #18.1 (Set #18.0) **revise to PVL lockset; ML2030 LWA**

1 Single Door #226 PELVIC HEALTH WAITING LH
223 to PELVIC HEALTH TX
226

Opening Description: 3' 6" x 7' 0" x 1 3/4" x WD Type D-1-WD x HMF Type F-1-HM

3 Hinges	T4A3786 5 X 4 1/2		26D	MC
1 Mortise Lockset	ML2057 LWA CT6D	LH	630	CR
1 Core Only	CR8000 H3 MK VKC2		626	CR
1 Closer	DC6200 A10		689	CR
1 Protection Plate	K1050 10" x 40" CSK		US32D	RO
Note: Push Side Mount				
1 Wall Stop	406		US26D	RO
3 Door Silencer	608-RKW		GRAY	RO

Heading #19.0 (Set #19.0) **revise to Passage lockset; ML2010 LWA**

1 Single Door #217 PEDS GYM 210 to PEDS LH
KITCHEN 217

Opening Description: 3' 6" x 7' 0" x 1 3/4" x WD Type D-1-WD x HMF Type F-1-HM

3 Hinges	T4A3786 5 X 4 1/2		26D	MC
1 Mortise Lockset	ML2055 LWA CT6D	LH	626	CR
1 Core Only	CR8000 H3 MK VKC2		626	CR
1 Closer	DC6200 A10		689	CR
1 Protection Plate	K1050 10" x 40" CSK		US32D	RO
Note: Push Side Mount				
1 Wall Stop	406		US26D	RO
3 Door Silencer	608-RKW		GRAY	RO

need a card reader? auto opener?

Heading #19.0A (Set #19.0)

1 Single Door #206 PEDS WAITING 206 from LHR
PEDS GYM 210

Opening Description: 3' 6" x 7' 0" x 1 3/4" x WD Type D-1-WD x HMF Type F-1-HM

3 Hinges	T4A3786 5 X 4 1/2		26D	MC
1 Mortise Lockset	ML2055 LWA CT6D	LHR	626	CR
1 Core Only	CR8000 H3 MK VKC2		626	CR
1 Closer	DC6210 A3		689	CR
1 Protection Plate	K1050 10" x 40" CSK		US32D	RO
Note: Push Side Mount				
1 Wall Stop	406		US26D	RO
3 Door Silencer	608-RKW		GRAY	RO

Heading #20.0 (Set #20.0)

1 Single Door #108	MAIN GYM 158 to HOT PACK/COLD PACK 108			LH
1 Single Door #229 revise #229 to MLC lockset; ML2055 LWA CT6D	LOBBY 201 to AUDIO WAITING 227			LH
Opening Description: 3' 6" x 7' 0" x 1 3/4" x WD Type D-1-WD x HMF Type F-1-HM (108) 3' 6" x 7' 0" x 1 3/4" x WD Type D-2-WD x HMF Type F-1-HM (229)				
6 Hinges	T4A3786 5 X 4 1/2		26D	MC
2 Passage Set	ML2010 LWA	LH	630	CR
2 Closer	DC6200 A10		689	CR
2 Protection Plate	K1050 10" x 40" CSK		US32D	RO
Note: Push Side Mount				
2 Wall Stop	406		US26D	RO
6 Door Silencer	608-RKW		GRAY	RO

Heading #20.1 (Set #20.0) revise to PVL lockset; ML2030 LWA

1 Single Door #121	HALL 120 from CALL 121			RHR
Opening Description: 3' 6" x 7' 0" x 1 3/4" x WD Type D-1-WD x HMF Type F-1-HM				
3 Hinges	T4A3786 5 X 4 1/2 NRP		26D	MC
1 Passage Set	ML2010 LWA	RHR	630	CR
1 Closer	DC6210 A3		689	CR
1 Protection Plate	K1050 10" x 40" CSK		US32D	RO
Note: Push Side Mount				
1 Dome Stop	441		US26D	RO
3 Door Silencer	608-RKW		GRAY	RO

Heading #21.0 (Set #21.0)

1 Single Door #113	THERAPIST TOUCHDOWN 107 to TREATMENT ROOM 113	RH
1 Single Door #114	THERAPIST TOUCHDOWN 107 to TREATMENT ROOM 114	RH
1 Single Door #115	THERAPIST TOUCHDOWN 107 to TREATMENT ROOM 115	LH
1 Single Door #116	THERAPIST TOUCHDOWN 107 to TREATMENT ROOM 116	RH
1 Single Door #117	THERAPIST TOUCHDOWN 107 to TRACTION ROOM 117	LH
1 Single Door #118	THERAPIST TOUCHDOWN 107 to TREATMENT ROOM 118	LH
1 Single Door #134	BALANCE & NEURO GYM 138 to SPEECH THERAPY 134	LH
1 Single Door #135	BALANCE & NEURO GYM 138 to SPEECH THERAPY 135	RH
1 Single Door #137	BALANCE & NEURO GYM 138 to SPEECH THERAPY 137	LH
1 Single Door #139	BALANCE & NEURO GYM 138 to B/N TREATMENT 139	LH
1 Single Door #140	BALANCE & NEURO GYM 138 to B/N TREATMENT 140	RH
1 Single Door #212	PEDS GYM 210 to PEDS TREATMENT 212	LH
1 Single Door #213	PEDS GYM 210 to PEDS TREATMENT 213	RH
1 Single Door #214	PEDS GYM 210 to PEDS TREATMENT 214	LH
1 Single Door #215	PEDS GYM 210 to PEDS TREATMENT 215	RH
1 Single Door #216	PEDS GYM 210 to PEDS TREATMENT 216	LH
1 Single Door #224	revise #224 to PVL lockset; ML2030 LWA PELVIC HEALTH WAITING 223 to PELVIC HEALTH TX 224	RH
1 Single Door #228	revise #228 to MLC lockset; ML2055 LWA CT6D AUDIO WAITING 227 to HEARING AID 228	RH
1 Single Door #231	revise #231 to MLC lockset; ML2055 LWA CT6D HALL 230 to AUDIO THERAPY 231	LH
1 Single Door #232	revise #232 to MLC lockset; ML2055 LWA CT6D HALL 230 to AUDIO BOOTH 232	LH

Opening Description: 3' 6" x 7' 0" x 1 3/4" x WD Type D-1-WD x HMF Type F-1-HM (113, 114, 115, 116, 117, 118, 134, 135, 137, 139, 140, 224, 228, 231, 232)

Heading #21.0 (Set #21.0)

3' 6" x 7' 0" x 1 3/4" x WD Type D-6-WD x HMF Type F-1-HM (212, 213, 214, 215, 216)

60 Hinges	T4A3786 5 X 4 1/2		26D	MC
11 Passage Set	ML2010 LWA	LH	630	CR
9 Passage Set	ML2010 LWA	RH	630	CR
20 Protection Plate	K1050 10" x 40" CSK		US32D	RO
Note: Push Side Mount				
20 Wall Stop	406		US26D	RO
60 Door Silencer	608-RKW		GRAY	RO

Heading #22.0 (Set #22.0)

1 Single Door #145		HALL 144 to STAFF RR 145		RH
1 Single Door #146		HALL 144 to STAFF RR 146		RH
1 Single Door #251		HALL 247 to STAFF RR 251		RH
1 Single Door #252		HALL 247 to STAFF RR 252		RH

Opening Description: 3' 0" x 7' 0" x 1 3/4" x WD Type D-1-WD x HMF Type F-1-HM (145, 146)
3' 6" x 7' 0" x 1 3/4" x WD Type D-1-WD x HMF Type F-1-HM (251, 252)

12 Hinges	T4A3786 4 1/2 X 4 1/2		26D	MC
4 Privacy Set	ML2030 LWA	RH	630	CR
4 Closer	DC6200 A10		689	CR
4 Protection Plate	K1050 10" x 34" CSK		US32D	RO
4 Wall Stop	406		US26D	RO
4 Smoke Seal	S88 BL 17'			PE

Heading #22.1 (Set #22.0)

1 Single Door #109		MAIN GYM 158 to RR 109		RH
1 Single Door #203		HALL 202 to RR 203		RH
1 Single Door #225		PELVIC HEALTH TX 224 to P.H. RR 225		LH
1 Single Door #225B		PELVIC HEALTH TX 226 to P.H. RR 225		RH

Opening Description: 3' 6" x 7' 0" x 1 3/4" x WD Type D-1-WD x HMF Type F-1-HM

12 Hinges	T4A3786 5 X 4 1/2		26D	MC
3 Privacy Set	ML2030 LWA	RH	630	CR
1 Privacy Set	ML2030 LWA	LH	630	CR
4 Closer	DC6200 A10		689	CR
4 Protection Plate	K1050 10" x 40" CSK		US32D	RO
Note: Push Side Mount				
4 Wall Stop	406		US26D	RO
4 Smoke Seal	S88 BL 18'			PE

Heading #22.2 (Set #22.0)

1 Single Door #206B		PEDS WAITING 206 from RR 206B		RHR
Opening Description: 3' 6" x 7' 0" x 1 3/4" x WD Type D-1-WD x HMF Type F-1-HM				
3 Hinges	T4A3786 5 X 4 1/2		26D	MC
1 Privacy Set	ML2030 LWA	RHR	630	CR
1 Closer	DC6210 A3		689	CR
1 Protection Plate	K1050 10" x 40" CSK		US32D	RO
Note: Push Side Mount				
1 Wall Stop	406		US26D	RO
1 Smoke Seal	S88 BL 18'			PE

Heading #23.0 (Set #23.0)

1 Single Door #207		PEDS GYM 210 from PEDS RR 207		LHR
Opening Description: 3' 6" x 7' 0" x 1 3/4" x WD Type D-1-WD x HMF Type F-1-HM				
3 Hinges	T4A3786 4 1/2 X 4 1/2		26D	MC
1 Privacy Set	ML2030 LWA	LHR	630	CR
1 Closer	DC6210 A4		689	CR
1 Protection Plate	K1050 10" x 40" CSK		US32D	RO
Note: Push Side Mount				
1 Smoke Seal	S88 BL 18'			PE

Heading #23.2 (Set #23.0)

1 Single Door #141		BALANCE & NEURO GYM 138 from B/N RR 141		LHR
Opening Description: 3' 6" x 7' 0" x 1 3/4" x WD Type D-1-WD x HMF Type F-1-HM				
3 Hinges	T4A3786 5 X 4 1/2		26D	MC
1 Privacy Set	ML2030 LWA	LHR	630	CR
1 Closer	DC6210 A4		689	CR
1 Protection Plate	K1050 10" x 40" CSK		US32D	RO
Note: Push Side Mount				
1 Smoke Seal	S88 BL 18'			PE

Heading #24.0 (Set #24.0)

1 Single Door #236		HALL 229 to MEETING ROOM SPORTS MED 236		LH
Opening Description: 3' 6" x 7' 0" x 1 3/4" x WD Type D-1-WD x HMF Type F-1-HM				
3 Hinges	T4A3786 5 X 4 1/2		26D	MC
1 Mortise Lockset	ML2054 LWA CT6D M34	LH	630	CR
1 Wall Stop	406		US26D	RO
3 Door Silencer	608-RKW		GRAY	RO

Heading #25.0 (Set #25.0)

1 Single Door #102	MAIN GYM 158 to CHECK- IN/CHECK-OUT 102	LH
1 Single Door #241	HALL 240 to MANAGER 241	LH
1 Single Door #242	HALL 245 to MANAGER 242	RH
1 Single Door #243	HALL 245 to SUPERVISOR 243	LH
1 Single Door #249	HALL 245 to PROG. ASSISTANT 249	LH
1 Single Door #250	HALL 245 to DIRECTOR 250	LH

Opening Description: 3' 0" x 7' 0" x 1 3/4" x HMD Type D-1-WD x HMF Type F-1-HM (102)
3' 0" x 7' 0" x 1 3/4" x WD Type D-1-WD x HMF Type F-1-HM (241, 242, 243, 249,
250)

18 Hinges	TA2714 4 1/2 X 4 1/2	26D	MC
5 Mortise Lockset	ML2054 LWA CT6D M34	LH 630	CR
1 Mortise Lockset	ML2054 LWA CT6D M34	RH 630	CR
6 Wall Stop	406	US26D	RO
18 Door Silencer	608-RKW	GRAY	RO

Heading #26.0 (Set #26.0)

1 Single Door #237	revise #237 to MLO lockset; ML2054 LWA CT6D M34	HALL 245 to CONFERENCE 237	RH
1 Single Door #238		HALL 245 to BREAKROOM 238	RH
1 Single Door #244		HALL 245 to COPY/PRINT 244	RH

Opening Description: 3' 0" x 7' 0" x 1 3/4" x WD Type D-1-WD x HMF Type F-1-HM

9 Hinges	TA2714 4 1/2 X 4 1/2	26D	MC
3 Passage Set	ML2010 LWA	RH 630	CR
3 Wall Stop	406	US26D	RO
9 Door Silencer	608-RKW	GRAY	RO

Heading #27.0 (Set #27.0)

1 Single Door #104		VEST 119 to MENS RR 104	LH
1 Single Door #105		VEST 119 to FEMALE RR 105	RH

Opening Description: 3' 6" x 7' 0" x 1 3/4" x WD Type D-1-WD x HMF Type F-1-HM

6 Hinges	T4A3786 5 X 4 1/2	26D	MC
2 Push Plate	70F 8 X 16	US32D	RO
2 Pull Plate	BF 107 X 70C	US32D	RO
2 Closer	DC6200 A10	689	CR
2 Protection Plate	K1050 10" x 40" CSK	US32D	RO
Note: Push Side Mount			
2 Wall Stop	406	US26D	RO
6 Door Silencer	608-RKW	GRAY	RO

Heading #28.0 (Set #28.0)

1 Other Door #150C		LOADING DOCK 153 WAREHOUSE 150		
1 Other Door #157B		LOADING DOCK 153 FILE STORAGE 157		
Opening Description: Type ED-5-OHD Type OHD-OHD (157B) 12' 0" x 10' 0" Type ED-5-OHD Type OHD-OHD (150C)				
2 Core Only	CR8000 H3 MK VKC2		626	CR
2 Balance of Hardware(By Others)	BALANCE OF HARDWARE BY DOOR MFG			MISC

Heading #29.0 (Set #29.0)

1 Other Door #150A	new hdw	EXTERIOR WAREHOUSE 150		
Opening Description: 8' 0" x 8' 0" Type ED-5-OHD Type OHD-OHD				
1 Reused(By Others)	EXISTING HARDWARE TO BE REUSED			MISC

Heading #29.1 (Set #29.1) **add card reader and required hardware**

1 Single Door #150	new hdw	EXTERIOR from WAREHOUSE 150		LHR
1 Single Door #153C	new hdw	LOADING DOCK 153 from STAIRS 136		LHR
1 Single Door #271	new hdw	EXTERIOR from HALL 246		RHR
Opening Description: 3' 0" x 7' 0" x 1 3/4" x HMD Type ED-1-HM x HMF Type EF-1-HM (153C, 271) 3' 0" x 7' 0" x 1 3/4" x HMD Type ED-1-HM x HMF Type EF-1-HM x 60 MIN. (150)				
3 Reused(By Others)	EXISTING HARDWARE TO BE REUSED			MISC
3 Weatherstrip	2891 APK 1 x 36" 2 x 84"			PE

locktype?

Heading #30.0 (Set #30.0)

1 Pair Doors #100A		EXTERIOR from VEST 100		NH
1 Pair Doors #100B		VEST 100 from MAIN LOBBY 101		NH
Opening Description: 2 - 3' 10 1/4" x 7' 0" Type D-14-AL Type F-3-AL (100B) 2 - 3' 10 1/4" x 7' 0" Type D-3-AL Type F-3-AL (100A)				

Note: Balance of Hardware by Door Supplier.

Storefront supplier to confirm hardware compatible. Hardware is for a 1 3/4" wide stile door.

2 Reused(By Others)	EXISTING HARDWARE TO BE REUSED			MISC
---------------------	--------------------------------	--	--	------

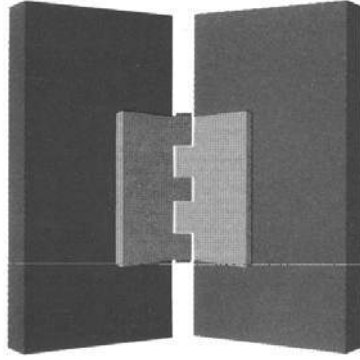

**HARDWARE
PRODUCT DATA & CLOSEOUT DOCUMENTS**

McKinney TA2714

Five Knuckle Standard Weight Hinge



SPECIFICATIONS:

MATERIAL:

Steel

DESCRIPTION:

Five Knuckle Standard
Weight Hinge

FASTENERS:

- (8) 1/2" x 12-24 Machine Screws
- (8) 1 1/4" x #12 Wood Screws

OPTIONS:

- NRP–Non-Removable Pin
- IB–Ball Bearing
- TCA–Concealed Bearing
- RC–Round Corner - 1/4" radius furnished unless specified
- HT–Hospital Tip
- BT–Ball Tip
- FT–Flat Decorative Tip
- GT–Grooved Tip
- LT–Lined Tip
- RT–Round Tip
- ST–Steeple Tip
- SSF–Safety Stud Feature
- CC–4, 8, or 12 wire available
- CC-18–2, 4, 6, 8, or 10 wire available (2-18AWG wires and the remainder 28AWG wires)
- QC–4, 8, or 12 wire available
- MM–Magnetic Monitoring

NOTES:

- When doors are beveled specify TA4714

SIZE:

4 1/2" x 4 1/2"

AVAILABLE FINISHES:

- P–Prime Coat
- US3/632
- US4/633
- US5/609
- US9/637
- US10/639
- US10A/641
- US10B/640
- US15/646
- US26/651
- US26D/652
- D3–Dark Bronze Powder Coat
- 10BE–Bronze Satin Powder Coat
- BSP–Black Suede Powder Coat
- WSP–White Suede Powder Coat

PACKAGED/WEIGHT:

- 3 ea Per Box
- 48 ea Per Case
- Case Weight–55 lbs

UL/ANSI:

NFPA 80 UL Openings
A8112 Grade 2

McKinney TA2714

Five Knuckle Standard Weight Hinge



SPECIFICATIONS:

MATERIAL:

Steel

DESCRIPTION:

Five Knuckle Standard
Weight Hinge

FASTENERS:

- (8) 1/2" x 12-24 Machine Screws
- (8) 1 1/4" x #12 Wood Screws

OPTIONS:

- NRP–Non-Removable Pin
- TB–Ball Bearing
- TCA–Concealed Bearing
- RC–Round Corner - 1/4" radius furnished unless specified
- HT–Hospital Tip
- BT–Ball Tip
- FT–Flat Decorative Tip
- GT–Grooved Tip
- LT–Lined Tip
- RT–Round Tip
- ST–Steeple Tip
- SSF–Safety Stud Feature
- CC–4, 8, or 12 wire available
- CC-18–2, 4, 6, 8, or 10 wire available (2-18AWG wires and the remainder 28AWG wires)
- QC–4, 8, or 12 wire available
- MM–Magnetic Monitoring

NOTES:

- When doors are beveled specify TA4714

SIZE:

5" x 4 1/2"

AVAILABLE FINISHES:

- P–Prime Coat
- US3/632
- US4/633
- US5/609
- US10/639
- US10A/641
- US10B/640
- US15/646
- US26/651
- US26D/652
- 10BE–Bronze Satin Powder Coat
- BSP–Black Suede Powder Coat
- WSP–White Suede Powder Coat

PACKAGED/WEIGHT:

- 3 ea Per Box
- 24 ea Per Case
- Case Weight–32 lbs

UL/ANSI:

NFPA 80 UL Openings
A8112 Grade 2

McKinney T4A3386

Five Knuckle Heavy Weight Hinge



SPECIFICATIONS:

MATERIAL:

Stainless

DESCRIPTION:

Five Knuckle Heavy
Weight Hinge

FASTENERS:

- (8) 1/2" x #12-24 Machine Screws
- (8) 1 1/4" x #12 Wood Screws

OPTIONS:

- NRP-Non-Removable Pin
- TB-Ball Bearing
- TCA-Concealed Bearing
- RC-Round Corner - 1/4" radius furnished unless specified otherwise
- HT-Hospital Tip
- BT-Ball Tip
- FT-Flat Tip
- ST-Steeple Tip
- SSF-Safety Stud Feature
- RB-Raised Barrel
- QC-4, 8, or 12 wire available
- CC-4, 8, or 12 wire available
- CC-18-2, 4, 6, 8, or 10 wire available (2-18AWG wires and the remainder 28AWG wires)
- MM-Magnetic Monitoring

SIZE:

4 1/2" x 4 1/2"

AVAILABLE FINISHES:

- P-Prime Coat
- US3/605
- US4/606
- US10/609
- US10A/614
- US10B/613
- US26/625
- US26D/626
- US32/629
- US32D/630
- US10BE(SS)-Dark Satin Bronze Powder Coat
- US10B(SS)/613
- BSP-Black Suede Powder Coat
- WSP-White Suede Powder Coat

PACKAGED/WEIGHT:

- 3 ea Per Box
- 24 ea Per Case
- Case Weight-37 lbs

UL/ANSI:

NFPA 80 UL Openings
SS A5111 Grade 1
BRS A2111

McKinney T4A3786

Five Knuckle Heavy Weight Hinge



SPECIFICATIONS:

MATERIAL:

Steel

DESCRIPTION:

Five Knuckle Heavy
Weight Hinge

FASTENERS:

- (8) 1/2" x #12-24 Machine Screws
- (8) 1 1/4" x #12 Wood Screws

OPTIONS:

- NRP-Non-Removable Pin
- TB-Ball Bearing
- TCA-Concealed Bearing
- RC-Round Corner - 1/4" radius furnished unless specified otherwise
- HT-Hospital Tip
- BT-Ball Tip
- FT-Flat Tip
- ST-Steeple Tip
- SSF-Safety Stud Feature
- RB-Raised Barrel
- QC-4, 8, or 12 wire available
- CC-4, 8, or 12 wire available
- CC-18-2, 4, 6, 8, or 10 wire available (2-18AWG wires and the remainder 28AWG wires)
- MM-Magnetic Monitoring

SIZE:

5" x 4 1/2"

AVAILABLE FINISHES:

- P-Prime Coat
- US3/632
- US4/633
- US10/639
- US10A/641
- US10B/640
- US15/642
- US26/651
- US26D/652
- BSP-Black Suede Powder Coat
- WSP-White Suede Powder Coat

PACKAGED/WEIGHT:

- 3 ea Per Box
- 24 ea Per Case
- Case Weight-41 lbs

UL/ANSI:

NFPA 80 UL Openings
A8111 Grade 1

MARKAR HG305 ADJUSTABLE HINGE GUARD

Standard Features

Barrel Type Hinge

.187" diameter Stainless Steel pin (rod)
Medical bearings
Stainless Steel end pins

Material

Heavy-duty 14 gauge Stainless Steel

Finishes

US32D Satin Stainless Steel (630)

Standards

ANSI/BHMA Standard A156.26 Grade 1

Mounting Hardware

Fasteners concealed when door is closed

Custom 12-24 x 1¹/₁₆" S.S Phillips Flat Head Undercut TEK Screws

Capacity

Supports weights up to 300 lbs.
4'0" maximum door width

Standard Sizes

6'8", 7'0", 7'2", 8'0", 10'0"

Hole Pattern

Symmetrically templated

Handing

Not required for standard 7'0", 8'0" or 10'0". Handing required for 6'8" and 7'2" and for most optional features listed

Fire Rating

3 hours- hollow metal doors
90 minutes- hollow metal and composite
20 minutes- wood doors



Classified in accordance with UL10C for positive pressure



Fire-rated label

Windstorm

Products is constructed in accordance with Guidelines FEMA 320 & FEMA 361.

Optional Features

Finish

US32 Bright Stainless Steel (629)
Scratch-Resistant Powder Coated Paint

Fasteners

Adjust-A-Screw™ for correcting frame fit problems up to 3³/₈"

Other Features

Custom lengths- specify in inches
Custom hole pattern
Dutch door hinges- suffix "DDP"
Hospital tips – suffix "HT"
Raised barrel – suffix "RB"
Welded end pins
Security studs

Electrical Modifications

Adjustable Monitoring Switch - suffix "AMS"
Current Transfer Prep - suffix "CTP"
Electrical Transfer Access Prep - suffix "ETAP"

ElectroLynx®

EL4 (4 wire), EL8 (8 wire), **EL12 (12 wire)**,
PoE (9 wire)

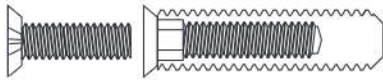

The integral hinge guard protects the door from dings and gouges from carts and gurneys while providing clean lines and aesthetic appearance. Our HG products also have fire ratings up to and including 3 hours. Not only that, but the wrap-around edge guard protects the door from unsightly dents and gouges and will deflect objects, preventing further damage.

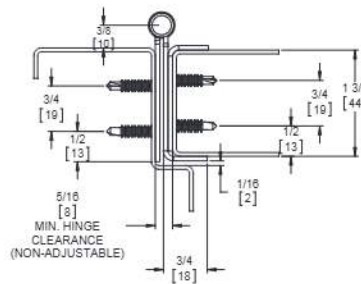

Door Closed

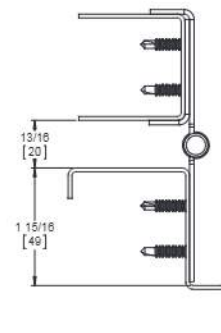

Door Open 180°



Experience a safer and more open world

800-824-3018 | www.pemko.com
Check the web site for the up-to-date catalog

Copyright © 2015-2025, ASSA ABLOY Accessories and Door Controls Group, Inc., an ASSA ABLOY Group company. All rights reserved. Reproduction in whole or in part without the express written permission of ASSA ABLOY Accessories and Door Controls Group, Inc. is prohibited.

MARKAR HG310 SWING CLEAR ADJUSTABLE HINGE GUARD

Standard Features

Barrel Type Hinge

.187" diameter Stainless Steel pin (rod)
 Medical bearings
 Stainless Steel end pins

Material

Heavy-duty 14 gauge Stainless Steel
 Finishes
 US32D Satin Stainless Steel (630)

Standards

ANSI/BHMA Standard A156.26 Grade 1

Mounting Hardware

Fasteners concealed when door is closed
 Custom 12-24 x 1¹/₁₆" S.S Phillips Flat Head Undercut TEK Screws

Capacity

Supports weights up to 300 lbs.
 4'0" maximum door width

Standard Sizes

6'8", 7'0", 7'2", 8'0", 10'0"

Hole Pattern

Symmetrically templated

Handing

Not required for standard 7'0", 8'0" or 10'0". Specify handing for 6'8" and 7'2" and for most optional features

Door Edge

Square hinge edge
 Recommend Adjust-A-Screw for beveled hinge edge

Fire Rating

3 hours- hollow metal doors
 90 minutes- hollow metal and composite core wood fire doors
 20 minutes- wood doors



Classified in accordance with UL10C for positive pressure
 Fire-rated label

Optional Features

Finishes

US32 Bright Stainless Steel (629)
 Scratch-Resistant Powder Coated Paint

Fasteners

Tamper-proof security screws
 Adjust-A-Screws™ for correcting frame fit problems up to 3/8"

Other Features

Custom lengths- specify in inches
 Custom hole pattern
 Dutch door hinges - suffix "DDP"
 Hospital tips - suffix "HT"
 Welded End Pins

Electrical Modifications

Current Transfer Prep (door leaf only) - suffix "CTP"
 (EL-EPT-SC Power Transfer Recommended)

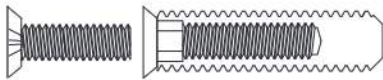

The ADA-compliant hinge is used on operating room doors to swing the door out of the opening when moving equipment in and out. The hinge guard also protects the door in the open position.

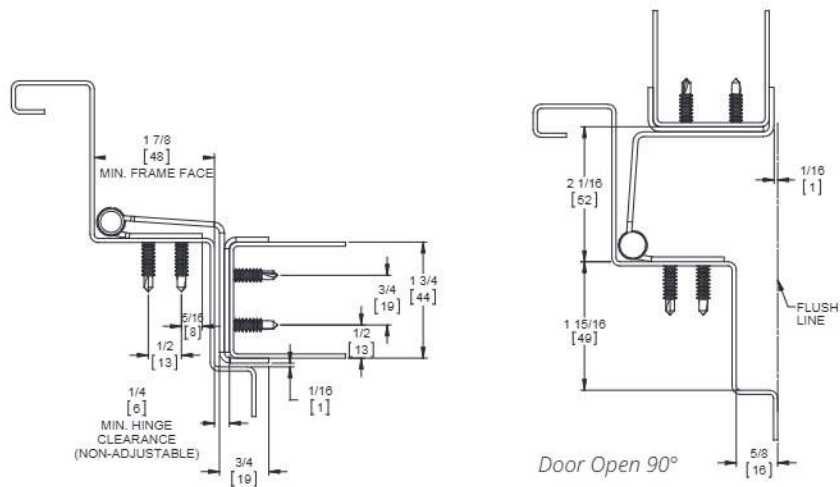

Door Closed

Door Open 90°



Experience a safer and more open world

800-824-3018 | www.pemko.com
 Check the web site for the up-to-date catalog

Copyright © 2015-2025, ASSA ABLOY Accessories and Door Controls Group, Inc., an ASSA ABLOY Group company. All rights reserved. Reproduction in whole or in part without the express written permission of ASSA ABLOY Accessories and Door Controls Group, Inc. is prohibited.

OFFSET HUNG

PIVOTS AND PIVOT SETS

MODEL 195

Description & Features

- Exterior or interior doors
- Weight to 450 lbs.*
- Door width up to 4'0" (1219mm)
- Handed
- 180 top pivot included
- 119 or M19 intermediate pivots are recommended (sold separately)
- 3/4" (19mm) offset (measured from centerline of pivot to face of door)
- Door edges must be beveled 1/8" in 2"
- Bottom pivot mortised into side jamb
- Pivot set can be vertically adjusted up to 3/16" (5mm) after installation without the use of shims
- Weight of door is borne by floor portion
- Doors will swing 180°, trim permitting
- Non-ferrous base material
- Doors 60" (1524mm) to 90" (2286mm) in height should use one intermediate pivot. Each additional 30" (762mm) of door height warrants another intermediate pivot
- Furnished with wood and machine screws
- Available in plated finishes

Optional Features

- Extended spindles available in 1/2" (13mm) increments up to 2" (51mm) longer than standard

Compliance

- Available for fire door assemblies up to three hours. Specify F195. Intermediate pivot required by UL. Specify FM19 (sold separately)
- ANSI/BHMA A156.4, Grade 2
- ANSI C07172

* Door size & weight guidelines are determined using the appropriate number of intermediate pivots

How to Order

Specify Model, Hand and Finish.



Technical Information

(Frame stop required)

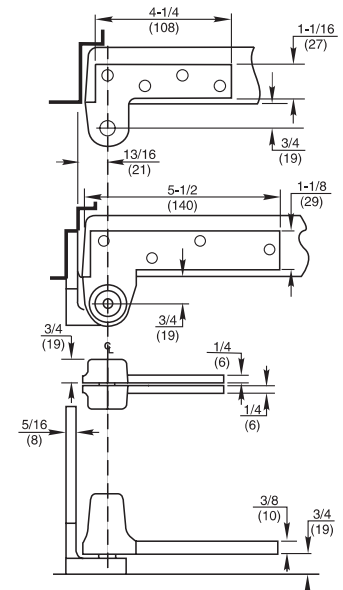

F195	If applicable, specify ext spdl x in. (lengths below)	LH	606						
↓	↓	↓	↓						
<table border="1"> <thead> <tr> <th>Model</th> <th>Description</th> </tr> </thead> <tbody> <tr> <td>195</td> <td>3/4" offset</td> </tr> <tr> <td>F195</td> <td>fire rated</td> </tr> </tbody> </table>	Model	Description	195	3/4" offset	F195	fire rated	EXTENDED SPINDLES 1/2" 1" 1-1/2" 2"	HAND LH - Left Hand RH - Right Hand	FINISH See page 69
Model	Description								
195	3/4" offset								
F195	fire rated								

INTERMEDIATE OR SIDE JAMB PIVOTS

PIVOTS AND PIVOT SETS

MODEL M19

Description & Features

- Full mortise
- Handed
- Not load-bearing
- Maintains door alignment
- Aids in installing floor closers and bottom pivots
- 3/4" (19mm) offset
- Door edges must be beveled in 1/8" in 2"
- Non-ferrous base metal
- Doors 60" (1524mm) to 90" (2286mm) in height should use one intermediate pivot. Each additional 30" (762mm) warrants another intermediate pivot
- Furnished with wood and machine screws
- Available finishes: plated (M19, M19-20); plated or sprayed finishes (FM19)

Optional Features

- Available for 1-1/2" (38mm) offset

Compliance

- Available for fire door assemblies (ferrous material) - specify FM19
- For 20-minute label suffix "-20" to the part number
- Cal Fire 3725-0047:0108 (-20 min)

How to Order

Specify Model, Hand, and Finish.

M19	
Model	Description
M19	3/4" offset (standard)
M19 x 1-1/2"	1-1/2" offset
M19-20	20 minute label, 3/4" offset
M19-20 x 1-1/2"	20 minute label, 1-1/2" offset
FM19	fire rated, 3/4" offset
FM19 x 1-1/2"	fire rated, 1-1/2" offset

RH

↓

HAND
LH - Left Hand
RH - Right Hand

626

↓

FINISH
See page 69



Technical Information

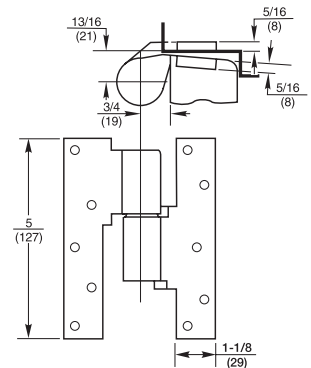

Mullions

ED2000 Series

CR900 Series Removable Mullions

The CR900 series mullions are used to install two ED2200 Rim Exit Devices in a double door opening. They may be quickly and easily removed, then reinstalled, when a full double door opening is temporarily required. The CR900 series mullions meet ANSI A156.3, Type 22.

Materials and Finish

Steel mullion with malleable iron top and bottom plates; furnished with zinc plated fasteners for metal frames and concrete floors. May be cut, drilled and tapped in the field for Rim Exit Devices. CR900 series mullions are primed grey for painting.

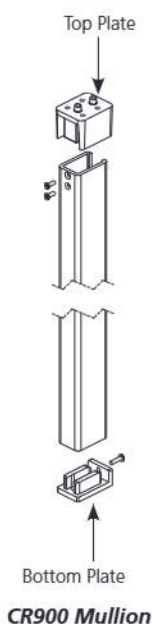

CR900 Series Mullions - Options

M95- Spacer Block

Recommended for double rabbeted frames where the stop face width is less than the mounting hole spacing and also for door frames 5-3/4" (176mm) or less. To order with a mullion, specify M95. To order separately, specify Part No. 683F29-8.

M96- Angle Bracket

Recommended for any header configuration with less than 3" (76mm) of mounting surface. To order with a mullion, specify M96. To order separately, specify Part No. 655F63-8.

M57- Mullion Stabilizer Kit

Controls the movement of the mullion. Recommended for opening over 7' high, or whenever door movement must be minimized. To order with mullion, specify M57. To order separately, specify Part No. 653F11-1 x 695 or 628.

CR900 Series Key Removable Mullion Cylinder Collar Packet

Mullion Series	Cylinder Length and Type			
	1-1/8"	1-1/4"	1-1/4" IC	1-1/2" IC
CR972BKM	610F01*	447F43*		609F37*
CR910BKM				
CR908KMSM				

Note: Cylinder collar packets contain a collar and spring washer.

*Specify finish when ordering packets.

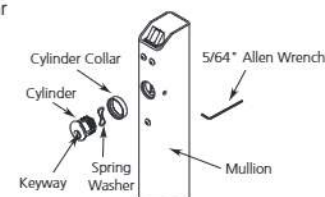

CR900 Series Mullions - How to Order

Removable Mullions

UL Fire Rating ¹	Mullion Opening Height ²	Catalog Number
Panic Only	Up to 7'2"	CR972
Panic Only	Up to 8'	CR908SM
3-Hour	Up to 7'2" (Only fire rated up to 8')	CR972A
3-Hour	Up to 10'0"	CR910A ⁴

Key Removable Mullions

UL Fire Rating ¹	Mullion Opening Height ²	Catalog Number
1-1/2 Hour	Up to 7'2"	CR972BKM ³
1-1/2 Hour	Up to 10'0" (Only fire rated up to 8')	CR910BKM ^{3,4}
Panic Only	Up to 8'	CR908KMSM

Notes:

- UL label on mullion indicates listing.
- May be field cut for doors.
- Cylinder and collars not included, specify separately. See Cylinders on page 12.
- For 8' length Mullion must be ordered as 10' length and cut in the field to 8' size

Cylinder Mullion Kit

Mullion Cylinder Kit #	Available with the Following Mullion Series:
CRMCK1	CR972KM
	CR972BKM
	CR910BKM
	CR908KMSM

Note: Mullion cylinder kit contains washer, collar and cylinder

*Specify finishes and cylinder code when ordering

**See page 15 for cylinder codes

Ex: CRMCK1 x Finish x Cylinder Code
(i.e. CRMCK1 x 630 x 6P)

Note: Cylinder Mullion Kit contains cylinder, collar and spring washer.

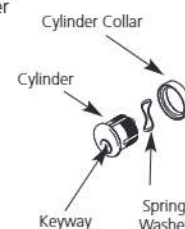



ML2000 Series

Mortise Locksets













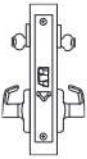



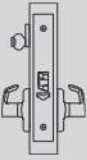



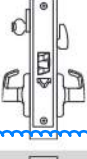

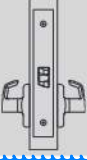
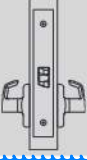









Product Catalog

Experience a safer
and more open world

Functions

ML2000 Series











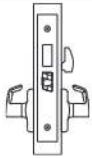

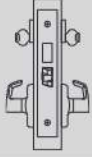

Outside	Inside	Function (ANSI No.)	Type	Function Description
 	 	ML2002	Classroom Intruder	<ul style="list-style-type: none"> Latchbolt by grip either side, unless outside grip is locked by key either side. Outside grip locked or unlocked by cylinder either side. Auxiliary latch deadlocks latchbolt. Inside grip always free.
 	 	ML2003	Classroom	<ul style="list-style-type: none"> Lock or unlock outside grip by key. Latchbolt by grip either side, unless outside grip is locked. Inside grip always free. Auxiliary latch deadlocks latchbolt.
 	 	ML2004	Classroom	<ul style="list-style-type: none"> Latchbolt by grip either side, unless outside grip is locked by key outside or thumbturn inside. Outside grip locked or unlocked by key or thumbturn. Inside grip always free. Auxiliary latch deadlocks latchbolt.
 		ML2010 (F01)	Passage or Closet	<ul style="list-style-type: none"> Latchbolt by grip either side. Both grips always free.
 	 	ML2011 (F18)	Deadlock	<ul style="list-style-type: none"> Deadbolt by key outside. No inside operation. <p>Note: Indicators available for sectional trim only.</p>
 	 	ML2012 (F16)	Deadlock	<ul style="list-style-type: none"> Deadbolt by key either side. <p>Note: Indicators available for sectional trim only.</p>
 	 	ML2013 (F17)	Deadlock	<ul style="list-style-type: none"> Deadbolt by key outside or by thumbturn grip inside. <p>Note: Indicators available for sectional trim only.</p>
 	 	ML2017 (F29)	Classroom Deadlock	<ul style="list-style-type: none"> Deadbolt by key outside. Thumbturn grip inside retracts deadbolt only; will not project deadbolt.

 Indicator options available for both sectional and VN escutcheon trim.

 Cylinder cam required.

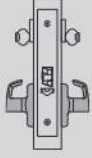
 Indicates rigid grip.

* When lever handles are furnished, both outside and inside are locked when deadbolt is projected.

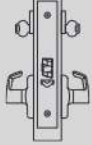
Outside	Inside	Function (ANSI No.)	Type	Function Description
		ML2020 (F02)	Privacy Bedroom or Bathroom	<ul style="list-style-type: none"> Latchbolt by grip* either side, when deadbolt is retracted. Deadbolt by thumbturn grip inside or by emergency release tool outside. No simultaneous deadbolt and latch retraction. Non-panic release. Not available with M19S or M19SN.
 A01		ML2022 (F14)	Store Door	<ul style="list-style-type: none"> Latchbolt by grip* either side when deadbolt is retracted. Deadbolt by key either side. Latchbolt retracted by key either side. Non-panic release. No simultaneous deadbolt and latch retraction.
 A01		ML2024 (F21)	Entrance or Storeroom	<ul style="list-style-type: none"> Latchbolt by grip* either side when deadbolt is retracted. Deadbolt by key outside or by thumbturn grip inside. Latchbolt retracted by key outside. Non-panic release. No simultaneous deadbolt and latch retraction.
 A01		ML2029 (F15)	Hotel or Motel	<ul style="list-style-type: none"> Latchbolt by grip inside and by guest key or master key outside. Outside grip always rigid. Deadbolt by thumbturn grip inside or by emergency key outside. Inside grip simultaneously retracts latchbolt and deadbolt. Emergency key shuts out all other keys. Auxiliary latch deadlocks latchbolt. <p>Note: Indicator shows deadbolt position only.</p>
		ML2030 (F19)	Privacy Bedroom or Bathroom	<ul style="list-style-type: none"> Latchbolt by grip either side unless outside grip locked by thumbturn. Deadbolt by thumbturn grip inside or by emergency release tool outside. Inside grip simultaneously retracts latchbolt and deadbolt and unlocks outside grip. Not available with M19S or M19SN.
 A01		ML2032 (F30)	Institution or Utility	<ul style="list-style-type: none"> Latchbolt by key either side. Both grips always rigid. Auxiliary latch deadlocks latchbolt. <p>Note: This function does not allow free egress and can pose a life safety hazard in event of an emergency. Installation should be in accordance with approved codes only.</p>
		ML2040	Passage with Indicator	<ul style="list-style-type: none"> For doors with indicator that do not require locking Latchbolt retracted by grip either side at all times Throwing thumbturn on inside changes state of status indicator Rotating either grip returns indicator to previous state <p>Note: Only available with "V" series indicators. Indicator option code must be specified with this function</p>
 A01		ML2042 (F09)	Entrance or Public Restroom	<ul style="list-style-type: none"> Latchbolt by grip either side, unless outside grip is locked by key from inside. Latchbolt by key outside when outside grip is locked. Auxiliary latch deadlocks latchbolt. Inside grip always free.

 Indicator options available for both sectional and VN escutcheon trim.











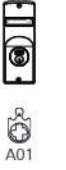
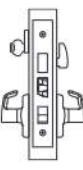

 Cylinder cam required.

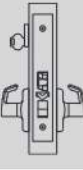
 Indicates rigid grip.

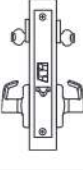
* When lever handles are furnished, both outside and inside are locked when deadbolt is projected.

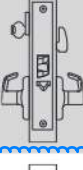
Functions

ML2000 Series











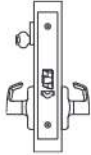
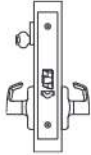

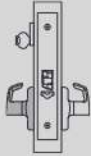
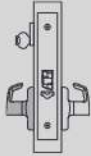

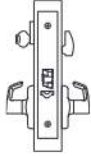
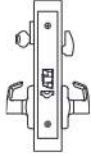

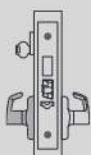
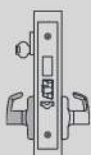
Outside	Inside	Function (ANSI No.)	Type	Function Description
		ML2048 (F08/F10)	Entrance or Apartment	<ul style="list-style-type: none"> Latchbolt* by key outside or by grip either side, unless outside grip is locked by toggle-action stop. Deadbolt by key outside or by thumbturn grip inside. Inside grip free when deadbolt is retracted. Non-panic release. No simultaneous deadbolt and latch retraction. Note: Indicator shows deadbolt position only.
		ML2049	Storeroom Deadbolt	<ul style="list-style-type: none"> Latchbolt and deadbolt by grip inside or by key outside. Inside grip simultaneously retracts deadbolt and latchbolt. Outside grip always rigid. Deadbolt thrown or retracted by key outside or thumbturn grip inside. Auxiliary latch deadlocks latchbolt. Inside grip always free. Note: Indicator shows deadbolt position only.
		ML2050	Half Dummy Trim	<ul style="list-style-type: none"> Grip acts as pull only; no operation.
		ML2051 (F04)	Entrance or Office	<ul style="list-style-type: none"> Latchbolt by key when outside grip locked by toggle action stop. Latchbolt by grip either side, unless outside grip is locked by toggle-action stop. Auxiliary latch deadlocks latchbolt. Inside grip always free.
		ML2052 (F32)	Classroom Intruder	<ul style="list-style-type: none"> Latchbolt by grip either side, unless outside grip is locked by key either side. Latchbolt by key when outside grip locked. Auxiliary latch deadlocks latchbolt. Inside grip always free. Outside grip remains locked unless unlocked by key either side. Note: Not available with indicator, specify ML2002.
		ML2053	Entrance or Office	<ul style="list-style-type: none"> Latchbolt by grip either side, unless outside grip is locked or unlocked by key or thumbturn. Outside grip locked or unlocked by key or thumbturn. Latchbolt by key when outside grip locked. Auxiliary latch deadlocks latchbolt. Inside grip always free.
		ML2054 (F04)	Entrance or Office	<ul style="list-style-type: none"> Latchbolt by grip either side, unless outside grip is locked. Outside grip locked or unlocked by thumbturn. Latchbolt by key when outside grip locked. Auxiliary latch deadlocks latchbolt. Inside grip always free. Multi-function capable, see page 10 for more info.
		ML2055 (F05)	Classroom	<ul style="list-style-type: none"> Latchbolt by grip either side, unless outside grip is locked by key outside. Latchbolt by key when outside grip locked. Auxiliary latch deadlocks latchbolt. Inside grip always free. Outside grip remains locked unless unlocked by key. Note: Not available with indicator, specify ML2003.

 Indicator options available for both sectional and VN escutcheon trim.

 Cylinder cam required.

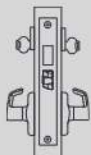
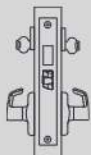
 Indicates rigid grip.

* When lever handles are furnished, both outside and inside are locked when deadbolt is projected.

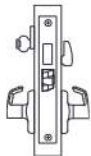
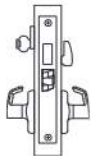
Outside	Inside	Function (ANSI No.)	Type	Function Description
 		ML2056 (F06)	Classroom Holdback	<ul style="list-style-type: none"> Latchbolt by grip either side, unless outside grip is locked or unlocked by key. Latchbolt by key outside when outside grip is locked. Latchbolt can be held in a retracted position by key, or released by key. Auxiliary latch deadlocks latchbolt. Inside grip always free. <p>Note: Not Listed for use in fire rated applications.</p>
 		ML2057 (F07)	Storeroom or Closet	<ul style="list-style-type: none"> Latchbolt by grip inside or by key outside. Outside grip always rigid. Auxiliary latch deadlocks latchbolt. Inside grip always free.
 		ML2058	Entrance or Office Holdback	<ul style="list-style-type: none"> Latchbolt by grip either side, unless outside grip is locked. Outside grip locked or unlocked by key or thumbturn. Latchbolt retracted by key outside when outside grip is locked. Latchbolt can be held in a retracted position by key or thumbturn, or released by key or thumbturn. Auxiliary latch deadlocks latchbolt. Inside grip always free. <p>Note: Not Listed for use in fire rated applications.</p>
  		ML2059	Security Storeroom or Closet	<ul style="list-style-type: none"> Latchbolt and deadbolt by grip inside or by key outside. Inside grip simultaneously retracts deadbolt & latchbolt. Outside grip always rigid. Auxiliary latch deadlocks latchbolt. Inside grip always free. <p>Note: Indicator shows deadbolt position only.</p>
 		ML2060 (F22)	Privacy	<ul style="list-style-type: none"> Latchbolt by grip either side, except when outside grip is locked by thumbturn inside. Operating inside grip, closing door or operating emergency key outside unlocks outside grip. Inside grip always free. Not available with M19S or M19SN.
  	 	ML2062 (F33)	Intruder Deadbolt	<ul style="list-style-type: none"> Latchbolt by grip either side, unless outside grip is locked by projection of deadbolt. Deadbolt thrown or retracted by key from either side. Inside grip simultaneously retracts latchbolt and deadbolt and unlocks outside grip. Inside grip always free.
  		ML2065 (F13)	Dormitory or Entrance	<ul style="list-style-type: none"> Latchbolt by grip either side unless outside grip locked by projection of deadbolt. Deadbolt thrown or retracted by key outside or by thumbturn grip inside. Inside grip simultaneously retracts latchbolt and deadbolt and unlocks outside grip. Inside grip always free.

 Indicator options available for both sectional and VN escutcheon trim.

 Cylinder cam required.

 Indicates rigid grip.

* When lever handles are furnished, both outside and inside are locked when deadbolt is projected.

Trim Designs

ML2000 Series

Lustra



Complies with codes requiring lever to return to within 1/2" (13mm) of door face.
Brass, bronze or stainless steel.

LWA

Lever: Wrought
Rose: Wrought



LWB

Lever: Wrought
Rose: Cast

LSA

Lever: Cast
Rose: Wrought

LSB

Lever: Cast
Rose: Cast

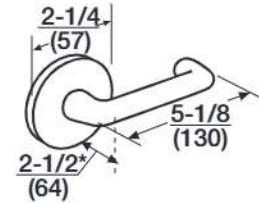

LWF

Lever: Wrought
Rose: Cast

LSF

Lever: Cast
Rose: Cast

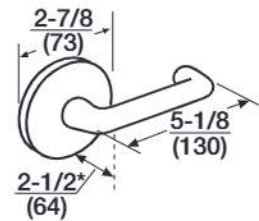

*Dimension from face of door, not surface of rose or escutcheon.

Dimensions:

inches
millimeters

Options and Accessories

ML2000 Series

Strikes

ANSI Straight Lip (standard)

Brass or stainless steel

Non-handed

4-7/8" (124mm) x 1-1/4" (32mm) x 1-1/8" (29mm) lip to center (standard)

Optional lip lengths: See chart on page 79



ANSI Curved Lip

Brass or stainless steel

Handed

4-7/8" (124mm) x 1-1/4" (32mm) x 1-1/4" (32mm) lip to center (standard)

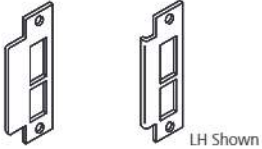
Optional lip lengths: See chart on page 79

	Part No.	Description
<p>Note: Only Available with ML2000</p>  <p>LH Shown</p> <p>All Functions</p>	236L72	Straight Lip
	340L60	Curved Lip for RHL/LHR
	340L61	Curved Lip for LH/RHR
 <p>Blank Filler Plate</p>	236L70	Straight Lip

To order strike with lockset, see How to Order, page 78.

To order strike separately, specify Part No. x Lip Length x Finish (e.g., 340L60 x 1-1/2" x 626).

ANSI Wrought Strike Box

To order with lockset, see

Quick Codes, page 81.

To order separately, specify 120F76.



Open Back

Size: 4-7/8" (124mm) x 1-1/4" (32mm)

Finish: Black Nylon.

Hand	Door Thickness	Part
RHR/LHR	1-3/4" (44mm)	653L163016
	2-1/4" (57mm)	653L163020

Available separately.

To order, specify Part Number.

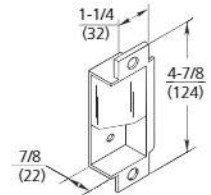

Rabbeted Front and Strike

Stainless Steel

For 1/2" (13mm) rabbet

No optional lip lengths

Non-handed

	Part No.
All Functions	318F66

To order with lockset, see

Quick Codes, page 81. To

order separately, specify

Part No. x Finish

(e.g., 318F66 x 626).

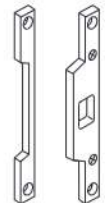

How to Order the Muséo® Piet Levers

ML2000 Series



Grooved Insert
21G



Leather Insert
21L



Polished with
Satin Insert
21M



Santoprene™
Insert
21S



With Raised Band
23M



Plain
25M



Plain with Two
Grooves
27M

Piet Finish Codes

ANSI/BHMA & Corbin Russwin Finish Code	Piet Code*	Description
630	30	Satin Stainless Steel
629	29	Bright Stainless Steel
N/A	BK	Black (Santoprene™ or leather insert)
N/A	BN	Brown (leather insert)
N/A	00	No Insert
613E	3E	Dark Satin Bronze Equivalent
BSP	BS	Black Suede
WSP	WS	White Suede

*Code used to specify Piet Collection finishes only. Use available finishes list to specify desired finish when ordering.

Piet Lever Descriptions & Available Finishes

Lever Designation	Lever Description	Available Finishes (as ordered)
21G	Grooved Insert	303030, 292929, 293029, 302930, 3E003E, BS00BS, WS00WS
21L	Leather Insert	30BK30, 30BN30, 29BK29, 29BN29, 3EBK3E, BSBKBS, WSBKWS, 3EBN3E, BSNBNS, WSNBNS
21M	Metallic Insert	293029**
21S	Santoprene Insert	30BK30, 29BK29, 3E003E, BS00BS, WS00WS
23M	Raised Band	290030**, 290029, 300030, 300029***, 3E003E, BS00BS, WS00WS
25M	Plain	290029, 300030, 3E003E, BS00BS, WS00WS
27M	Two Grooves	290029, 300030, 3E003E, BS00BS, WS00WS

**Two-tone finish - grip of lever is 630, balance of lever is 629. Rose/escutcheon and lock finish will be 629.

***Two-tone finish - grip of lever is 629, balance of lever is 630. Rose/escutcheon and lock finish will be 630.

Ordering Examples

Rose Options: E2, E3, E4, T, U, V, W, X, Y

Escutcheon Options: L, R

Quantity	Series/Function	Trim	Lever Finish	Lock Finish	Hand	Thumbturn Options
2	ML2054	21LU	29BK29	629	RH	MT3
1	ML2054	23ML	290030	629	RH	MT3

Quick Codes

ML2000 Series

Cylinder and Keying

Description	Specify
Conventional 6-pin	(standard)
Conventional 7-pin	7P
Less Cylinder(s)	LC
LFIC	
LFIC 6-pin	C6
LFIC 6-pin Less Core	CL6
LFIC 6-Pin Disposable Core	CT6D
LFIC 6-pin with Temporary Construction Core (Red)	CT6R
LFIC 6-pin with Temporary Construction Core (Blue)	CT6B
LFIC 6-pin with Temporary Construction Core (Green)	CT6G
LFIC 7-pin	C7
LFIC 7-pin Less Core	CL7
LFIC 7-Pin Disposable Core	CT7D
LFIC 7-pin with Temporary Construction Core (Red)	CT7R
LFIC 7-pin with Temporary Construction Core (Blue)	CT7B
LFIC 7-pin with Temporary Construction Core (Green)	CT7G
SFIC	
SFIC 6-pin	C6S
SFIC 6-pin Less Core ¹	CLS6
SFIC 6-Pin Disposable Core ¹	CT6SD
SFIC 6-pin with Temporary Construction Core (Blue)	CT6SB
SFIC 7-pin	C7S
SFIC 7-pin Less Core ¹	CLS7
SFIC 7-Pin Disposable Core ¹	CT7SD
SFIC 7-pin with Temporary Construction Core (Blue)	CT7SB
Security	
Security	HS
Security LFIC	CHS
Access 3®	
Access 3® Patented Fixed Core	AP
Access 3® Security Fixed Core	AS
Access 3® High Security Fixed Core	AHS
Access 3® Patented LFIC	ACP
Access 3® Security LFIC	ACS
Access 3® High Security LFIC	ACHS
Pyramid	
Pyramid Security Fixed Core	PS
Pyramid High Security Fixed Core	PHS
Pyramid Security LFIC	PCS
Pyramid High Security LFIC	PCHS
Pyramid LFIC Less Core	CLP
Pyramid with Temporary Construction Core	CTP
Pyramid Disposable Core	CTPD
UL Housing	
LFIC 6-pin Less Core ³	CL6AH
LFIC 6-Pin Disposable Core ³	CTAHD
LFIC 6-pin with Temporary Construction Core (Red/Blue/Green) ³	CT6AH (R/B/G)

Cylinder and Keying (cont.)

Description	Specify
Other	
Master Ring ^{2,4}	MR
Flex Head Cylinder, 6-pin (sectional trim) ³	FX6
Flex Head Cylinder, 7-pin (sectional trim) ³	FX7
Flex Head Cylinder, Master Ring (sectional trim) ^{2,3}	FXM
Plug Only to Show, Less Cylinder	PO-LC
Plug Only to Show, 6-pin (concealed shell; M and R escutcheons only, single cylinder only) ³	PO6
Plug Only to Show, 7-pin (concealed shell; M and R escutcheons only, single cylinder only) ³	PO7
Keying and Keys	
0-bitted with 2 blank keys	0Bit (standard)
Keyed Random	KR
Construction Master Keyed (not available for Pyramid)	CMK
Uncombined	UC
2 keys per lock	(standard)
More than 2 keys	KY# (e.g., KY6)
Visual key control (VKC)	
No biting or keyset stamping on keys or cylinder	VKC0
Keys only	VKC1
Cylinders and keys (not for AS, AHS, ACS, ACHS, HS, CHS, PHS or PCHS)	VKC2
Cylinders only (not for AS, AHS, HS, ACS, ACHS, CHS, PHS or PCHS)	VKC3
Concealed key control (CKC)	
CKC cylinders with VKC keys	CKC2
CKC cylinders only (not for AS, AHS, HS, ACS, ACHS, CHS, PHS or PCHS)	CKC3

1. Not available with ML2029.
2. Not available for ML2017, ML2029, ML2032, ML2068, ML2000VR, ML20600 x NAC, ML20900, or MELR option.
3. Not available with ML2000VR
4. Not available UC (uncombined)

Finishes

ANSI/BHMA 605 (US3)	Bright Brass
ANSI/BHMA 606 (US4)	Satin Brass
ANSI/BHMA 611 (US9)	Bright Bronze
ANSI/BHMA 612 (US10)	Satin Bronze
ANSI/BHMA 613 (US10B)	Oxidized Bronze, oil rubbed
613E (US10BE)	Dark Oxidized Satin Bronze - Equivalent
613L	Dark Oxidized Satin Bronze, Clear Coated
ANSI/BHMA 618 (US14)	Bright Nickel Plated
ANSI/BHMA 619 (US15)	Satin Nickel Plated
ANSI/BHMA 625 (US26)	Bright Chromium Plated
ANSI/BHMA 626 (US26D)	Satin Chromium Plated
626C	Satin Chromium Plated with MicroShield®
ANSI/BHMA 629 (US32)	Bright Stainless Steel
ANSI/BHMA 630 (US32D)	Satin Stainless Steel ®
630C	Satin Stainless Steel with MicroShield®
722	Black Oxidized Bronze, oil rubbed
BSP	Black Suede Powder Coat
WSP	White Suede Powder Coat



MP9800 Series

Product Catalog

Experience a safer
and more open world

Features

Handing

Field Reversible.

Doors*

Metal doors, 1-3/4" (44mm) door thickness standard, 4-1/2" minimum stile, 2-1/4" backset standard.

Aluminum doors (Quick Code-MPAD), 1-3/4" (44mm) door thickness (STD), 1-7/8" minimum stile, 7/8" backset (STD) for double doors, 1-1/8" backset for single doors.

Wood doors (Quick Code-MPWD), 1-3/4" (44mm) door thickness standard, 4-1/2" minimum stile, 2-1/4" backset standard.

Mounting

Supplied fasteners are for all doors with through-bolts for trim.

Rods

Steel. Top and bottom bolt travels 7/16" (11mm) Projection adjustable up to 3/4" (19mm).

Latching

Top and Bottom or Top only (M55).

Trim

Features EcoFlex®. Available with all lever designs. Auxiliary Control offers cylinder override for 01, 40, 50, 903 & 905 functions.

Top and Bottom Bolts

Stainless steel top and bottom bolt travels 7/16" (11mm). Projection adjustable up to 1" (25mm).

Strikes

See page 13.

Cylinder

See cylinders page 12.

Applications

Pairs of doors that do not require panic devices

When flush bolts are not permitted in:

- Assembly
- Education
- Healthcare
- Hazard Occupancy

Single doors that do not require a panic device with power operators

***NOTE:** Must specify MPAD or MPWD when ordering

Thermal Pins

MP9800A x M55: supplied with ONE thermal pin per fire-rated lock, for installation on pairs of fire-rated doors.

Warranty

5 year.

Certification/Compliance

ANSI

Meets A117.1 Accessibility Code.

UL /cUL

Three-hour fire-rated locks listed as fire hardware for A label and lesser class 8' x 8' double doors; UL symbol on cover indicates listing. Any retrofit or other field modification to a fire-rated opening can potentially impact the fire rating of the opening, and Corbin Russwin, Inc. makes no representations or warranties concerning what such impact may be in any specific situation. When retrofitting any portion of an existing fire-rated opening, or specifying and installing a new fire-rated opening, please consult with a code specialist or local code official (Authority Having Jurisdiction) to ensure compliance with all applicable codes and ratings.

California State Reference Code

This product has been approved by the California State Fire Marshal pursuant to section 13144.1 of the California Health and Safety Code.

NFPA

All fire-rated locks comply with NFPA 80 Fire Doors and Windows.

ADA

Lever trims comply with Americans with Disabilities Act.

Featuring EcoFlex®*



- Reduces energy consumption up to 95%, as certified by GreenCircle
 - Lower operating costs
 - Assists with load reduction in optimizing energy performance credit in LEED
 - Reduces number of power supplies required
- Field configurable to fail-safe or fail-secure
- Lock operates from 12-24VDC, offering greater flexibility in system design
- Innovative actuator design provides superior reliability
 - Higher performance and reduced maintenance
 - Ability to have longer cable runs without negatively impacting lock function
 - Reduces risk of voltage drops and eliminates inductive kickback
 - Lower total cost of ownership

*Patent pending



Function Combinations

MP9800 Series

Available Function Combinations:		Inside Function (N)									
		10	45 ¹	49 ¹	50	52	55 ¹	59 ¹	903 ¹	905 ¹	
Blank Escutcheon Plate	Exterior Function (E)	01	X	X	X			X	X	X	X
Passage only (No cylinder)		10	X	X	X			X	X		
No outside Operation (No Cylinder); Pull Only		40 ²	X	X	X					X	X
Class Room Key Outside Unlocks/locks Trim		45	X	X	X						
Key unlocks Trim; Trim retracts latch; Trim relocks when key is removed		49	X	X	X					X	X
Freewheeling Trim; No Outside Operation		50						X	X		
Key outside unlocks/locks O/S trim; Key inside unlocks/locks O/S trim		52					X				
Freewheeling Trim; Key Outside Unlocks/locks Trim		55	X			X		X	X		
Freewheeling Trim; Key unlocks Trim; Trim retracts latch/Trim relocks when key is removed		59	X			X		X	X		
Electrified Trim - Fail Safe (No Cylinder)		903 ³	X	X	X					X	X
Electrified Trim - Fail Secure (No Cylinder)		905 ³	X	X	X					X	X

1. **Not recommended for use on any door used for Life Safety egress**
2. **Rigid lever**
3. **903 and 905 functions require the voltage to be specified, 12V or 24V.**

UL Ratings

Device	Maximum Door Opening	UL Fire Door Hardware Rating				Pair of Doors, Swinging in Same Direction. Notes:	Pair of Doors Swinging in Opposite Directions. Notes:
		3 Hours (A)	1-1/2 Hour (B)	3/4 Hour (B)	20 min. (B)		
MP9800(A/B) x MP9800(A/B)	8' x 10' Hollow Metal	X	X	X	X	2A, 2B	2B
MP9800(A/B) M55 x MP9800(A/B) M55	8' x 10' Hollow Metal	X	X	X	X	2A, 2B, 3A	2B, 3A
MP9800(B) MPWD x MP9800(B) MPWD	8' x 8' Wood		X	X	X	2A, 2B	2B
MP9800(B) M55 MPWD x MP9800(B) M55 MPWD	8' x 8' Wood		X	X	X	2A, 2B	2B

Any retrofit or other field modification to a fire rated opening can potentially impact the fire rating of the opening, and Corbin Russwin makes no representations or warranties concerning what such impact may be in any specific situation. When retrofitting any portion of an existing fire rated opening, or specifying and installing a new fire-rated opening, please consult with a code specialist or local code official (Authority Having Jurisdiction) to ensure compliance with all applicable codes and ratings.

Note 2A: An astragal cannot be used when both doors are active, unless a coordinator is also used.











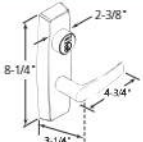
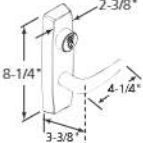

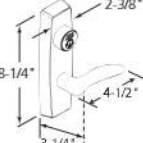
Note 2B: Door construction limitations or building code may require the use of an astragal to match the maximum hardware listing.

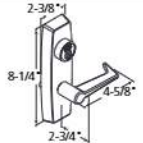
Note 3A: Hardware listing requires 2 thermal pins, door-to-door orientation.

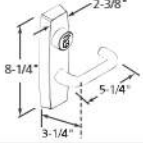
Features:

- Beveled edges
- 5-year limited warranty

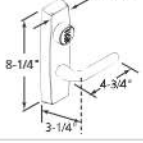
Note: Must designate E for exterior function or N for interior function when specifying order.

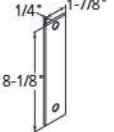
Pull Trim Design			Trim Designation	
	Armstrong Lever: Cast Escutcheon: Forged			A
	Citation Lever: Cast Escutcheon: Forged			C
	Dirke Lever: Cast Escutcheon: Forged Handed: Specify RHR or LHR			D
	Essex Lever: Cast Escutcheon: Forged			E
	Lustra Lever: Cast Escutcheon: Forged			L
	Newport Lever: Cast Escutcheon: Forged			N
	Regis Lever: Cast Escutcheon: Forged			R
	Princeton Lever: Cast Escutcheon: Forged			PR
	Blank Escutcheon Plate 01			01

Finishes

MP9800 Series

Finishes

Standard Levers Finish	Description	Standard Levers Finish	Description
605	Bright brass, clear coated	625	Bright chrome
606	Satin brass, clear coated	626	Satin chrome
611	Bright bronze, clear coated	626C	Satin chrome with Microshield
612	Satin bronze, clear coated	629	Bright stainless steel
613	Oxidized bronze, oil rubbed	630	Satin stainless steel
613E	Dark oxidized satin bronze, equivalent	630C	Satin stainless steel with Microshield
618	Bright nickel plated	722	Black oxidized bronze, oil-rubbed
619	Satin nickel, clear coated	BSP	Black Suede Powder Coat

Note: Split Finishes — specify outside finish first, then inside finish example: 626 (outside) / 606 (inside)

Piet Finish Codes

BHMA/ASSA ABLOY Finish	Piet Code*	Description
630	30	Satin Stainless Steel
629	29	Bright Stainless Steel
613E	3E	Dark Oxidized Satin Bronze, Equivalent
BSP	BS	Black Suede Powder Coat
WSP	WS	White Suede Powder Coat
N/A	BK	Black (Santoprene™ or leather insert)
N/A	BN	Brown (leather insert)
N/A	00	No Insert

*Code used to specify Piet Collection finishes only. Use available finishes list to specify desired finish when ordering.

Piet Lever Descriptions & Available Finishes

Lever Designation	Lever Description	Available Finishes (as ordered)
21G	Grooved Insert	292929, 303030, 3E003E, BS00BS, WS00WS
21L	Leather Insert	29BK29, 29BN29, 30BK30, 30BN30, 3EBK3E, 3EBN3E, BSBKBS, BSNBBS, WSBKWS, WSNBWS
21M	Metallic Insert	293029** only
21S	Santoprene Insert	29BK29, 30BK30, 3E003E, BS00BS, WS00WS
23M	Raised Band	290029, 300030, 290030**, 3E003E, BS00BS, WS00WS
25M	Plain	290029, 300030, 3E003E, BS00BS, WS00WS
27M	Two Grooves	290029, 300030, 3E003E, BS00BS, WS00WS

**Two-tone finish - grip of lever is 630, balance of lever is 629. Escutcheon finish will be 618.

Ordering Examples

Quantity	Series	Trim/Exterior Function	Trim/Interior Function	Finish	Lock Finish	Hand	Door Height	Cylinder Option	Misc. Options
4	MP9800A	25ME10	25MN10	300030	630	RHR	H0702	CL6	M55

Cylinders

MP9800 Series

Mortise



Rim

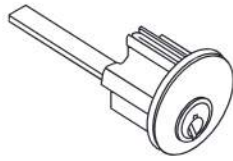

(Used for N52 function only)

Description	Cylinder Type	Collar Pack	Trim Functions							
			*45	*49	*E52 (Outside)	*N52 (Inside)	*55	*59	AUX155	AUX159
6 Pin	CR1000-118-A07	447F43	X	X	X		X	X	X	X
	CR3000-200	654F08				X				
7 Pin	CR1000-114-A07-7	723F94	X	X	X		X	X	X	X
	CR3000-200-7	654F08				X				
Access 3 Patented	CR1500-114-A07	723F94	X	X	X		X	X	X	X
	CR3500-200	654F08					X			
Access 3 Security	CR1600-114-A07	723F94	X	X	X		X	X	X	X
	CR3600-200	654F08				X				
Access 3 High Security	CR1700-114-A07	723F94	X	X	X		X	X	X	X
	CR3700-200	654F08				X				
Access3 IC Patented	CR1580-114-A07	723F94	X	X	X		X	X	X	X
	CR3580-178	654F08				X				
Access 3 IC Security	CR1680-114-A07	723F94	X	X	X		X	X	X	X
	CR3680-178	654F08				X				
Access 3 IC High Security	CR1788-114-A07	723F94	X	X	X		X	X	X	X
	CR3788-178	654F08				X				
Pyramid Security	CR1027-114-A07	723F94	X	X	X		X	X	X	X
	CR3027-200	654F08				X				
Pyramid Security IC	CR1037-114-A07	723F94	X	X	X		X	X	X	X
	CR3037-178	654F08				X				
Pyramid High Security	CR1020-114-A07	723F94	X	X	X		X	X	X	X
	CR3020-200	654F08				X				
Pyramid High Security IC	CR1030-114-A07	723F94	X	X	X		X	X	X	X
	CR3030-178	654F08				X				
Pyramid IC	CR1080-114-A07	723F94	X	X	X		X	X	X	X
LFC 6 Pin										
LFC 6 Pin - Red										
LFC 6 Pin - Blue							X			
LFC 6 Pin - Green										
Pyramid LFC (Disposable)	CR1070-114-A07	723F94	X	X	X		X	X	X	X
Pyramid LFC Less Core										
LFC 6 Pin Less Core										
LFC 6 Pin (Disposable)	CR3070-178	654F08				X				
SFIC 6 Pin										
SFIC 6-Pin - Blue	CR1050-114-A07	723F94	X	X	X		X	X	X	X
SFIC 6 Pin Less Core										
SFIC 6 Pin (Disposable)	CR1040-114-A07	723F94	X	X	X		X	X	X	X
SFIC 6 Pin										
SFIC 6-Pin - Blue	CR3050-178	654F08				X				
SFIC 6 Pin Less Core										
SFIC 6 Pin (Disposable)	CR3040-178	654F08				X				
Security	CR1010-114-A07	723F94	X	X	X		X	X	X	X
	CR3010-200	654F08				X				
Security LFC	CR1090-114-A07	723F94	X	X	X		X	X	X	X
	CR3090-178	654F08				X				
LFC 7 Pin	CR1080-134-A07-7	609F37	X	X	X		X	X	X	X
LFC 7 Pin - Red										
LFC 7 Pin - Blue							X			
LFC 7 Pin - Green										
SFIC 7 Pin	CR1050-134-A07	609F37	X	X	X		X	X	X	X
SFIC 7 Pin - Blue										
SFIC 7 Pin Less Core										
SFIC 7 Pin (Disposable)	CR1040-134-A07	609F37	X	X	X		X	X	X	X
SFIC 7 Pin										
SFIC 7 Pin - Blue	CR3050-178-7	654F08				X				
SFIC 7 Pin Less Core										
SFIC 7 Pin (Disposable)	CR3040-178-7	654F08				X				

Strikes & Back Plates

MP9800 Series

Top Strike (Metal and Wood Doors)

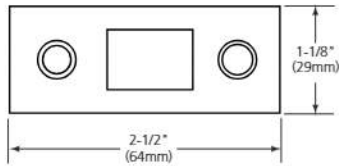

- For MP9800, MP9800A, MP9800 x M55, MP9800A x M55
- Stainless steel
- Part # 764F577

Strike Kits (Aluminum Doors)

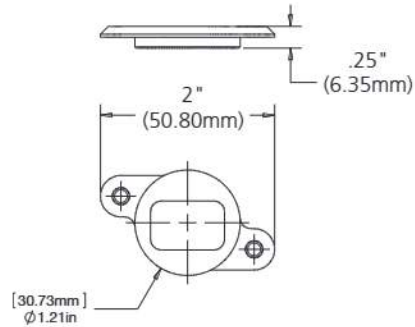

- For MP9800 x MPAD
- Steel with Black Nylon Coating
- Machine Screws Supplied
- 764F597 Kit contains 2 strikes (Top & Bottom)
- 764F607 Kit contains 1 strike (Top Only)

Bottom Strike (Metal and Wood Doors)

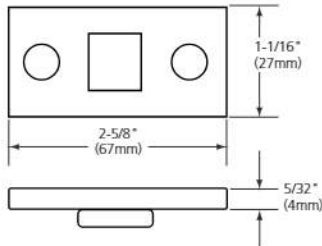

- For MP9800, MP9800A
- Mortised into floor
- Stainless steel
- Part # 764F587

MPER & MPES Trim Back Plates

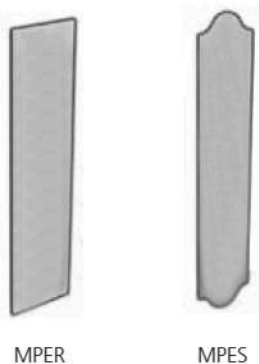

The back plates are:

- Mounted between the trim and the door
- Required for wood doors (MPWD)
- Optional on metal doors

Note: May be used to cover existing door preps

How to Order

MP9800 Series

Ordering Examples

Metal Door

Quantity	Series	Trim/Exterior Function	Trim/Interior Function	Finish	Hand	Door Thickness	Door Height	Misc. Options	Voltage for Electrified Trim*
65	MP9800	DE49	DN10	605	LHR	D214	H0800	M55	12VDC

Wood Door

Quantity	Series	Trim/Exterior Function	Trim/Interior Function	Finish	Hand	Door Thickness	Door Height	Misc. Options	Voltage for Electrified Trim*
11	MP9800	NE55	NN50	626	RHR	D214	H0706	MPWD, MPER	12VDC

*Specify voltage desired for 903 and 905 function (12VDC/24VDC)

Trim Designation Description

DE49

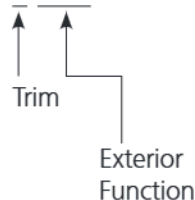

25MN10

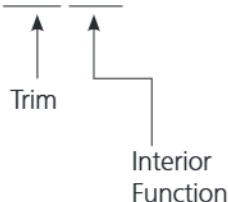

Where to find ordering information and Quick Codes

Functions	Pg 4 & 10
Trims.....	Pg 6
Cylinders and Keying.....	Pg 14
Door Height	Pg 14
Strike	Pg 13
Finish	Pg 15
Door Thickness.....	Pg 14
Handing.....	Pg 15
Miscellaneous Options	Pg 15

Quick Codes

MP9800 Series

Cylinder and Keying

Description	Specify
Conventional 6-pin	(standard) 6P
Conventional 7-pin	7P
Less Cylinder(s)	LC*
LFIC	
LFIC 6-pin	C6
LFIC 6-pin Less Core [®]	CL6
LFIC 6-pin Disposable Core [®]	CT6D
LFIC 6-pin with Temporary Construction Core (Red)	CT6R
LFIC 6-pin with Temporary Construction Core (Blue)	CT6B
LFIC 6-pin with Temporary Construction Core (Green)	CT6G
LFIC 7-pin [®]	C7
LFIC 7-pin Less Core [®]	CL7
LFIC 7-pin Disposable Core [®]	CT7D
LFIC 7-pin with Temporary Construction Core (Red)	CT7R
LFIC 7-pin with Temporary Construction Core (Blue)	CT7B
LFIC 7-pin with Temporary Construction Core (Green)	CT7G
SFIC	
SFIC 6-pin [®]	C6S
SFIC 6-pin with Temporary Construction Core (Blue) [®]	CT6SB
SFIC 6-pin with disposable temporary core [®]	CT6SD
SFIC 6-pin less core [®]	CLS6
SFIC 7-pin [®]	C7S
SFIC 7-pin with Temporary Construction Core (Blue)	CT7SB
SFIC 7-pin with disposable temporary core [®]	CT7SD
SFIC 7-pin less core [®]	CLS7
Security	
Security [®]	HS
Security LFIC [®]	CHS
Access 3[®]	
Access 3 [®] Patented Fixed Core [®]	AP
Access 3 [®] Security Fixed Core [®]	AS
Access 3 [®] High Security Fixed Core [®]	AHS
Access 3 [®] Patented LFIC [®]	ACP
Access 3 [®] Security LFIC [®]	ACS
Access 3 [®] High Security LFIC [®]	ACHS
Pyramid	
Pyramid Security Fixed Core [®]	PS
Pyramid High Security Fixed Core [®]	PHS
Pyramid Security LFIC [®]	PCS
Pyramid High Security LFIC [®]	PCHS
Pyramid LFIC Less Core [®]	CLP
Pyramid with Temporary Construction Core [®]	CTP
Pyramid Disposable Core [®]	CTPD

[®] Indicates availability with ML200VR lockset

*Not available with 52 function

Cylinder and Keying (cont)

Description	Specify
Keying and Keys	
Keyed Random [®]	KR
Construction Master Keyed (not available for Pyramid) [®]	CMK
2 keys per lock	(standard)
More than 2 keys	KY# (e.g., KY6)
Visual key control (VKC)[®]	
No bitting or keyset stamping on keys	VKC0
Keys only	VKC1
Cylinders and keys (not for AS, AHS, ACS, ACHS, HS, CHS, PHS or PCHS)	VKC2
Cylinders only (not for AS, AHS, ACS, ACHS, HS, CHS, PHS or PCHS)	VKC3
Concealed key control (CKC)[®]	
CKC cylinders with VKC keys	CKC2
CKC cylinders only (not for AS, AHS, ACS, ACHS, PHS, PCHS)	CKC3

1. Not available with ML2029.

2. Not available for ML2017, ML2029 or ML2032 x MR, ML2000HS or ML2000VR.

Door Height

Door Height	Specify
7'0"	(standard)
7'2"	H0702
7'6"	H0706
8'0"	H0800
9'0"	H0900
10'0"	H1000

Note: Maximum adjustment of rod length is 3/4"

Door Thickness

Door	Specify
1-3/4" (44mm)	(standard)
2" (51mm)	D200
2-1/4" (57mm)	D214

Quick Codes

MP9800 Series

Finish

Description	Specify
Bright Brass	605
Satin Brass	606
Bright Bronze	611
Satin Bronze	612
Dark Oxidized Satin Bronze, oil rubbed	613
Dark Oxidized Satin Bronze Equivalent	613E
Bright Nickel Plated	618
Satin Nickel Plated	619
Bright Chromium Plated	625
Satin Chromium Plated	626
Satin Chromium Plated with MicroShield®	626C
Bright Stainless Steel	629*
Stain Stainless Steel	630*
Black Suede Powder Coat	BSP

*Only available with Piet Collection

Lock/Cylinder Finish

Lock	Cylinder/Core*
605,606,611,612,613,613E,722	606
618,619,625,626,626C,629,630,630C	626
BSP	BSP

*Finish when cylinder provided with lock

Handing

Hand	Specify
Right Hand	RH
Right Hand Reverse	RHR
Left Hand	LH
Left Hand Reverse	LHR

Architectural Specifications

- Multi-Point Locking Solutions shall be MP9800 Series as manufactured by Corbin Russwin, Berlin, CT.
- Multi-Point Locking Solutions shall be listed by Underwriters Laboratories and bear the UL label in full compliance with NFPA 80. Multi-Point Locking Solutions for fire labeled doors shall be UL listed as "Fire Hardware".
- Rods shall be retracted in one operation by dual mounted lever controls with a complete range of functions, including electro-mechanical, on the secure side of the door.
- The lock shall also be available as a single latching lock with top latching only, eliminating the bottom strike.
- Lever trim shall be available in finishes and designs to match that of the specified locksets.
- Sargent 7000 Multi Point is the only approved substitute.
- Multi-point locks shall have a five year limited warranty.

Miscellaneous Options

Description	Specify
Torx® head screws	M04
Knurling outside and inside	M20 ²
Knurling outside only	M21 ²
Knurling inside only	M22 ²
Abrasive coat outside and inside	M23
Abrasive coat inside only	M24
Abrasive coat outside only	M25
Less bottom vertical rod	M55
Windstorm	M107
Aluminum Door	MPAD ¹
Rectangular Back Plate (Required for Wood Door - MPWD)	MPER
Back Plate (Required for Wood Door - MPWD)	MPES
Lever Hold Back	MPHB
Wood Door	MPWD ¹
Aux Control (Classroom)	AUX155
Aux Control (Storeroom)	AUX159

- 1 Must specify Quick Code when ordering for aluminum or wood doors
- 2 All levers provided in a powder coat finish will be supplied with an abrasive coating

Electrified Options

Description	Specify
Latchbolt Monitoring	M91
O/S Lever Monitoring	M93
I/S Lever Monitoring	M92
Electric Latch Retraction	MELR

Quick Codes

MP9800 Series

Cylinder and Keying

Description	Specify
Conventional 6-pin	(standard) 6P
Conventional 7-pin	7P
Less Cylinder(s)	LC*
LFIC	
LFIC 6-pin	C6
LFIC 6-pin Less Core [®]	CL6
LFIC 6-pin Disposable Core [®]	CT6D
LFIC 6-pin with Temporary Construction Core (Red)	CT6R
LFIC 6-pin with Temporary Construction Core (Blue)	CT6B
LFIC 6-pin with Temporary Construction Core (Green)	CT6G
LFIC 7-pin [®]	C7
LFIC 7-pin Less Core [®]	CL7
LFIC 7-pin Disposable Core [®]	CT7D
LFIC 7-pin with Temporary Construction Core (Red)	CT7R
LFIC 7-pin with Temporary Construction Core (Blue)	CT7B
LFIC 7-pin with Temporary Construction Core (Green)	CT7G
SFIC	
SFIC 6-pin [®]	C6S
SFIC 6-pin with Temporary Construction Core (Blue) [®]	CT6SB
SFIC 6-pin with disposable temporary core [®]	CT6SD
SFIC 6-pin less core [®]	CLS6
SFIC 7-pin [®]	C7S
SFIC 7-pin with Temporary Construction Core (Blue)	CT7SB
SFIC 7-pin with disposable temporary core [®]	CT7SD
SFIC 7-pin less core [®]	CLS7
Security	
Security [®]	HS
Security LFIC [®]	CHS
Access 3[®]	
Access 3 [®] Patented Fixed Core [®]	AP
Access 3 [®] Security Fixed Core [®]	AS
Access 3 [®] High Security Fixed Core [®]	AHS
Access 3 [®] Patented LFIC [®]	ACP
Access 3 [®] Security LFIC [®]	ACS
Access 3 [®] High Security LFIC [®]	ACHS
Pyramid	
Pyramid Security Fixed Core [®]	PS
Pyramid High Security Fixed Core [®]	PHS
Pyramid Security LFIC [®]	PCS
Pyramid High Security LFIC [®]	PCHS
Pyramid LFIC Less Core [®]	CLP
Pyramid with Temporary Construction Core [®]	CTP
Pyramid Disposable Core [®]	CTPD

[®] Indicates availability with ML200VR lockset

*Not available with 52 function

Cylinder and Keying (cont)

Description	Specify
Keying and Keys	
Keyed Random [®]	KR
Construction Master Keyed (not available for Pyramid) [®]	CMK
2 keys per lock	(standard)
More than 2 keys	KY# (e.g., KY6)
Visual key control (VKC)[®]	
No bitting or keyset stamping on keys	VKC0
Keys only	VKC1
Cylinders and keys (not for AS, AHS, ACS, ACHS, HS, CHS, PHS or PCHS)	VKC2
Cylinders only (not for AS, AHS, ACS, ACHS, HS, CHS, PHS or PCHS)	VKC3
Concealed key control (CKC)[®]	
CKC cylinders with VKC keys	CKC2
CKC cylinders only (not for AS, AHS, ACS, ACHS, PHS, PCHS)	CKC3

1. Not available with ML2029.

2. Not available for ML2017, ML2029 or ML2032 x MR, ML2000HS or ML2000VR.

Door Height

Door Height	Specify
7'0"	(standard)
7'2"	H0702
7'6"	H0706
8'0"	H0800
9'0"	H0900
10'0"	H1000

Note: Maximum adjustment of rod length is 3/4"

Door Thickness

Door	Specify
1-3/4" (44mm)	(standard)
2" (51mm)	D200
2-1/4" (57mm)	D214

Quick Codes

MP9800 Series

Finish

Description	Specify
Bright Brass	605
Satin Brass	606
Bright Bronze	611
Satin Bronze	612
Dark Oxidized Satin Bronze, oil rubbed	613
Dark Oxidized Satin Bronze Equivalent	613E
Bright Nickel Plated	618
Satin Nickel Plated	619
Bright Chromium Plated	625
Satin Chromium Plated	626
Satin Chromium Plated with MicroShield®	626C
Bright Stainless Steel	629*
Stain Stainless Steel	630*
Black Suede Powder Coat	BSP

*Only available with Piet Collection

Lock/Cylinder Finish

Lock	Cylinder/Core*
605,606,611,612,613,613E,722	606
618,619,625,626,626C,629,630,630C	626
BSP	BSP

*Finish when cylinder provided with lock

Handing

Hand	Specify
Right Hand	RH
Right Hand Reverse	RHR
Left Hand	LH
Left Hand Reverse	LHR

Architectural Specifications

- Multi-Point Locking Solutions shall be MP9800 Series as manufactured by Corbin Russwin, Berlin, CT.
- Multi-Point Locking Solutions shall be listed by Underwriters Laboratories and bear the UL label in full compliance with NFPA 80. Multi-Point Locking Solutions for fire labeled doors shall be UL listed as "Fire Hardware".
- Rods shall be retracted in one operation by dual mounted lever controls with a complete range of functions, including electro-mechanical, on the secure side of the door.
- The lock shall also be available as a single latching lock with top latching only, eliminating the bottom strike.
- Lever trim shall be available in finishes and designs to match that of the specified locksets.
- Sargent 7000 Multi Point is the only approved substitute.
- Multi-point locks shall have a five year limited warranty.

Miscellaneous Options

Description	Specify
Torx® head screws	M04
Knurling outside and inside	M20 ²
Knurling outside only	M21 ²
Knurling inside only	M22 ²
Abrasive coat outside and inside	M23
Abrasive coat inside only	M24
Abrasive coat outside only	M25
Less bottom vertical rod	M55
Windstorm	M107
Aluminum Door	MPAD ¹
Rectangular Back Plate (Required for Wood Door - MPWD)	MPER
Back Plate (Required for Wood Door - MPWD)	MPES
Lever Hold Back	MPHB
Wood Door	MPWD ¹
Aux Control (Classroom)	AUX155
Aux Control (Storeroom)	AUX159

1 Must specify Quick Code when ordering for aluminum or wood doors

2 All levers provided in a powder coat finish will be supplied with an abrasive coating

Electrified Options

Description	Specify
Latchbolt Monitoring	M91
O/S Lever Monitoring	M93
I/S Lever Monitoring	M92
Electric Latch Retraction	MELR



ED5000 Series

Product Catalog

Experience a safer
and more open world

Rim Features

ED5000 Series

- ED5200** Panic-Listed Rim Exit Device
ED5200A 3-Hour Fire-Listed Rim Exit Device
ED5202 Panic-Listed Rim Double Cylinder Exit Device
ED5202A 3-Hour Fire-Listed Rim Double Cylinder Exit Device



Features

Handing

Standard device is non-handed.
 Double Cylinder Device is Handed.
 Lever trim is handed.

Bar Length

Easily field cut to size.
 Standard: 36" (914mm) bar fits 30" - 36"
 (762mm-914mm) door.
 Optional: 24" (610mm) bar fits 24" (610mm)
 door; specify W024.
 Optional: 48" (1219mm) bar fits 36" -48"
 (914mm-1219mm) door; specify W048.

Door Thickness

1-3/4" (44mm) standard.
 Optional: 2" (51mm); specify D200.
 Optional: 2-1/4" (57mm); specify D214.

Stile

Minimum width 4-1/2" (114mm).

Latchbolt

3/4" (19mm) throw, stainless steel pullman-
 type with stainless steel deadlocking latch.

Materials

Heavy-duty cold-forged steel chassis; heavy-
 gauge steel mechanisms, electroplated
 for corrosion resistance; finished parts are
 brass, bronze or stainless steel; stainless steel
 springs; nylon bearings.

Projection

3-1/4" (83mm) active, 2-3/4" (70mm) dogged.

Dogging

Standard on panic devices; single-point 1/4
 turn hex key dogging.
 Optional: less dogging, specify M51.
 Optional: cylinder dogging; specify M52.
 Optional: electric dogging; specify M97.
 Mechanical dogging not available on fire-
 rated devices.

Fasteners

Standard on panic devices: machine screws
 and wood door fasteners. Standard on fire-
 rated devices: sex nuts and bolts. Optional
 on panic devices: sex nuts and bolts for use
 on wood, composite, or unreinforced metal
 doors; specify M54. Optional wood screws for
 use on approved fire-rated solid wood or wood
 core doors. Specify M64.

Strike

Surface-mounted 3/8" (10mm) diameter roller
 strike, complete with positive locking plate and
 shims, assuring low friction relocking for a long,
 trouble-free life.

Functions and Trims

Through-bolted lever, pull and thumbpiece
 trims available with wide range of functions;
 see Trims and Functions, pages 18-25.

Cylinders

Cylinder not included unless specified. See
 Quick Codes, page 54.

Removable Mullion

See Mullions, page 49.

Shim Kit

Optional for mounting device over raised vision
 light molding; specify M58.

Applications and Listings

See page 4.

Warranty

Five-year limited.

Certification/Compliance

ANSI

Meets A156.3, Type 1, Grade 1.
 Meets A117.1 Accessibility Code.

UL/cUL

All devices listed for safety as panic hardware;
 devices comply with UL 305 standards for panic
 hardware. Three-hour fire-rated devices listed
 as fire exit hardware for A label and lesser class
 4' x 8' single or 8' x 8' double doors; UL symbol
 on active case cover indicates listing.

Any retrofit or other field modification to
 a fire rated opening can potentially impact
 the fire rating of the opening, and Corbin
 Russwin, Inc. makes no representations or
 warranties concerning what such impact may
 be in any specific situation. When retrofitting
 any portion of an existing fire rated opening,
 or specifying and installing a new fire-rated
 opening, please consult with a code specialist
 or local code official (Authority Having
 Jurisdiction) to ensure compliance with all
 applicable codes and ratings.

California State Reference Code

This product has been approved by the
 California State Fire Marshal pursuant to
 section 13144.1 of the California Health and
 Safety Code.

NFPA

All exit devices comply with NFPA 101 Life
 Safety Code. All fire-rated devices comply
 with NFPA 80 Fire Doors and Windows.

ADA

Exit devices, lever trims and pulls comply
 with Americans with Disabilities Act.

Finishes

BHMA 605	Bright Brass
BHMA 606	Satin Brass
BHMA 611	Bright Bronze
BHMA 612	Satin Bronze
BHMA 613	Oxidized Bronze, oil rubbed, available lacquered
613E	Dark Oxidized Satin Bronze Equivalent
BHMA 618	Bright Nickel Plated
BHMA 619	Satin Nickel Plated
BHMA 625	Bright Chromium Plated
BHMA 626 ¹ (Trim only)	Satin Chromium Plated
626C ²	Satin Chromium Plated with MicroShield®
BHMA 629	Bright Stainless Steel
BHMA 630	Satin Stainless Steel
630C ²	Satin Stainless Steel with MicroShield®
722	Black oxidized bronze,oil rubbed
BSP	Black Suede Powder Coat
WSP	White Suede Powder Coat

1. Contact factory for devices required in BHMA 626
2. Finish available with MicroShield® antimicrobial coating.

Rim Features

ED5000 Series

ED5200 and ED5200A Rim Exit Devices

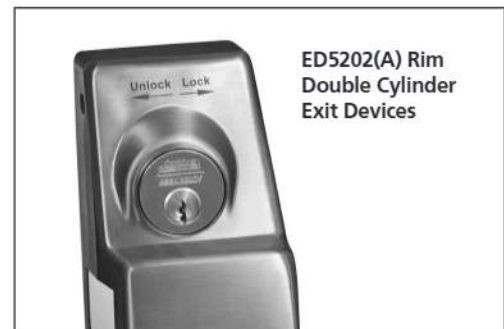
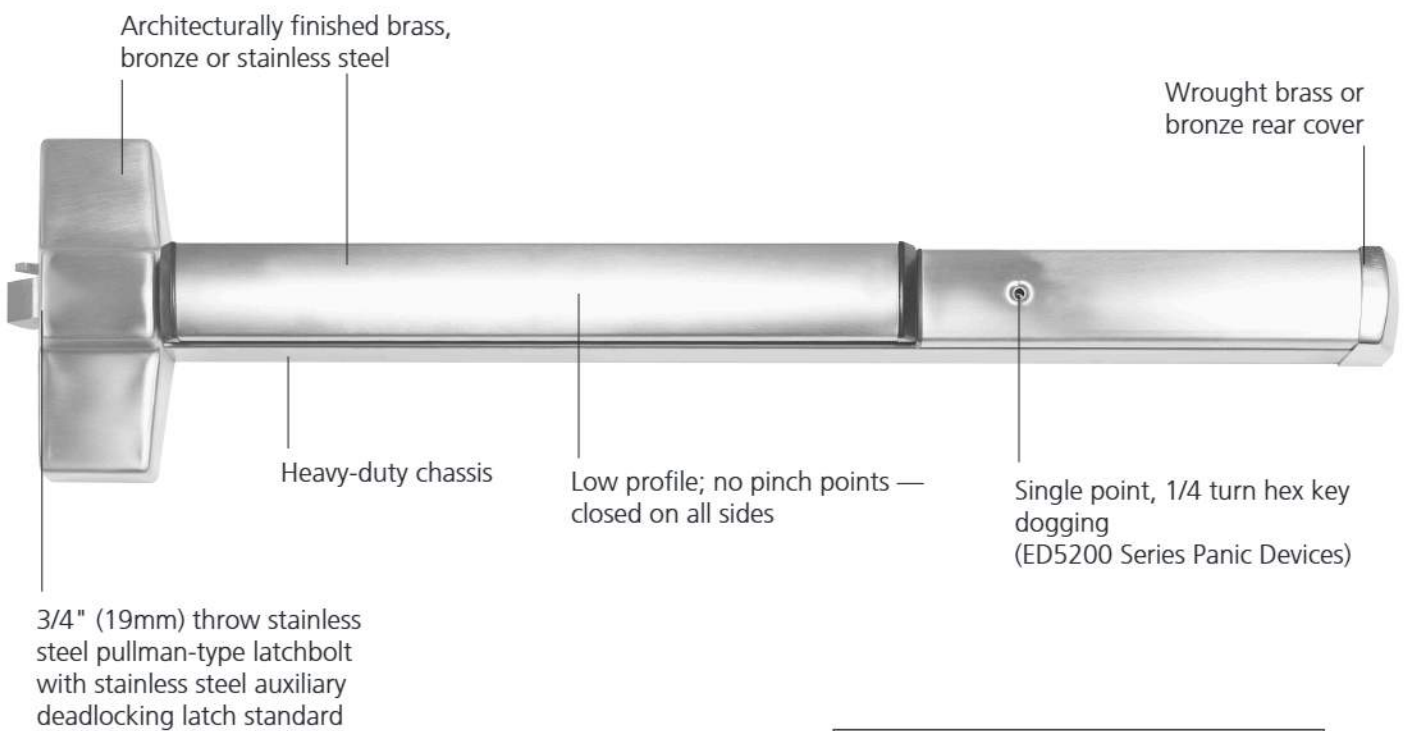

Surface Vertical Rod Features

ED5000 Series

ED5470 Panic-Listed Surface Vertical Rod Exit Device ED5470B 1-1/2 Hour Fire-Listed Surface Vertical Rod Exit Device

Features

Handing

Device is handed but easily field reversible.

Lever trim is handed.

Bar length

Easily field cut to size.

Standard: 36" (914mm) bar fits 30" - 36" (762mm-914mm) door.

Optional: 24" (610mm) bar fits 24" (610mm) door; specify W024.

Optional: 48" (1219mm) bar fits 36" - 48" (914mm-1219mm) door; specify W048.

Door Thickness

1-3/4" (44mm) standard.

Optional: 2" (51mm); specify D200.

Optional: 2-1/4" (57mm); specify D214.

Stile

Minimum width 4-1/2" (14mm).

Door Height

Standard top rod for 7' door.

All top rods easily field cut to size.

Optional door heights up to 10' available; see Quick Codes, page 56.

Latchbolt

Top: 3/4" (19mm) throw, stainless steel, pullman-type with automatic deadlatching. Bottom: 5/8" (16mm) throw deadbolt, held retracted during door swing.

Vertical Rods

1/2" O.D. tubular brass, bronze or stainless steel with rod guides.

Less Bottom Rod

Optional on ED5470 & ED5470B devices only; specify M55.

Heat Activated Door Bolt (Popper)

Standard on all fire-rated devices with M55 option (less bottom rod).

Materials

Heavy-duty cold-forged steel chassis; heavy-gauge steel mechanisms, electroplated for corrosion resistance; finished parts are brass, bronze or stainless steel; stainless steel springs; nylon bearings.

Projection

3-1/4" (83mm) active, 2-3/4" (70mm) dogged.

Dogging

Standard on panic devices; single-point 1/4 turn hex key dogging. Optional: less dogging, specify M51. Optional: cylinder dogging, specify M52. Optional: electric dogging; specify M97. Mechanical dogging not available on fire-rated devices.

Fasteners

Standard on panic devices: machine screws and wood door fasteners. Standard on fire-rated devices: sex nuts and bolts. Optional on panic devices: sex nuts and bolts for use on wood, composite, or unreinforced metal doors; specify M54. Optional wood screws for use on approved fire-rated solid wood or wood core doors. Specify M64.

Strike

Top: surface mounted interlocking.

Bottom: flush mounted.

Optional strikes available; see Options and Accessories, page 51.

Functions and Trims

Through-bolted lever, pull and thumbpiece trims available with wide range of functions; see Trims and Functions, pages 18-25.

Cylinders

Cylinder not included unless specified. See Quick Codes, page 54.

Shim Kit

Optional for mounting device over raised vision light molding; specify M58.

Applications and Listings

See page 4.

Warranty

Five-year limited.

Certification/Compliance

ANSI

Meets A156.3, Type 2, Grade 1.

Meets A117.1 Accessibility Code when ordered with M55 option only.

UL/cUL

All devices listed for safety as panic hardware; devices comply with UL 305 standards for panic hardware. 1-1/2 hour fire-rated devices listed as fire exit hardware for B label and lesser class 8' x 10' double doors; UL symbol on active case cover indicates listings.

Any retrofit or other field modification to a fire rated opening can potentially impact the fire rating of the opening, and Corbin Russwin, Inc. makes no representations or warranties concerning what such impact may be in any specific situation. When retrofitting any portion of an existing fire rated opening, or specifying and installing a new fire-rated opening, please consult with a code specialist or local code official (Authority Having Jurisdiction) to ensure compliance with all applicable codes and ratings.

California State Reference Code

This product has been approved by the California State Fire Marshal pursuant to section 13144.1 of the California Health and Safety Code.

NFPA

All exit devices comply with NFPA 101 Life Safety Code.

All fire-rated devices comply with NFPA 80 Fire Doors and Windows.

ADA

Exit devices with M55 option, lever trims and pulls comply with Americans with Disabilities Act.

Finishes

BHMA 605	Bright Brass
BHMA 606	Satin Brass
BHMA 611	Bright Bronze
BHMA 612	Satin Bronze
BHMA 613	Oxidized Bronze, oil rubbed, available lacquered
613E	Dark Oxidized Satin Bronze Equivalent
BHMA 618	Bright Nickel Plated
BHMA 619	Satin Nickel Plated
BHMA 625	Bright Chromium Plated
BHMA 626 ¹ (Trim only)	Satin Chromium Plated
626C ²	Satin Chromium Plated with MicroShield®
BHMA 629	Bright Stainless Steel
BHMA 630	Satin Stainless Steel
630C ²	Satin Stainless Steel with MicroShield®
722	Black oxidized bronze, oil rubbed
BSP	Black Suede Powder
WSP	White Suede Powder Coat

1. Contact factory for devices required in BHMA 626
2. Finish available with MicroShield® antimicrobial coating.

Surface Vertical Rod Features

ED5000 Series

ED5470 and ED5470B Surface Vertical Rod Exit Devices

3/4" (19mm) throw deadlocking
stainless steel latchbolt



Architecturally finished brass,
bronze or stainless steel



Low profile; no pinch
points – closed on all
sides



Heat-activated door bolt
(Popper) – Used when bottom
rod is omitted from fire exit
devices (M55).

**ED5470B
M55 (Less Bottom Rod)**

Wrought brass or
bronze rear cover



Heavy-duty chassis

Single point 1/4 turn hex key dogging
(ED5470 Series Panic Devices)

5/8" (16mm) throw
deadbolt

Functions

ED5000 Series

Pull and Thumbpiece Trim





































Rim/ SecureBolt® ED5200(A) ED5200S(A)		Surface Vertical Rod ED5400(A) ED5470(B)		Concealed Vertical Rod ED5800(A) ED5860(B)		Type	ANSI No.	Function Description
Inside	Outside	Inside	Outside	Inside	Outside			
						Exit Only	01	Exit only; no trim.
						Dummy	02	Entrance by trim when actuating bar is dogged down.
						Nightlatch	03	Entrance by trim when latchbolt is retracted by key.
						Classroom*	05	Entrance by thumbpiece. Key locks or unlocks thumbpiece.
						Passage	15	Entrance by trim when latch is retracted by thumbpiece. Thumbpiece is always active, no cylinder.
						Storeroom (Thumbpiece Active)	06	Entrance by thumbpiece only when released by key. Key removable only when locked.

*Classroom function trims can be converted to Storeroom function by a simple field adjustment.

Functions

ED5000 Series

Lever Trim

Rim/ SecureBolt® ED5200(A) ED5200S(A)		Surface Vertical Rod ED5400(A) ED5470(B)		Concealed Vertical Rod ED5800(A) ED5860(B)		Type	ANSI No.	Function Description
Inside	Outside	Inside	Outside	Inside	Outside			
						Exit Only	01	Exit only; no trim.
						Dummy	02	Entrance by trim when actuating bar is dogged down.
						Nightlatch	03	Entrance by trim when latchbolt is retracted by key.
						Classroom*	08	Entrance by lever. Key locks or unlocks lever.
						Passage	14	Entrance by trim when latchbolt is retracted by lever. Lever always active, no cylinder.
						Storeroom (Grip Active)	09	Entrance by lever only when released by key. Key removable only when locked.

*Classroom function trims can be converted to Storeroom function by a simple field adjustment.

Copyright © 2000-2025, ASSA ABLOY Access and Egress Hardware Group, Inc. All rights reserved. Reproduction in whole or in part without the express written permission of ASSA ABLOY Access and Egress Hardware Group, Inc. is prohibited. Patent pending and/or patent www.assaabloyds.com/patents.

Experience a safer
and more open world

Heavy-Duty Trims & Functions



ED5000 Series

Rim, SecureBolt®, Vertical Rod

Features:

- Free Wheeling vandal-resistant design
- Beveled edges

- Through-bolted to exit device
- Flush cylinder with 6-pin cylinder applications
- 5-year limited warranty

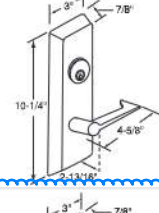
Pull Trim Design	Trim/Function				
	Passage ANSI No. 14	Dummy ANSI No. 02	Classroom ANSI No. 08	Nightlatch ANSI No. 03	Storeroom ANSI No. 09
 <p>Armstrong A9 Lever: Cast Escutcheon: Forged Cylinder: Rim</p> 	A910ET	A950ET	A955ET ¹	A957ET ²	A959ET ¹
 <p>Citation C9 Lever: Cast Escutcheon: Forged Cylinder: Rim</p> 	C910ET	C950ET	C955ET ¹	C957ET ²	C959ET ¹
 <p>Dirke D9 Lever: Cast Escutcheon: Forged Cylinder: Rim Handed: Specify RHR or LHR</p> 	D910ET	D950ET	D955ET ¹	D957ET ²	D959ET ¹
 <p>Essex E9 Lever: Cast Escutcheon: Forged Cylinder: Rim</p> 	E910ET	E950ET	E955ET ¹	E957ET ²	E959ET ¹
 <p>Lustra L9 Lever: Cast Escutcheon: Forged Cylinder: Rim</p> 	L910ET	L950ET	L955ET ¹	L957ET ²	L959ET ¹
 <p>Newport N9 Lever: Cast Escutcheon: Forged Cylinder: Rim</p> 	N910ET	N950ET	N955ET ¹	N957ET ²	N959ET ¹

1. Classroom function trims can be converted to Storeroom function by a simple field adjustment.
2. Not recommended for use on ED5400 or ED5800 series exit devices.

Utility Trims and Functions







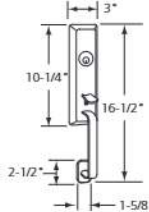

ED5000 Series

Rim, SecureBolt®, Vertical Rod

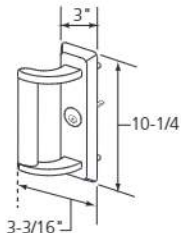
Features:

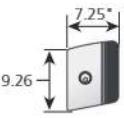
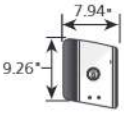
- Free Wheeling vandal-resistant design
- Beveled edges

- Through-bolted to exit device
- Flush cylinder with 6-pin cylinder applications
- 5-year limited warranty

Pull Trim Design		Trim/Function					
		Passage ANSI No. 14/15	Dummy ANSI No. 02	Classroom ANSI No. 05/08	Nightlatch ANSI No. 03	Storeroom ANSI No. 06/09	
	TH900 Trim Pull: Extruded Escutcheon: Forged Cylinder: Rim Projection: 2-11/16"		TH910ET	TH950ET	TH955ET ¹	TH957ET ²	TH959ET ¹
	Offset Pull P9  Pull: Extruded Escutcheon: Forged Cylinder: Rim Handed. Specify RHR or LHR		N/A	P950ET	N/A	P957ET ²	N/A
	VT9 Trim  Plate: Formed Stainless Steel Cylinder: Rim Handed: Specify RHR or LHR Available in 630 finish only.		N/A	VT950ET	N/A	VT957ET ²	N/A
			N/A	VTL950ET ³	N/A	VTL957ET ^{2,3}	N/A
	Key Only K1  Note: Available with cylinder option only. Ex: K157 x 6P.		N/A	N/A	N/A	K157ET ⁴	N/A

1. Classroom function trims can be converted to Storeroom function by a simple field adjustment.
2. Not recommended for use on ED5400 or ED5800 series exit devices.
3. VTL has a lip that covers door gap and protects the latch.
4. Not available in 625 or 626 finish. Supplied in 629 or 630 respectively.

Electrified Exit Devices

ED5000 Series

Electrified Exit Devices

The Corbin Russwin ED5000 series electrified exit devices offer a complete range of options that may be integrated into the monitoring security and alarm systems of most buildings. The continuum of appearance is maintained, as well as the security and function of the ED5000 series mechanical exit device.



List No.	Exit Device Description	Available options										
		MELR	M61	M91	M92	M93	M97	SAF	SEC	D	9903	9905
ED5200 (A)	Rim Exit Device	x	x	x	x	x	x			x	x	x
ED5200S (A)	Rim SecureBolt® Device	x	x	x	x	x	x			x	x	x
ED5400 (A)	Surface Vertical Rod	x	x	x	x	x	x			x	x	x
ED5470 (B)	Surface Vertical Rod	x	x	x	x	x	x			x	x	x
ED5600 (A)	Mortise Exit Device	x	x	x	x		x	x	x	x		
ED5800 (A)	Concealed Vertical Rod	x	x	x	x	x	x			x	x	x
ED5860 (B)	Concealed Vertical Rod	x	x	x	x	x	x			x	x	x

Electrified Hardware Option Descriptions

MELR	Motorized Electric Latch Retraction
M61	Alarm Option
M91	Bolt Monitor
M92	Touchbar Monitor
M93	Trim Monitor
M97	Electric Dogging
SAF	Fail Safe Operation
SEC	Fail Secure Operation
D*	Delayed Egress ²
9903	Fail Safe Electrified Trim
9905	Fail Secure Electrified Trim

* Add as suffix to exit device.
Example: ED5200D x 630 x RHR

Note 1: The following options cannot be ordered together on the same device:

- (MELR or M97) & D
- MELR x M97
- M52 x M97
- M97 x M107
- (M61 or M92) & D
- M61 x M92
- M61 x MELR
- M61x M52
- M52 & D
- ED5600 x M91 & M93
- (ED5600 SAF or SEC) x (M91 or M93)
- Surface vertical rod exit devices with M61 x M91, M92 or M93.
- (MELR or M97) x W024
- (ED5200 X 5CH) x MELR

Note 2: When ordering a surface vertical rod exit device with the D option, rod and latch guards (provided by other) must be used.

Note 3: M88 (NFPA30) M89 (BOCA-15) and M90 (BOCA-30) are available only as options for suffix "D" Delayed Egress Exit Devices.

Electrified Exit Devices

ED5000 Series

Electric Latch Retraction - MELR

The Motorized Electric Latch Retraction (MELR) exit device provides remote-controlled latch retraction that delivers quiet, smooth operation for convenient, hassle-free egress. Easily installed in new applications and available as retrofit rail kit assemblies for field updates, the MELR features maintenance-free design with few moving parts using 86% less power consumption during retraction than solenoid devices. Plus, MELR is powered by a standard power supply, simplifying installation and increasing system design flexibility.

Application

SecureBolt® Exit Devices
Rim Exit Devices
Surface Vertical Rod Exit Devices
Concealed Vertical Rod Exit Devices
Mortise Exit Devices

Listings

UL listed for both Panic and Fire Exit Hardware. Windstorm rated with M107 option.

Bar Length/Door Width

Easily field cut to size.
Standard: 36" (914mm)* bar fits 34"-36"

(762mm-914mm) door.

*Bar fits 34"-36" when equipped with MELR Option.

Optional: 48" (1219mm)* bar fits 36"-48" (914mm-1219mm) door; specify W048.

*bar fits 39"-48" when equipped with MELR Option

Electrical Specifications

24VDC (LSP-12-24) regulated/filtered power supply. Requires 1A per device

Motor Driven Latch Retraction

.65A amp max during retraction
.2 amp holding-continuous duty

Device bolts remain retracted for as long as the device is energized.

Removal of power returns the device to the life safety, self-latching mechanical mode.

Interfaces with central or local fire alarm system, automatic door operators, access control systems, security alarm systems, and blow open door systems.

Amount of rail retraction is automatically controlled by controller PC board; system actively monitors position and speed and adjusts itself.

Timer

Digital retraction timer (0-20 seconds) or set to power mode for access control systems.

Hinges

Standard electric hinge. No special power transfer required.

Note: This feature is not available with Electric Dogging (M97) or delayed egress (D) on the same device.

The MELR feature is not available when combined with the Exit Device Alarm (M61), Electric Dogging (M97), or Delayed Egress (D) options.

Warranty

5 years

How to Order

Specify Quick Code MELR.



Electrified Exit Devices

ED5000 Series

Delayed Egress Exit Device - D

The delayed egress option provides additional security and safety in a strong line of exit hardware. The delayed egress exit device is an electromechanical device used to secure interior or exterior openings.

Operation

The exit door is normally closed and latched. The Delayed Egress Exit Device "D" secures the door in the locked mode with the solid Red LED indicating locked mode status. Depressing the pushpad for less than 3 seconds will sound the nuisance beep without initiating the alarm. Depressing the pushpad for 3 seconds or longer will initiate an irreversible local audible beeping tone and a visual amber indicator until the device releases. The person depressing the exit bar is denied egress for 15 or 30 seconds and security personnel are alerted. After the delay time of 15 or 30 seconds the device releases, the LED changes to Green, and the alarm changes to a steady tone which continues to alarm until manually reset by key. The remote monitoring contact outputs can be used to alert security personnel.

Note: The 15-second time delay is standard. 30-second time delay is optional (may be accepted by local jurisdiction).

Applications

- For use on hollow metal, wood or composite interior or exterior doors.
- Available for rim, SecureBolt®, surface vertical rod, concealed vertical rod and mortise panic and fire-rated exit devices. For surface vertical rod exit devices, rod and latch guards must be used. Consult factory for more information.
- Complies with NFPA 101 "Code For Safety To Life From Buildings And Structures" by National Fire Protection Association.
- BOCA options available to comply with National Building Code requirements. BOCA option is not suitable for installations in accordance with NFPA 101.



- 1-3/4" (45mm) door thickness standard; 2" (51mm) and 2-1/4" (57mm) optional; specify D200 or D214 when ordering.
- Standard 36" device fits 36" doors only. Device cannot be cut less than 36".
- Option W048 fits doors 42" – 48". Devices cannot be cut less than 42".

Listing

- UL/cUL Listed
 - Fire Exit Hardware (GXHX/GXHX7)
 - Controlled Exit Panic Device (FUKD/FUKD7)
 - Special Locking Arrangements (FWAX/FWAX7)
- BHMA (ANSI A156.3 and ANSI A156.24) Directory of Certified Exit Devices

Specifications

Input Voltage: 24VDC (+/- 10%) Regulated and filtered.

Power Consumption

- Standard Device: 500 mA
- Device with Electric Trim Control: 1.5 Amp
- Mortise Device with "Safe" or "Secure" option: 1.5 Amp

Standard Features

Key Switch Operation:

- Normal: The system is armed by applying power to the device (solid Red LED). Depressing the pushpad for more than the nuisance delay time starts the exit delay cycle.
- Bypass: Turning the key switch clockwise to the bypass position allows immediate egress without alarming. The bar functions as a standard exit device. (Red LED flashes slow.)
- Reset/Delay: Used to reset device after the factory set 15 or optional 30 second delay cycle has timed out. If the device is armed, turning the key switch counterclockwise to

the reset mode will release the device without alarm for egress and will rearm after 5, 10 (default), 20 or 40 seconds. (Red LED flashes quickly.)

- Alarm Strength: 85 Db @ 10'.

Local Visual Status Indicator:

- RED: The exit device is secure and the delayed egress circuitry is energized.
- AMBER: The egress cycle has started, indicated by an irreversible local audible beeping tone.
- GREEN: Exit device is in alarm and has released.

Nuisance Delay Time:

With 3 second (default) setting depressing the push bar for less than 3 seconds sounds an audible beep without activating the irreversible alarm sequence. (Nuisance Delay Times are dip switch selectable to immediate, 1, 2, or 3 (default) seconds on the control board.

Internal Alarm Siren:

When the exit device is armed, depressing the push pad initiates the internal 85db alarm siren.

Door Position Switch (DPS) Control

Board input: Allows external DPS wiring to control board for higher security. Alarm sounds when the DPS contacts open when the door is forced open.

Remote Control Inputs:

- Remote Reset: Accepts a momentary contact (keyswitch, pushbutton, etc.) to reset the unit during alarm or allows momentary egress selectable 5, 10 (default), 20 or 40 seconds when the unit is armed.
- Remote Bypass: Accepts a momentary contact to put the unit in a maintained bypass operation. The exit device functions as a standard device.

Electrified Exit Devices

ED5000 Series

Alarm Outputs:

Contacts change only during alarm status. Alarm Relay Output contacts change state when device delay cycle has started (Alarm). Contacts are selectable for Normally Open (N.O.) or Normally Closed (N.C.) using the 2-pin jumper on the control board. N.O. is default setting. One set of contacts changes when device delay cycle has started (Alarm). Another set of contacts change state when device has released (Secure). Secure Relay Output has two sets of contacts (N.O. and N.C.). The Alarm Relay and Secure Relay contacts are SPDT type, rated 1A @24VDC.

Rearm After Closing (RAC)

Works in conjunction with an external DPS wired to the Control Board. Field selectable settings:

Setting 1: If the door is open beyond the momentary egress or remote reset time the device will Alarm.

Setting 2: If the door is open beyond the momentary egress or remote reset time the device will remain in egress mode indefinitely until the door closes (will not Alarm).

Door Sign:

Door sign per code included.

How to Order

Specify "D" suffix after device.
Example: ED5200SD

Options

Bolt Position Monitor M91:

SPDT (Single Pole Double Throw) switch that monitors the position of the latchbolt or vertical rods. To order, specify M91.

Outside Trim Monitor M93:

Used when outside trim is desired to be used with an external door position switch (by others) input. This switch will allow Bypass (disarms device) when the trim is used for ingress. The device requires setting after entry by means of the keyswitch on the device or a remote switch. To order, specify M93.

Note: If an external DPS is not used, standard trim will allow entry without affecting the device in an armed mode. The device will only be affected when the touchbar is depressed.

Mortise Electric Trim Control SAF/SEC:

The mortise delayed egress exit device can be ordered with Fail Safe or Fail Secure outside trim operation. In a fire condition the Fail Safe trim will release for entry. When access control is used the Fail Secure trim allows entry by means of a remote card reader, keyswitch, pushbutton, etc. To order, specify SAF or SEC.

Note: The trim will open the door without affecting the device in an armed mode if a door position switch (by others) is not used.

30-Second Delay M88:

Device released after 30 seconds. The device will provide visual and audible indication that the delayed egress cycle has been activated. After the device has been released, the siren changes to a steady tone which continues until reset by keyswitch or remote inputs on the device. Required signage must indicate 30 seconds for release. To order, specify M88.

Note: 30 seconds may be accepted by local jurisdiction.

BOCA 15-Second Delay M89:

BOCA 30-Second Delay M90:

Upon pressing the touchpad for 3 seconds or more, the device will sound an audible beeping tone and release for egress after a total of 15 or 30 seconds, sounding the alarm. When the door is re-secured, the device will automatically rearm after 30 seconds. A door position switch (by others) is required for this option. Required signage must indicate 15 or 30 seconds for release. To order, specify M89 for BOCA 15 seconds or M90 for BOCA 30 seconds.

Note: BOCA option is not suitable for installations in accordance with NFPA 101.

Required Accessories

Power Supply:

A regulated and filtered power supply with a Fire Alarm interface is required. 1 Amp minimum @ 24VDC per device. Special options will require more amperage. Consult factory.

To order, specify:

- LSP-12-24 – 1 Amp @ 24VDC power supply (controls 1 "D" device) or;
- LSP-12-24 – 1.5 Amp @ 24VDC power supply (controls 2 "D"s or 1 "D" with SAF or SEC options)

Power Transfer:

Allows the power to make the transition from frame to door without pinching or removal of insulation. Optional power transfer: EPTL – concealed transfer for up to and over 120° swing doors. To order specify Part No. 704F28. Consult catalog for additional recommended power supplies and accessories.

Trims

Utilizes heavy-duty and utility trims. See Trims and Functions, pages 28-35.

Cylinders

Utilizes a 1-1/8" mortise cylinder; A02 cam. Cylinder not included unless specified. See Quick Codes, page 54.

Warranty

Exit devices and heavy-duty trim carry a five-year limited warranty. Electronic components carry a two-year limited warranty.



Refer to McKinney Power Transfer Device catalog for ElectroLynx options

ElectroLynx® Power Transfer Device Options		
Hinge	External DPS	Options
QC8	Not required	None
QC12	Required	M91, or M93, or Fail Safe/Secure Options

Electrified Exit Devices

ED5000 Series

Electrically Controlled Heavy-Duty Trim

Electrically controlled trim provides electric locking and unlocking of the 900 Series heavy-duty lever trim. It easily retrofits into existing applications and is ideal for door control.

Advantages

- Available in Fail Safe or Fail Secure operation
- Features EcoFlex®
- Operates from 12-24 VDC
- Internal rectifier accepts AC or DC voltage
- Key override (specify cylinder)
- Plug connector with 4' wire lead (Exit device can be used as the wire raceway)
- Utilize Mortise Cylinder with A02 cam
- M99 Trim Gasket for exterior applications included

Applications

- ED5200(A) Rim
- ED5200S(A) SecureBolt®
- ED5400(A) Surface Vertical Rod
- ED5470(B) Surface Vertical Rod
- ED5800(A) CVR
- ED5860(B) CVR

Trim

Utilizes all 900 series trim lever designs including the Muséo® and Vineyard™ Collections

Electrical Specifications

- Actuator Draw = 400mA inrush / 15mA continuous @12VDC / 24VDC
- Security Monitor Switch (M98): 4 AMP @ 250VAC

Door Thickness

1-3/4" (44mm) standard.
Optional: 2" (51mm); specify D200.
Optional: 2-1/4" (57mm); specify D214.

Options

- M98 – Security Monitor. A SPDT switch that monitors the position of the motor actuator (lock and unlock status).

Cylinder

Cylinder not included unless specified. See Quick Codes, page 54.



Electrically Controlled Heavy-Duty Trim

How to Order

N9903 626 RHR M98, 6P

Functions

Fail Safe

The x9903 trim is locked when power is on and unlocked when power is off.

	Function Description
x9903 (Fail Safe)	<ul style="list-style-type: none"> • Lever is locked when power is on • Power off allows entry from trim
	<ul style="list-style-type: none"> • Inside device is always active for egress • Mechanical key override (09 Function – Key allows lever to retract latch bolt. Key can only be removed in locked position.)

Fail Secure

The x9905 trim is locked when power is off and unlocked when power is on.

	Function Description
x9905 (Fail Secure)	<ul style="list-style-type: none"> • Lever is locked when power is off • Power on allows lever activation for entry
	<ul style="list-style-type: none"> • Inside device is always active for egress • Mechanical key override (09 Function – Key allows lever to retract latch bolt. Key can only be removed in locked position.)

x = Lever trim design - Standard, Vineyard™ and Muséo®

Electrified Exit Devices

ED5000 Series

EPTL

Concealed power transfer for over 120° swing doors. Installs in door and frame edges. Supports wires up to .25" (6mm) thick, and works with doors hung with butt hinges, continuous hinges and pivots. To order, specify Part No. 704F288.



EPTL

Monitors - M91, M92, M93

Operation

Monitors are used to indicate the authorized and unauthorized use of an opening or to signal and control other opening hardware, such as magnetic locks. Each monitoring device is equipped with one internal single-pole double-throw (SPDT) switch per monitor.

Bolt Position Monitoring - M91

Provides indication of the position of the latch bolt. Used with security systems to monitor the latch bolt; also used to activate automatic door operators upon latch retraction.

Application

See chart on page 36.

Listings

UL listed for both Panic and Fire Exit Hardware.

Electrical Specifications

2 Amps @ 28VDC
SPDT contacts

Ordering

Specify Quick Code M91.

Touchbar Monitoring - M92

Request to Exit - REX

Provides indication of the pushpad being depressed. Used as a request to exit to shunt alarm systems, release electromagnetic locks or monitor egress.

Application

See chart on page 36.

Listings

UL listed for both Panic and Fire Exit Hardware.

Electrical Specifications

2 Amps @ 28 VDC
SPDT contacts

Ordering

Specify Quick Code M92.

Outside Monitoring or Signaling - M93

Provides indication of the device being operated from the outside. Used as a request to enter signal switch to shunt alarms; also used to monitor entry.

Application

See chart on page 36.

Listings

UL listed for both Panic and Fire Exit Hardware.

Electrical Specifications

2 Amps @ 28VDC
SPDT contacts

Ordering

Specify Quick Code M93.

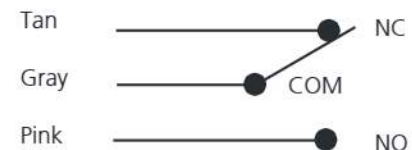
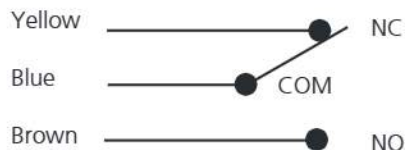
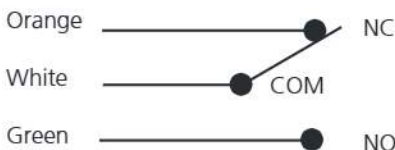

Cylinders

ED5000 Series

CR700 Series KRM* & Cylinder Dogging, Delayed Egress, and Alarm Mortise cylinders



Description	Part Number	Delayed Egress, Alarm, Cylinder Dogging Collars	Key Removable Mullions*	
			Part Number	Cylinder Collar
6-pin	CR1000-118-A02	N/A	CR1000-118-A02	None Required
7-pin	CR1000-114-A02-7	270F15	CR1000-114-A02-7	None Required
6-pin SFIC	CR1050-114-A02	270F15	None Required	None Required
7-pin SFIC	CR1050-112-A02-7	654F07	None Required	None Required
6-pin, SFIC, less core	CR1040-114-A02	270F15	None Required	None Required
7-pin, SFIC, less core	CR1040-112-A02-7	654F07	None Required	None Required
6-pin, LFIC	CR1080-114-A02	270F15	CR1080-114-A02	None Required
7-pin, LFIC	CR1080-112-A02-7	654F07	CR1080-112-A02-7	447F42
6-pin, LFIC, less core	CR1070-114-A02	270F15	CR1070-114-A02	None Required
7-pin, LFIC, less core	CR1070-112-A02-7	654F07	CR1070-112-A02-7	447F42
6-pin, Security	CR1010-118-A02	N/A	CR1010-118-A02	None Required
6-pin, Security IC	CR1090-114-A02	270F15	CR1090-114-A02	None Required
7-pin, Pyramid Security	CR1027-114-A02	270F15	CR1027-114-A02	None Required
7-pin, Pyramid Security IC	CR1037-114-A02	270F15	CR1037-114-A02	None Required
7-pin, Pyramid High Security	CR1020-114-A02	270F15	CR1020-114-A02	None Required
7-pin, Pyramid IC High Security	CR1030-114-A02	270F15	CR1030-114-A02	None Required

*The 700 series key removable mullion was discontinued on January 1, 2010. The cylinders and cylinder rings are listed for reference only.

CR900 Series Trim Rim cylinders

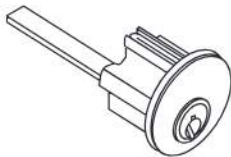

Description	Part Number	Cylinder Collar	57 Function Part Number	Cylinder Collar**
6-pin	CR3000-058	None Required	CR3000-200N*	None Required
7-pin	CR3000-058-7	686F98	CR3000-200-7	422F88
6-pin SFIC	CR3050-058	422F88	None Required	None Required
7-pin SFIC	CR3050-058-7	686F98	None Required	None Required
6-pin, SFIC, less core	CR3040-058	422F88	None Required	None Required
7-pin, SFIC, less core	CR3040-058-7	686F98	None Required	None Required
6-pin, LFIC	CR3080-058	422F88	CR3080-178	422F88
7-pin, LFIC	CR3080-058-7	686F98	CR3080-178-7	686F98
6-pin, LFIC, less core	CR3070-058	422F88	CR3070-178	422F88
7-pin, LFIC, less core	CR3070-058-7	686F98	CR3070-178-7	686F98
6-pin, Security	CR3010-058	None Required	CR3010-200	422F88
6-pin, Security IC	CR3090-058	422F88	CR3090-178	422F88
7-pin, Pyramid	CR3020-058	422F88	CR3020-200N	422F88
7-pin, Pyramid IC	CR3030-058	422F88	CR3030-178	422F88
7-pin, Pyramid Security	CR3027-058	422F88	CR3027-200N	422F88
7-pin, Pyramid Security	CR3037-058	422F88	CR3037-178	422F88

*For K157, substitute -200

**K157 uses the 270F15 cylinder ring

CR900 Series KRM Mortise cylinders



CR900 Series KRM
Mortise cylinders

Description	Part Number	Quick Code	900 Series Cylinder Collar			WS700 Series Cylinder Collar		
			1-1/8"	1-1/4" or 1-1/4" IC	1-1/2" IC	1-1/8"	1-1/4" or 1-1/4" IC	1-1/2" IC
6-Pin	CR1000-118-A62	6P						
7-Pin	CR1000-114-A62-7	7P						
6-Pin SFIC	CR1050-114-A62	C6S						
7-Pin SFIC	CR1050-112-A62-7	C7S						
6-pin, SFIC, less core	CR1040-114-A62	SFIC						
7-pin, SFIC, less core	CR1040-138-A62-7	SFIC						
6-Pin, LFIC	CR1080-114-A62	C6						
7-Pin, LFIC	CR1080-112-A62-7	C7						
6-pin, LFIC, less core	CR1070-114-A62	CL6	610F01*	447F43*	609F37*	447F42*	610F01*	609F36*
7-pin, LFIC, less core	CR1070-112-A62-7	CL7						
7-pin, Pyramid High Security	CR1020-114-A62	PHS						
7-pin, Pyramid Security	CR1027-114-A62	PS						
7-pin, Pyramid High Security IC	CR1030-114-A62	PCHS						
7-pin, Pyramid Security IC	CR1037-114-A62	PCS						
Security	CR1010-118-A62	HS						
Security IC	CR1090-114-A62	CHS						

*Specify Finish

Quick Codes

ED5000 Series

Cylinder and Keying

Description	Specify
Conventional 6-pin	6P
Conventional 7-pin	7P
LFIC	
LFIC 6-pin	C6
LFIC 6-pin less core	CL6
LFIC 6-pin with temporary construction core (Red)	CT6R
LFIC 6-pin with temporary construction core (Blue)	CT6B
LFIC 6-pin with temporary construction core (Green)	CT6G
LFIC 6-pin with temporary disposable core	CT6D
LFIC 7-pin	C7*
LFIC 7-pin less core	CL7*
LFIC 7-pin with temporary construction core (Red)	CT7R*
LFIC 7-pin with temporary construction core (Blue)	CT7B*
LFIC 7-pin with temporary construction core (Green)	CT7G*
LFIC 7-pin with temporary disposable core	CT7D*
SFIC	
SFIC 6-pin	C6S
SFIC 6-pin with temporary construction core (Blue)	CT6SB
SFIC 6-pin with Less Core	CLS6
SFIC 6-pin with SFIC disposable temporary core	CT6SD
SFIC 7-pin	C7S
SFIC 7-pin with temporary construction core (Blue)	CT7SB
SFIC 7-pin with Less Core	CLS7**
SFIC 7-pin with SFIC disposable temporary core	CT7SD*
Security	
Security	HS
Security IC	CHS
Access 3®	
Access 3® - Patented	AP
Access 3® - Security	AS
Access 3® - High Security	AHS
Access 3® IC - Patented	ACP
Access 3® IC - Security	ACS
Access 3® IC- High Security	ACHS
Pyramid	
Pyramid Security fixed core	PS
Pyramid Security IC	PCS
Pyramid High Security fixed core	PHS
Pyramid High Security IC	PCHS
Pyramid IC with temporary construction core	CTP
Pyramid IC with temporary disposable core	CTPD
Pyramid IC less core	CLP
Keying and Keys	
0-bitted with 2 blank keys	(standard)
Keyed random	KR
Construction master keyed	CMK
2 keys per lock	(standard)
More than 2 keys	KY# (e.g., KY6)
Visual key control (VKC)	
No keying data stamped on key or cylinder	VKC0
Keys only	VKC1
Cylinders and keys (not for HS, CHS, PHS or PCHS)	VKC2
Cylinders only (not for HS, CHS, PHS or PCHS)	VKC3
Concealed key control (CKC)	
CKC cylinders with VKC keys	CKC2
CKC cylinders only (not for HS, CHS, PHS or PCHS)	CKC3

*Not available with Rim or SVR lever trim - Classroom Function
+Not available with 55 function

Experience a safer
and more open world

ED5000.56

Strikes

Description	Specify
Rim x vertical rod on pairs of doors	S02
Surface and concealed vertical rod Bottom strike for 1/2" thresholds or flush mount	S09
Mortise ANSI strike for pairs of doors with astragal	SS078
Open back strike for 1-3/4" doors	SB134
Open back strike for 2-1/4" doors	SB214

Door Height

Door Height	Specify
ED5400(A) and ED5470(B) devices	
7'0"	(standard)
7'2"	H0702
7'6"	H0706
8'0"	H0800
ED5800(A) devices	
8'0"	(standard)
ED5470(B), ED5860(B) devices only	
9'0"	H0900
10'0"	H1000

Door Width

Door Width	Specify
24" (610mm)	W024
36" (914mm)	(standard)
48" (1219mm)	W048

Door Thickness

Door	Specify
1-3/4" (44mm)	(standard)
2" (51mm)	D200
2-1/4" (57mm)	D214

Quick Codes

ED5000 Series

Finish

	Description	Specify
US3	Bright Brass	605
US4	Satin Brass	606
US9	Bright Bronze	611
US10	Satin Bronze	612
US10B	Dark Oxidized Satin Bronze, oil rubbed	613
10BE	Dark Oxidized Satin Bronze Equivalent	613E
US14	Bright Nickel Plated	618
US15	Satin Nickel Plated	619
US26	Bright Chromium Plated	625
US26D	Satin Chromium Plated	626 ¹ (Trim only)
	Satin Chromium Plated with MicroShield®	626C ²
US32	Bright Stainless Steel	629
US32D	Stain Stainless Steel	630
	Stain Stainless Steel with MicroShield®	630C ²
—	Black oxidized bronze, oil rubbed	722
—	Black Suede Powder Coat	BSP
—	White Suede Powder Coat	WSP

1. Contact factory for devices required in BHMA 626
2. Finish available with MicroShield® antimicrobial coating.

Lock/Cylinder Finish

Lock	Cylinder/Core*
605,606,611,612,613,613E,722	606
618,619,625,626,626C,629,630,630C,WSP	626
BSP	BSP

*Finish when cylinder provided with lock

Miscellaneous Options

Description	Specify
Torx® head screws	M04
ANSI wrought strike box (mortise)	M17
Knurling outside and inside (embossed touchbar - device side) ¹	M20 ⁷
Knurling outside only (trim side) ¹	M21 ^{7,8}
Knurling inside only (embossed touchbar - device side)	M22 ⁷
Abrasive coat outside and inside (trim and device)	M23
Abrasive coat inside only (device side)	M24
Abrasive coat outside only (trim side)	M25
24", 36" and 48" PathLite™ Photoluminescent Touchbar Cover	M49
Less dogging	M51
Cylinder dogging	M52
Sex nuts and bolts (SNBs)	M54
Less bottom vertical rod (ED5470(B)/ED5860(B) Only)	M55
Narrow Stile Cover	M56
Shim kit (for vision light)	M58
Parabolic escutcheon	M60
Wood screws for use on fire-rated solid wood or wood core doors	M64
Flush transom top strike bracket (ED5400 and ED5400A only)	M67
Schlage cam and HSG assembly ⁶	M69
Windstorm Certified products for ED5200S(A) and ED5470(B) Only ^{2,3,4,5}	M107
High Impact End Clamp	M109
Flush End Cap	M110
5LB pressure release (ED5200 only)	5CH ⁹

Notes:

- Not available with VT9, VTL9, VT9M and VTL9M trim.
- ED5200S(A) x M107 requires through bolts.
- ED5470(B) maximum opening height is 8'0".
- Contact Ceco, Curries® or Fleming for detailed frame/door requirements and limitations.
- Not available with electric dogging (M97).
- M69 available for 955 and 959 trim only.
- All levers provided in a powder coat finish will be supplied with an abrasive coating.
- Not available on museo and vineyard levers
- 5CH is not compatible with the MELR option

Handing

Hand	Specify
Right Hand Reverse	RHR
Left Hand Reverse	LHR

Quick Codes

ED5000 Series

Key Removable Mullions

Description	Specify
Up to 7'2" Steel Mullion - 1-1/2 Hour Fire Rated	CR972BKM ¹
Up to 10'0" Steel Mullion - 1-1/2 Hour Fire Rated (Only fire rated up to 8')	CR910BKM ¹
Up to 7'2" Steel Mullion - 3 Hour Fire Rated, Windstorm Certified	CRWS772AKM ¹
Up to 8'0" Steel Mullion - 3 Hour Fire Rated, Windstorm Certified	CRWS708AKM ¹
Up to 8'0", Split Mullion Steel - Panic Rated	CR908KMSM

Note:

1. For use with UL listed door assemblies that comply to FEMA 361 and FEMA 320 guidelines. For the latest listings on compliant door assemblies visit our website at corbinrusswin.com

Removable Mullions

Description	Specify
Up to 7'2" Steel Mullion - Panic Rated	CR972
Up to 7'2" Steel Mullion - 3 Hour Fire Rated	CR972A
Up to 10'0" Steel Mullion - 3 Hour Fire Rated (Only fire rated up to 8')	CR910A
Up to 7'2" Steel Mullion - 3 Hour Fire Rated, Windstorm Certified	CRFE772A
Up to 8'0" Steel Mullion - 3 Hour Fire Rated, Windstorm Certified	CRFE708A ¹
Up to 8'0", Split Mullion Steel - Panic Rated	CR908SM

Note:

1. Cylinder and collars not included, specify separately. See page 54.

Electrified Options for Exit Devices

Description	Specify
Motorized Electric Latch Retraction	MELR
Exit Alarm Device (cylinder not included)	M61
Bolt Position Monitoring	M91
Request to Exit/Touchbar Monitoring or Signaling	M92
Outside Trim Monitoring or Signaling	M93
Electric Dogging	M97
Mortise Device Lock with Outside Trim Control (Fail Safe)	SAF*
Mortise Device Lock with Outside Trim Control (Fail Secure)	SEC*
Delayed Egress (15 second delay standard)	D
30 second delay (may be accepted by local jurisdiction) (with "D" option only)	M88
BOCA 15-second delay (with "D" option only)	M89
BOCA 30-second delay (with "D" option only)	M90
Security Monitor	M98 [^]
Trim Gasket	M99

*Only available with ED5600L and 5600(A)L
[^]9903/9905 trims only.

Electrified Accessories

Description	Part Number
Power Supply 3A@24VDC 6A@12VDC output	LSP12-24
SPDT Maintained Switch	MKA
SPDT Momentary Switch	MK
SPDT Momentary NS Switch	MKN
DPDT Momentary Switch	MK2
DPST Maintained (Al. Action) Switch	PB3EA
Sonalert 90lbs. @ 2 ft. 12-24VDC mounted on one gang stainless steel plate	PZ1
Alarm Kit (cylinder is not included)*	ED50AK
Concealed transfer for over 120° swing doors	EPTL

Interchangeable Core

Key Systems

Core Only



Description	Number	Remarks	EMK Blank
6-pin for CL3129	CR8001-031	Hotel indicator pin	-E8 Suffix
7-pin for CL3129	CR8001-031-7	Hotel indicator pin	-E8 Suffix
6-pin for CLX3329	CR8001-034A	Hotel	-E8 Suffix
7-pin for CLX3329	CR8001-034-7	Hotel	-E8 Suffix
6-pin standard	CR8000	Set to hotel mortise EMK	N/A
6-pin standard	CR8000EMK	-E1 suffix	
Security	CR8010EMK	Set to hotel mortise EMK	N/A
Security	CR8010		-E1 suffix
7-pin	CR8000-7	Hotel indicator pin	N/A
6-pin for CL3329, CL3629	CR8001-034	Hotel indicator pin	-E8 suffix
7-pin for CL3329, CL3629	CR8001-034-7	Hotel indicator pin	-E8 suffix
6-pin for CLX3329	CR8001-034A	Hotel indicator pin	-E8 suffix
7-pin for CLX3329	CR8001-034A-7	Hotel indicator pin	-E8 suffix
6-pin for CK4229	CR8001-042	Hotel indicator pin	-E4 suffix
Security for CK4229	CR8011-042		-E4 suffix
Pyramid High Security	CR8020		N/A
Pyramid Security	CR8027		N/A
SFIC	CR8200	6-pin	N/A
SFIC	CR8200-7	7-pin	N/A

Specify Keyway

Finishes: 606, 626, & BSP only. Plugs and shells for SFIC cylinders are provided in 606 or 626 only. Uncombined cores: Specify "UC". Keys not provided. Not applicable for 8000EMK, 8010EMK

1006 Series Electric Strike

*Works with all cylindrical
and mortise locksets with
or without a deadbolt*

Also available in
Complete One Box
Solution



The strongest, most versatile electric strike available.

The HES 1006 series is the strongest and most versatile electric strike available. The dual interlocking plunger design and heavy duty stainless steel construction, enables it to exceed every standard developed for electric strikes. With multiple faceplate options, the 1006 will fully accommodate every lock designed to work within an ANSI 4-7/8" strike plate. Tested to exceed 3,000 lbs. of static strength, 350 ft-lbs. of dynamic strength and factory tested to exceed 1,000,000 cycles of operation, the 1006 is in a class of its own.

Features

- Stainless steel construction
- Tamper resistant
- Static strength 2,500 lbs. (fail secure)
- Dynamic strength 350 ft-lbs. (fail secure)
- Endurance 1,000,000 cycles
- Fail secure (standard)
- Non-handed
- Accommodates up to 1" [25.4mm] deadbolt
- Plug-in connector
- Full keeper shims for horizontal adjustment
- Trim enhancer
- Strike body depth 1-11/16" [43mm]
- SecuriCare five-year, no-fault, no questions asked warranty (Addition of SMART Pac® III extends the warranty to 10 years)

Options

- LBM - Latchbolt monitor
- LBSM - Latchbolt strike monitor
- Fail Safe
- Interchangeable faceplates
- Monitor switch may not work with all faceplate options

Accessories

- 157 Torx® screws
- 1000-102 Rain guard
- 1006-103 Full Keeper Shims
- 1000-104 Lip Extension Trim Adapter
- 1006-105 Trim Enhancer
- 1000-110 Replacement Strike Plate
- 1000-130 KD Filler Plate
- 150 Strike Latch Guard
- HES-CUT-MTK Metal Template Kit
- 2005M3 SMART Pac® III



Grade 1



SecuriCare
Warranty



Mortise Locks
with Deadbolt



Mortise Locks
without
Deadbolt



Cylindrical
Locksets



Specialty
Locksets



Dual Voltage
12/24



Fire Rated



Windstorm
Resistant



Outdoor
Rated



Burglary
Rated

h.e.s.

ASSA ABLOY

1006 Series Electric Strike

Certifications

- ASTM E152 Fire Door Compliant
- ASTM E330 Certified
- ANSI/BHMA A156.31, Grade 1
- ANSI/SDI 250.13 Certified
- Florida Building Code Approved FL# 16392
- NFPA-252 Fire Door Compliant
- RoHS Compliant
- UL 10C Fire Rated
- UL 294 Listed
- UL 1034 Burglary-Resistant Listed and Suitable for Outdoor Use

Specifications

Frame Application

- Metal
- Wood

Electrical

- Dual Voltage 12/24 VDC
- 480 mA at 12 VDC
- 240 mA at 24 VDC

NOTE: DC must be well filtered with ripple less than 1 volt 12 ms.

Dimensions

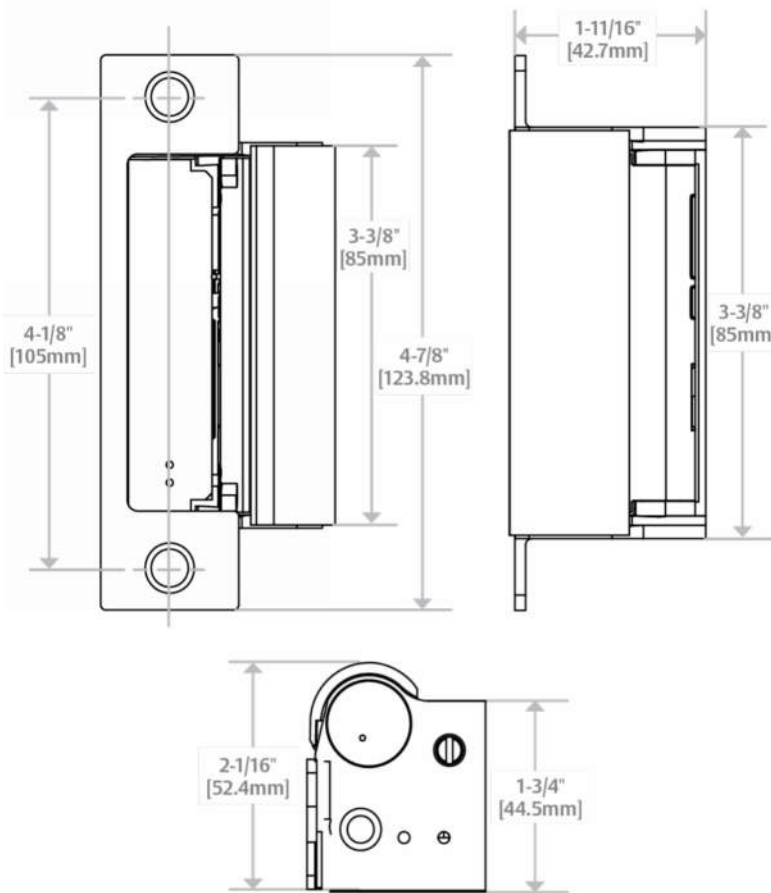

Diagram shown with DB faceplate

How to Order

SERIES	MODEL	FAIL SECURE / SAFE	FINISH*	OPTION (S)
1006	—	— F	— 630	— LBM
1006 Universal Electric Strike	<p>(blank) Electric strike body only, faceplates ordered separately</p> <p>CS* Complete Electric Strike; includes the SMART Pac III and J, KD, KM, HM, ND faceplates and brackets</p> <p>CLB* Complete Electric Strike for latchbolt locks; includes J, K, KD and KM faceplates</p> <p>CDB* Complete Electric Strike for Deadbolt Locks; includes the ND and HM faceplates</p> <p>CAS* Complete Electric Strike for Deadbolt Locks; includes the N, ND and NM faceplates</p>	<p>(blank) Fail Secure (standard)</p> <p>F Fail Safe</p>	<p>605 Bright Brass</p> <p>606 Satin Brass</p> <p>612 Satin Bronze</p> <p>613E Dark Oxidized Satin Bronze Powder</p> <p>629 Bright Stainless Steel</p> <p>630 Satin Stainless Steel</p> <p>BLK Black</p>	<p>(blank) No Monitor</p> <p>LBM Latchbolt Monitor**</p> <p>LBSM Latchbolt Strike Monitor**</p>

*Complete Pacs are only available in the 630 finish. ** Not available with CS, CDB, or CAS

NOTE: Electric strike compatibility is determined at time of electric strike product release. ASSA ABLOY is not responsible for incompatibility of products that have changed in design or craftsmanship by their respective manufacturers. When compatibility is a concern, contact Customer Support for application assistance.

1006CS Smart Strike™

The Complete One Box Solution for all cylindrical and mortise locksets, with or without a 1" deadbolt

The 1006CS Smart Strike includes a 1006 electric strike body and SMART Pac® III plus faceplates and brackets that can provide the same function as any of the following options:

J Option	H Option	HTD Option
K Option	HD Option	N Option
KD Option	HM Option	ND Option
KM Option	HT Option	NM Option

Compatible Locksets

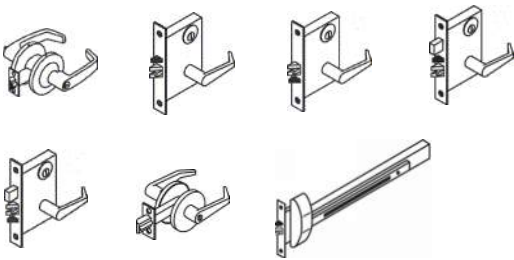

1006CLB Complete for Latchbolt Locks

The Complete One Box Solution for all cylindrical and mortise locksets

The 1006CLB includes the 1006 electric strike body plus faceplates and brackets that provide the same function as any of the following options:

J Option	KD Option
K Option	KM Option

Compatible Locksets

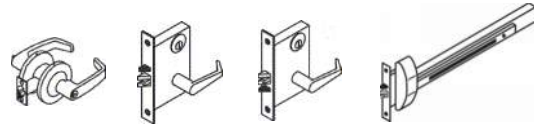

1006CAS Complete for Recapture

The Complete One Box Solution for deadbolt recapture

The 1006CAS Smart Strike includes a 1006 electric strike body plus faceplates and brackets that can provide the same function as any of the following options:

A Option	N Option	T Option
AD Option	ND Option	TD Option
AM Option	NM Option	

Compatible Locksets



1006CDB Complete for Deadbolt Locks

The Complete One Box Solution for all locksets with a 1" deadbolt

The 1006CDB includes the 1006 electric strike body plus faceplates and brackets that provide the same function as any of the following options:

H Option	HT Option	ND Option
HD Option	HTD Option	NM Option
HM Option	N Option	

Compatible Locksets



1006 Series Faceplate Options

OPERATION



Mortise Locks
with Deadbolt

Latchbolt and deadbolt are released by a single keeper. The keeper is held open to recapture the latchbolt and deadbolt when the door is closed.

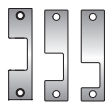

4-7/8" × 1-1/4"
[123.8mm x
31.75mm]

LB Option

The Latchbolt Solution: Includes all hardware to accommodate every cylindrical and mortise lock up to a 3/4" [19mm] latchbolt

Replaces function of the J, K, KM and KD Options.

ANSI/BHMA Numbers: E09321, E09322, E09323

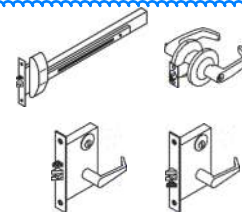

OPERATION



Mortise Locks
with Deadbolt

This deadbolt solution offers two modes of functionality; night latch and lockout. (Functional operation modes described below.)

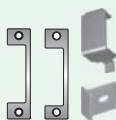

4-7/8" × 1-1/4"
[123.8mm x
31.75mm]

DB Option

The Deadbolt Solution: Includes all hardware to retain and release all mortise and cylindrical locks with up to a 1" deadbolt

Mode 1: Night latch function. The deadbolt is retracted during traffic hours. The latchbolt is released by the keeper and keeper returns to the locked position.

Mode 2: Lockout function. The electric strike will not release if the deadbolt is extended.

Replaces function of the N, ND, NM, H, HD, HM, HT, and HTD options

ANSI/BHMA Numbers: E09391, E09392, E09393, E09331, E09332, E09333

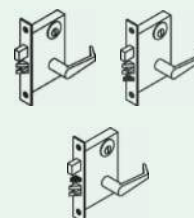

OPERATION



Mortise Locks
with Deadbolt

This deadbolt solution offers two modes of functionality; night latch and lockout. (functional operation modes described below.)

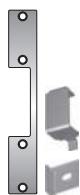

9" × 1-3/8"
[123.8mm x
34.9mm]

DB-2 Option

The Deadbolt Solution: Includes all hardware to retain and release all mortise and cylindrical locks with up to a 1" deadbolt. Wood applications.

Mode 1: Night latch function. The deadbolt is retracted during traffic hours. The latchbolt is released by the keeper and keeper returns to the locked position.

Mode 2: Lockout function. The electric strike will not release if the deadbolt is extended.

Replaces the N-2 and H-2 options

ANSI/BHMA Numbers: E09391, E09392, E09393, E09331, E09332, E09333

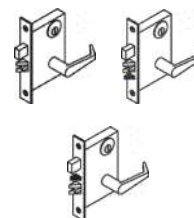

OPERATION



Mortise Locks
with Deadbolt

Latchbolt and deadbolt are released by a single keeper. The keeper is held open to recapture the latchbolt and deadbolt when the door is closed.

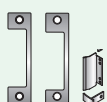

4-7/8" × 1-1/4"
[123.8mm x
31.75mm]

CAS Option

The Continuous Deadbolt Recapture Solution: Includes all hardware to retain, release and recapture all mortise locks and tubular E Option locks with up to a 1" deadbolt.

Mode: Normally extended deadbolt. Latchbolt and deadbolt are released by a single keeper. The keeper is held open to recapture the latchbolt and deadbolt when the door is closed.

Replaces the N, ND, NM, A, AM, AD, T and TD options

ANSI/BHMA Numbers: E09391, E09392, E09393, E09331, E09332, E09333

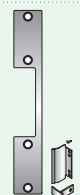
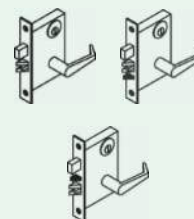

9" × 1-3/8"
[123.8mm x
34.9mm]

CAS-2 Option

The Deadbolt Solution: Includes all hardware to retain, release and recapture all mortise locks and tubular locks with up to a 1" deadbolt. Wood applications.

Mode: Normally extended deadbolt. Latchbolt and deadbolt are released by a single keeper. The keeper is held open to recapture the latchbolt and deadbolt when the door is closed.

Replaces the N-2, A-2 and T-2 options

ANSI/BHMA Numbers: E09391, E09392, E09393, E09331, E09332, E09333

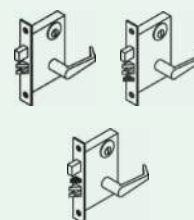

Experience a safer
and more open world

Rockwood 70F - Push Plate - .050" Thick



Specifications:

MATERIAL:

Aluminum, Brass, Bronze, or Stainless Steel

FASTENER:

#6 x 5/8" Oval Head Sheet Metal Screws

FEATURES:

Four beveled edges

ORDERING:

Specify plate number followed by size designation and finish (70F US32D) or for non-standard size 70
Specify width x height and finish. Specify any additional options.

OPTIONS:

- Custom sizes available upon request
- TEK - self-drilling screws
- TORX - security Torx screws
- SA - self-adhesive mounting: 1/16" double face foam tape (no screw holes on plate)
- Engraving on plates 4" wide or wider. Specify copy.
- Cylinder cutouts (CFC) and turn knob cutouts (CFTT)
- Heavy bevel available on 70A to 70G, specify HVBEV

Available Finishes:

- US28/628
- US3/605
- US4/606
- US10/612
- US10B/613
- US10BE/613E
- US26/625
- US26D/626
- US32D/630
- US32/629
- US32DMS
- US32D316
- US32316

STANDARD SIZE:
8" x 16"

WEIGHT:
2.0 lbs.

ANSI A156.6: J301

Rockwood 107 x 70C

4" x 16" Pull Plate

Experience a safer
and more open world



SPECIFICATIONS:

MATERIAL:

Aluminum, Brass, Bronze,
or Stainless Steel

FASTENERS:

#6 x 5/8" Oval Head Sheet
Metal Screws; 1/4"-20 x 2 1/4"
Thru Bolt & Finish Washer
(standard 1 3/4" door)

OPTIONS:

- Barrier Free available in 2 1/2" clearance – use BF prefix when ordering (BF107 x 70C)
- Advise if door thickness is other than 1 3/4"
- Mounting selections for standard duty 1/4"-20 can be viewed under Mounting Details at www.rockwoodmfg.com

AVAILABLE FINISHES:

- US3/605
- US4/606
- US10/612
- US10B/613
- 10BE/613E
- US26/625
- US26D/626
- US28/628
- US32/629
- US32316
- US32MS
- **US32D/630**
- US32DMS
- US32D316
- BSP (Black Suede Powder Coat)
- BPC (Black Powder Coat)
- FBPC (Flat Black Powder Coat)

Pull: Ø 3/4"

Size: 4" x 16"

CTC: 8"

Plate: 70

Weight: 2.5 lbs.

Rockwood Manufacturing Company
300 Main St.
Rockwood, PA 15557
www.rockwoodmfg.com
1 800 458 2424

Copyright © 2019-2025, ASSA ABLOY Accessories and Door Controls Group, Inc. All rights reserved. Reproduction in whole or in part without the express written permission of ASSA ABLOY Accessories and Door Controls Group, Inc. is prohibited. Printed in the U.S.A.



DC6000 Series Door Closers

Product Catalog

Experience a safer
and more open world

Features

DC6000

DC6200 - Multi-Sized
DC6400 - Sizes 1-6, half size adjustable

Features

Spring Power

DC6200 closers: multi-sized; fully adjustable sizes 1 through 6.
DC6400 closers: sizes 1 through 6; half-size adjustability.
For recommended sizes, see page 14.

Handing

Non-handed (with the exception of some arms and accessories).

Body

Cast-iron case with seamless cold headed steel spring tube.

Arm

Standard: forged steel.
Arm options pages 8-10.

Spindle

Heat-treated steel with a crowned gear set for increased efficiency.

Piston

1-3/8" diameter; precision machined, heat-treated steel.

Springs

Chrome silicon wire.

Valves

Latching speed valve standard.

Closing speed valve standard.

Multiple backcheck location valve and backcheck intensity valve standard.

Delayed action valve optional. Delayed action preset for 20 seconds. Between 90° and 70° for all mountings. To order specify M71.

Seals

"O" rings.

Fluid

Standard: high lubricity extreme temperature hydraulic fluid.

Degree of Opening

Up to full 180° opening standard for regular, top jamb and parallel arm mountings, conditions permitting.

Power Adjustment Arm Bracket

15% adjustment standard.

Cover

Standard: plastic V-O flame rated cover.
Optional: full metal cover; specify M73 x hand.

Mountings

Standard: regular or top jamb.
Parallel arm or tri-style packaging: specify DC6210 or DC6410.
Optional mountings available; see Mountings, page 6.

Mounting Bracket

Quik-Install™ mounting bracket standard.

Fasteners

Standard: self-drilling screws.
Optional: sex nuts and bolts (SNBs); specify M54.

Corrosion Protection

Painted protective coating on all metal surfaces for use in corrosive environments.

Security Package

Includes heavy-duty parallel or regular arm, full metal cover and security Torx® machine screws. Specify M87 x arm x hand. See pages 8-12 for arm options.

Warranty

30-year limited warranty. Refer to Corbin Russwin price book for details.

Certification/Compliance



Barrier-Free Code Compliance

The DC6000 Series Door Closers listed below conform to the 5 lbf. maximum door opening force requirement for non-fire-rated interior hinged doors, according to:

Americans with Disabilities Act (ADA)
Complies with the Accessibility Guidelines for Buildings and Facilities, Section 4.13.11

ANSI/BHMA

A156.4, Grade 1.
A117.1.

DC6200	DC6412
DC6210	DC6421
DC6220	DC6401
DC6411	

These door closers are certified by Corbin Russwin Architectural Hardware to comply with the above standards when properly installed and (if applicable) adjusted, in regular arm, parallel arm and top jamb mountings.

UL10C positive pressure up to 3 hours UL-cUL

Listed for fire and cycle requirements.

Cycles

Exceeds 25 million cycles

CAUTION: Door Closers for Low Opening Force Applications:

Door closers installed in openings required to meet the requirements of the Americans With Disabilities Act or ANSI/BHMA Standard A117.1, when adjusted to meet those requirements, may not provide adequate closing power to dependably close and latch the door based on opening or site conditions.

Finishes

Specify	Description
600 (USP)	Primed
BHMA 605 (US3)*	Bright Brass
BHMA 606 (US4)*	Satin Brass
BHMA 611 (US9)*	Bright Bronze
BHMA 612 (US10)*	Satin Bronze
613E	Dark Oxidized Satin Bronze, Equivalent
BHMA 625 (US26)*	Bright Chromium Plated
BHMA 626 (US26D)*	Satin Chromium Plated
689 (SBL)	Silver Aluminum
690 (DBL)	Dark Bronze
691 (LBL)	Light Bronze
693 (FBL)	Black
696 (GBL)	Satin Brass
BSP	Black Suede Powder Coat
WSP	White Suede Powder Coat

*Metal cover is required for these finishes.

For split finish on closer cover and arm, specify cover finish first, then arm finish. (e.g., DC6200 x 625 x 689).

DC6200 - Multi-Sized DC6400 - Sizes 1-6, half-size adjustable

Spring Power Adjuster
(with double o-ring seal)

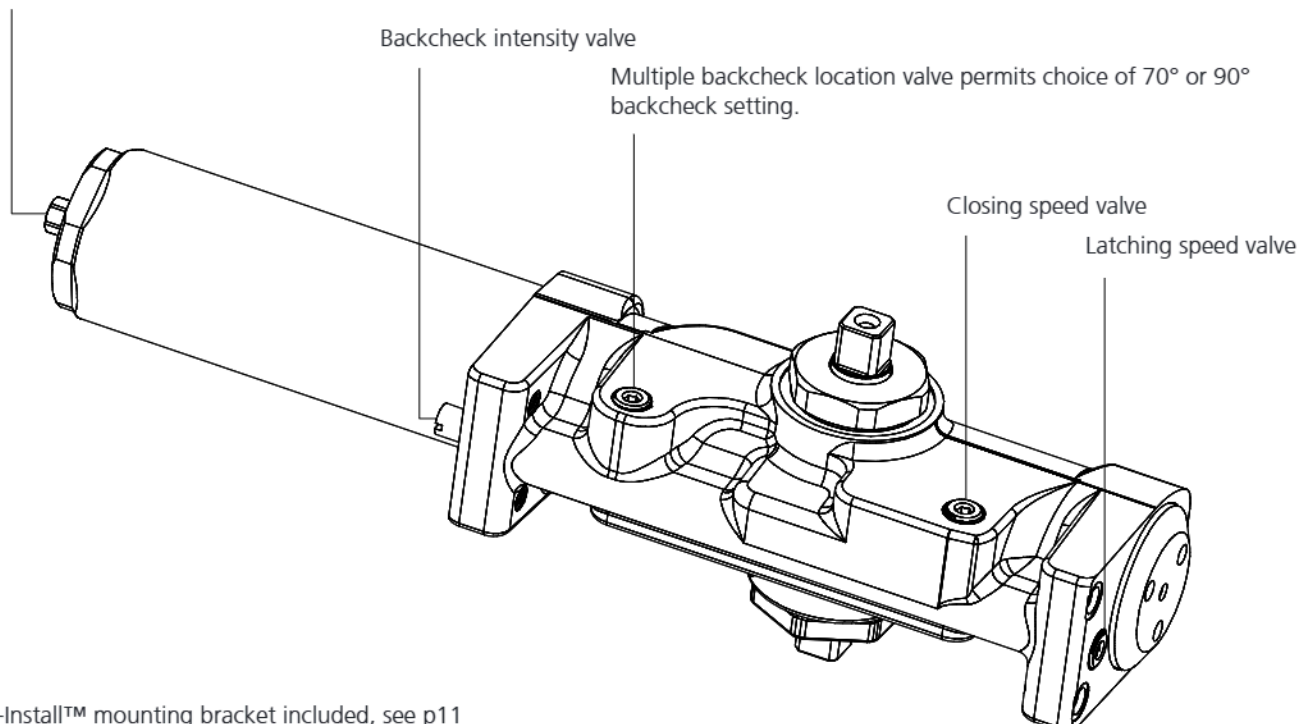

Quik-Install™ mounting bracket included, see p11

Mountings and Applications

DC6000 Series



Regular Arm Mounting DC6200, DC6400 Series

Most common mounting, providing the greatest closing efficiency. Closer is mounted on the pull side, with the arm almost perpendicular to the face of the door. Arm bracket is attached to the door frame.



Parallel Arm Mounting DC6210, DC6410 Series

Allows inside application of closer on out-swinging doors. Closer is mounted on the push side, with the arm almost parallel to the face of the door. Arm does not project from the opening.



Top Jamb Mounting DC6220, DC6420 Series

Closer is mounted on the frame on the push side, with the arm perpendicular to the face of the door. Arm bracket is mounted on the door. Minimum 1-3/4" (44mm) top jamb required. Accommodates reveals up to 3-1/4" (83mm).



Track Mounting DC6230, DC6430 Series

Closer is top jamb mounted on the pull side; arm is connected to a door-mounted track. Maximum degree of opening is 110°. Maximum closing power is size 4. Minimum 3" (76mm) frame face required.



Track Mounting DC6240, DC6440 Series

Closer is mounted on push side of door; arm is connected to a stop-mounted track. Maximum degree of opening is 110°. Maximum closing power - size 4.

Door weight: 250 lbs.

Arm Options

DC6000

688F95
(Non-Hold Open)

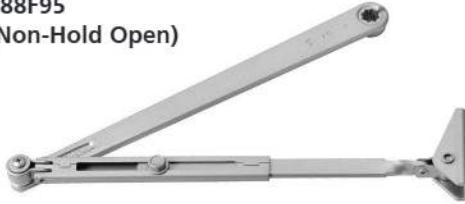

688F77
(Hold Open)



691F72
(Non-Hold Open)



Regular Arm

- Used with regular arm (pull side) and top jamb (push side) mounting
- Available in painted or plated finishes
- Non-hold open arm standard on the DC6200 and DC6400 closers
- Hold open arm optional, specify closer x **A1***

Deep Reveal Arm (3-3/8" (86mm) - 7-1/4" (184mm))

- Accommodates top jamb mounting for reveals up to 7-1/4" (184mm), depending on door and frame conditions
- Mounted on push side
- Available in painted or plated finishes
- Optional on DC6220 and DC6420 closers
- Non-hold open, specify closer x **A6**
- Hold open, specify closer x **A8***

Non-Hold Open	691F72
Hold Open	691F74

597F52
(Non-Hold Open Only)



Heavy-Duty Regular Arm

- Recommended for high-use, high-abuse environments
- Tamper-resistant, solid forged steel riveted arm
- Mounted on pull side
- Not available in plated finishes
- Optional on DC6200 and DC6400 closers, specify closer x **A10**

688F95 x 188F41
(Non-Hold Open)



Parallel Arm

- Mounted on push side
- Non-hold open arm – combines regular arm with parallel arm mounting bracket
- Available in painted or plated finishes
- Hold open arm – combines regular hold-open arm with parallel arm mounting bracket
- Non-hold open arm standard – order DC6210 or DC6410 series
- Hold open arm optional, specify closer x **A1***

688F77 x 509F49
(Hold Open)



Specify finish when ordering arms. *Not allowed by code on fire doors.

689F02
(Non-Hold Open)



689F01
(Hold Open)



689F03
(Non-Hold Open)



689F04
(Hold Open)



(Non-Hold Open)

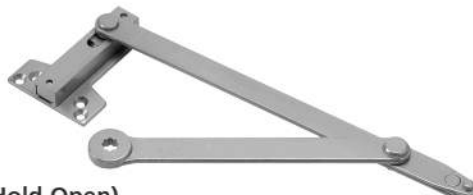

(Hold Open)



Refer to page 12 for bracket information

Specify finish when ordering arms.
*Not allowed by code on fire doors.

Heavy-Duty Parallel Arm

- Recommended for high-use, high-abuse environments
- Tamper-resistant, solid forged steel riveted arm
- Mounted on push side
- Not available in plated finishes
- Optional on DC6210 and DC6410 closers
- Non-hold open arm, specify closer x **A3**
- Hold open arm, specify closer x **A2***. Hold-open range 85° to 110°
- For use with overhead stops, specify closer x **A13** (see page 10)

Heavy-Duty Reversible Backstop Parallel Arm

- Recommended for high-use, high-abuse environments
- Tamper-resistant, solid forged steel riveted arm
- Mounted on push side
- Not available in plated finishes
- Optional on DC6210 and DC6410 closers
- Field-reversible steel lug restricts degree of opening to protect door, wall and hardware
- Shipped standard as left hand. Handing can be reversed in the field
- Non-hold open arm, specify closer x **A4**. Door stop range 85° to 110°
- Hold open arm, specify closer x **A5***. Door stop/hold open range 85° to 110°

Heavy-Duty Spring Stop Parallel Arm

- Recommended for high-use, high-abuse environments
- Integrates a door closer, shock absorber and auxiliary heavy-duty overhead stop
- Not available in plated finishes
- Hold open*
 - Holder mechanism tension adjustable
 - Hold open can be engaged/disengaged with a 1/4 turn of the mechanism with a standard blade type screwdriver
- Optional on DC6210 and DC6410 closers
- Non-hold open arm, specify closer x **A11 x door width**. Door stop range 85° to 110°.
- Hold open arm, specify closer x **A12* x door width**. Door stop/hold open range 85° to 110°.

Door Width	Model Number	
	Non-Hold Open	Hold Open
28" - 32" (71cm - 81cm)	615F52	615F51
33" - 41" (84cm - 104cm)	615F54	615F53
42" - 48" (107cm - 122cm)	615F56	615F55

597F78



Full Cover

- Standard on all DC6000 series door closers
- Completely covers closer body
- Non-handed
- Dimensions: 11-5/8" (295mm) x 3" (76mm) x 2-3/4" (70mm) deep
- Available in painted finishes only
- Flame rated V-O material compliant with UL10C



Full Metal Cover

- For use in high-abuse applications or when an architectural plated finish is desired
- Specify hand; not field reversible
- Available in painted and plated finishes
- Dimensions: 11-1/2" (292mm) x 2-7/8" (73mm) x 2-3/4" (70mm) deep

Part Number	Handing
603F55	RH/LHR
603F57	LH/RHR



Drop Plate

Permits parallel arm mounting on door when top rail is too narrow to install closer in the regular manner. Minimum 2-5/8" (67mm) top rail required. Jamb mounted where there is insufficient ceiling clearance for standard mounting or where it is necessary to allow vertical arm clearance for overhead door holders or frame gasketing. To order separately, specify Part No. x Finish.

Closer Series	Drop Plate
	With Full Cover
DC6210, DC6410	597F58
DC6220, DC6420	188F65
DC6240, DC6440	597F59

Handing

Refers to the direction a door swings; always determined from the outside of the door.

Regular Mounting

Door: left hand
Closer: left hand pull side

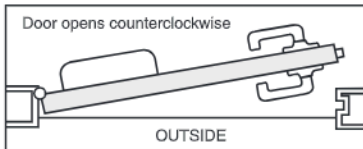

Door: right hand
Closer: right hand pull side

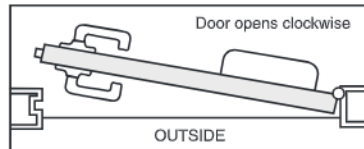

Parallel Arm Mounting

Door: left hand reverse bevel
Closer: right hand push side

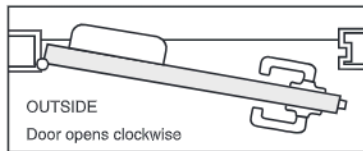

Door: right hand reverse bevel
Closer: left hand push side

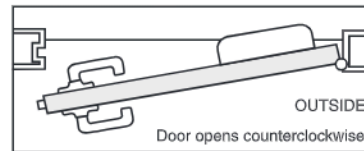

Top Jamb Mounting

Door: left hand reverse bevel
Closer: right hand push side

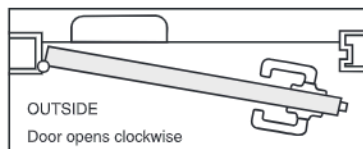

Door: right hand reverse bevel
Closer: left hand push side

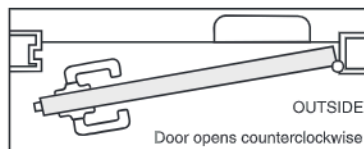

Helpful Terms

DC6000

Backcheck

Slows a door at approximately 70° of the opening cycle, by providing cushioned resistance to a forceful opening. Designed to protect people and objects behind the door and to prevent damage to the closer, hardware, and wall. Intensity can be increased or decreased. Not intended to act as a stop.

Backcheck Location

The point (approximately 70°) in the opening cycle where backcheck takes effect.

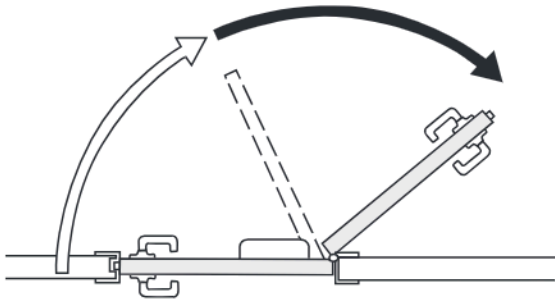

Closing Speed

The speed at which a door swings from the full open position to within a few degrees of latching. See Latching Speed.

Corrosion Protection

Additional painted covering on all external parts to deter oxidation and corrosion.

Delayed Action

Slows door closing speed between maximum opening and approximately 70°. Often specified to meet barrier-free codes which require longer closing times. Also used in high traffic situations (auditoriums, classrooms, etc.) or when carts and gurneys are pushed through the doors.

Door Stop

A device to stop the swing of a door.

Hold Open

Maintains door at a particular degree of opening. A mechanical hold open may not be used on labeled fire doors, which must be self-closing.

Multi-Sized Closer

A closer whose spring design allows full adjustment of the spring power size from 1 through 6.

Latching Speed

The speed of the door during the last few degrees of closing. Allows latching and prevents slamming.

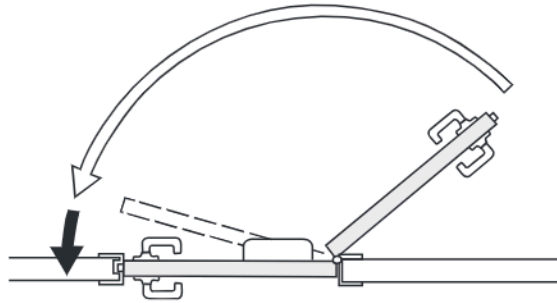

Mounting

The method by which a closer is attached to the door and frame.

Multiple Backcheck Location Valve

Valve that changes the degree of door angle where backcheck occurs.

Quik-Install™ Mounting Bracket

Unique bracket which simplifies installation and minimizes installer fatigue.

Sex Nuts and Bolts (SNBs)

Through-bolts required for all non-steel-reinforced fire doors, and recommended for non-reinforced wood and mineral core doors.

Sized Closer

A closer whose spring design allows for a fixed spring power size 1 through 6.

Spring Power

A measurement of closing force, or the ability to overcome draft, air pressure, weight or other resistance to door closing.

Star Punch

An eight-point hole in the closer arm, permitting spindle pre-loading. Provides full functioning of backcheck and delayed action valves.

Universal Mounting

The ability of a closer to accommodate either hand for regular, top jamb or (using a bracket) parallel arm mounting.

Quick Codes

DC6000

Arm

Arm	Specify Quick Code
Regular non-hold open	(standard)
Hold open	A1*
Heavy-duty parallel with hold open	A2*
Heavy-duty parallel non-hold open	A3
Heavy-duty backstop non-hold open	A4
Heavy-duty backstop with hold open	A5*
Deep reveal (3-3/8" -7-1/4")	A6
Deep reveal with hold open	A8*
Heavy-duty regular non-hold open	A10
Spring stop non-hold open (specify door width)	A11
Spring stop heavy-duty with hold open (specify door width)	A12*
Heavy-duty parallel arm with extra clearance	A13
Heavy-duty friction hold open arm (specify hand)	A14*
Push side track with hold open	A1*

*Hold open arms cannot be used on fire doors.

Handing

Hand	Specify
Left Hand/Right Hand Reverse	LH
Right Hand/Left Hand Reverse	RH

Blade Stop

Spacer	Specify Quick Code
1/2"	M77
5/8"	M78

Torx® Tool Kit Package

Description	Specify
Bits and driver	597F24

Finish

Old Designation	Description	Specify Quick Code
USP	Primed	600
US3	Bright Brass	605*
US4	Satin Brass	606*
US9	Bright Bronze	611*
US10	Satin Bronze	612*
N/A	Dark Oxidized Satin Bronze, Equivalent	613E
US26	Bright Chromium Plated	625*
US26D	Satin Chromium Plated	626*
SBL	Silver Aluminum	689
DBL	Dark Bronze	690
LBL	Light Bronze	691
FBL	Black	693
GBL	Satin Brass	696
BSP	Black Suede Powder Coat	BSP
WSP	White Suede Powder Coat	WSP

*Metal cover is required for these finishes.

For split finish on closer cover and arm, specify cover finish first, then arm finish. (e.g., DC6200 x 625 x 689).

Door Thickness

Door Thickness	Specify
1-3/4" (44mm)	(standard)
2" (51mm)	D200
2-1/4" (57mm)	D214

Miscellaneous Options

Description	Specify Quick Code	
Torx® machine screws	M04	
Sex nuts and bolts (SNBs) (1-3/4" minimum thickness)	M54	
Backcheck intensity and location valves	(standard)	
Delayed action	M71	
Full cover	(standard)	
Full metal cover (Handed)	M73	
Extreme temperature fluid	(standard)	
Corrosion protection	M75	
1/2" spacer	M77	
5/8" spacer	M78	
Drop plates - order by number (formerly M80, M81 and M102 quick codes)		
Closer Series	Old Quick Ship #	Drop Plate With Full Cover
DC6210, DC6410 (Parallel)	M80	597F58
DC6220, DC6420 (Top Jamb)	M80	188F65
DC6230, DC6430 (Pull Side)	M81	597F59
DC6240, DC6440 (Push Side)	M102	597F59
Heavy-duty parallel arm flush transom bracket (499F30) used with A2, A3, A4, A5, A13 & A14 arms		M79
Parallel arm flush transom bracket (parallel or A1)		M82
Parallel arm offset bracket		M83
Mortise arm bracket (for regular arm mounting)		M84
Angle support bracket		M85
Spacer (691F78) (formerly M86 quick code)		(standard)
Security package (available with A2, A3, A4, A5 and A10 optional arms). Covers are handed.		M87
Deep reveal reinforcement kit (available with A11 & A12 arms)		M103
Flush partition bracket (available with A11 & A12 arms)		M104
Lead-lined metal cover		M108

Rockwood K1050

Metal Kick Plate

.050" Thick



SPECIFICATIONS:

MATERIAL:

.050" Aluminum, Brass,
Bronze, Stainless Steel

FASTENERS:

#6 x 5/8" Oval Head Sheet
Metal Screws

FEATURES:

- Push Side Plate Width - 2" less than door width.
- Pull Side Plate Width - 1 1/2" less than door width.
- All Edges come Beveled.

ORDERING:

Specify height x width x finish code. Add any options.

OPTIONS:

- SA - self-adhesive mounting
- TEK - self-drilling screws
- Heavy bevel available, specify HVBEV
- CSK - countersunk holes
- Cutouts for locks, louvers, or windows
- TORX - security torx screws

NFPA 80 STANDARDS - 2-4.5 Protection Plates: Factory-installed protection plates shall be installed in accordance with the listing of the door. Field-installed protection plates shall be labeled and installed in accordance with their listing.

Exception: Labeling is not required where the top of the protection plate is not more than 16 in. (406 mm) above the bottom of the door.

NOTE: Finishes US26/625 and US26D/626 are only available up to 24"H.

AVAILABLE FINISHES:

- US3/605
- US4/606
- US9/611
- US10/612
- US10B/613
- 10BE/613E
- US26/625
- US26D/626
- US28/628
- US32/629
- US32D/630
- US32D316
- US32DMS
- BSP (Black Suede Powder Coat)
- BPC (Black Powder Coat)
- WSP (White Suede Powder Coat)
- WPC (White Powder Coat)
- FBPC (Flat Black Powder Coat)
- RPC (Red Powder Coat)

Weight: 8" x 34" = 4.0 lbs.

Rockwood Manufacturing Company
300 Main St.
Rockwood, PA 15557
www.rockwoodmfg.com
1 800 458 2424

Copyright © 2019-2025, ASSA ABLOY Accessories and Door Controls Group, Inc. All rights reserved. Reproduction in whole or in part without the express written permission of ASSA ABLOY Accessories and Door Controls Group, Inc. is prohibited. Printed in the U.S.A.

Rockwood 406

Convex Wrought Wall Stop

Experience a safer
and more open world



SPECIFICATIONS:

MATERIAL:

Wrought Brass, Bronze,
and Stainless Steel with
Rubber Bumper

FASTENERS:

#8 x 1¹/₄" Truss Head Sheet
Metal Screw, Plastic Toggle

FEATURES:

Concealed mounting,
convex bumper. Back plate
prevents damage to wall.

BUMPER:

Convex

AVAILABLE FINISHES:

- US3/605
- US4/606
- US10/612
- US10BE/613E
- US26/625
- **US26D/626**
- US32D/630
- BSP (Black Suede
Powder Coat)

Size:

Ø 2 1/2"

Projection: 1"

Weight:

1.25 lbs./10

Rockwood Manufacturing Company
300 Main St.
Rockwood, PA 15557
www.rockwoodmfg.com
1 800 458 2424

Copyright © 2019-2024, ASSA ABLOY Accessories and Door Controls Group, Inc. All rights reserved. Reproduction in whole or in part without the express written permission of ASSA ABLOY Accessories and Door Controls Group, Inc. is prohibited. Printed in the U.S.A.

Rockwood 441

Low Dome Stop

Experience a safer
and more open world



SPECIFICATIONS:

MATERIAL:

Solid Cast Brass with
Rubber Bumper

FASTENERS:

#12 x 1 1/4" Flat Head Wood
Screw, Plastic Anchor

#12-24 x 1 1/2" Flat Head
Machine Screw, Anchor

FEATURES:

For doors without thresholds
(not undercut)

OPTIONS:

Exterior Pack screw packs;
stainless steel plated to
match – use EXP suffix
(441 x EXP) when ordering

AVAILABLE FINISHES:

- US3/605
- US4/606
- US10/612
- US10B/613
- 10BE/613E
- US15/619
- US26/625
- **US26D/626**
- BSP (Black Suede Powder Coat)
- WSP (White Suede Powder Coat)
- BPC (Black Powder Coat)
- WPC (White Powder Coat)
- FBPC (Flat Black Powder Coat)

Size:

Base: \varnothing 1 7/8" x 1/4" h

Height: 1 1/8"

Weight:

2.1 lbs./10

WARNING

This product can expose
you to lead which is known
to the state of California to
cause cancer and birth defects
or other reproductive harm.
For more information go to
www.P65warnings.ca.gov.

Rockwood Manufacturing Company
300 Main St.
Rockwood, PA 15557
www.rockwoodmfg.com
1 800 458 2424

Copyright © 2019-2024, ASSA ABLOY Accessories and Door Controls Group, Inc. All rights reserved. Reproduction in whole or in part without the express written permission of ASSA ABLOY Accessories and Door Controls Group, Inc. is prohibited. Printed in the U.S.A.

DPS Door Position Switches



DPS-W and DPS-M door position switches enable access control systems to monitor the open or closed state of a door.

These switches can transmit an initiate signal to XDT delayed exit logic timers and DPA door prop logic timers.

Features

Standard Features

- Mated magnetic switch and cylindrical magnetic contact
- Recesses into door and frame
- 3/4" [19mm] round installation, 15/16" [23.8125mm] deep
- Provides normally closed SPST switch
- Works with door gap up to 3/4" [18mm]
- Larger cylindrical magnet counters shielding effect of steel
- MagnaCare® lifetime replacement, no-fault, no questions asked warranty

Optional Features

- Available in white, gray or black

Specifications

Electrical

- Switching Current AC/DC (max): 0.4 A

Environmental

- Operating Temperature: -40° to 150° F [-40° to 65° C]

How to Order

MODEL SERIES	DOOR TYPE	FINISH
DPS	- M	- BK
DPS Door Position Switch	M Metal Door	BK Black
	W Wood Door	GY Gray
		WH White



MagnaCare
Warranty

Warranty Policy

In 1999 Securitron introduced the first no-fault, no questions asked warranty to the industry, MagnaCare®. We believe that the best products in the industry should be supported by our commitment to deliver the highest quality products and services. Securitron is proud to now extend the most comprehensive no-fault, no questions asked warranty coverage to all of our products and solutions. This is our expectation and commitment to you – our valued customer.



MagnaCare Warranty

Duration: Lifetime

Condition: Any reason, including, but not limited to, installation error, vandalism or force majeure.

Replacement: Replacement product or equivalent shipped at Securitron expense via next day air freight in most cases.

Products Covered:

- Electromagnetic and Specialty Locks
- Power Supplies (excluding BPSS) and Power Transfers
- Push Buttons, Keypads, Key Switches and Egress Devices

Check your individual product to determine warranty coverage. Batteries and consumables are not covered by Securitron Warranty programs. Replacement products, at Securitron's sole option, may be the identical item or a unit which serves as a functional replacement. If the customer has an account with Securitron or a valid credit card, the customer may order an advance replacement product, whereby Securitron will charge the customer's account for the price of the product plus next day air freight, and will credit back to the customer the full amount of the charge, including outbound freight, upon Securitron's receipt of the original product from the customer. Securitron's sole and exclusive liability, and customer's sole remedy, is limited to the replacement of the Securitron product when delivered to Securitron's facility (freight and insurance charges prepaid by customer).



SecuriCare 3-year Warranty

Duration: Three years from date of shipment

Condition: Any reason, including but not limited to, installation error, vandalism or force majeure

Replacement: Replacement product or equivalent shipped at Securitron's expense via next day air freight in most cases.

Products Covered:

- DR100 and R100 Aperio® Wireless Card Readers
- BPSS Solar Power Supplies
- GL1 Gate Lock & Accessories
- Accessories

Securitron AQ Series Power Supplies

ASSA ABLOY

The global leader in
door opening solutions



Discover ASSA ABLOY Power.
With a wide range of power supplies,
Securitron has the right power solution to
protect and enhance the performance
of access control devices.

Mix & Match UL Listing

- Available in one to 16 Amp variants to support the smallest single door systems to the largest enterprise access control systems
- UL listed dynamic field configurable product offering
- Combine any of the seven power supplies and nine distribution boards in any UL listed enclosure and maintain UL code compliance

Protection & Efficiency

- Heavily filtered and regulated output provides better-than-linear performance
- Up to 93% efficiency, which results in decreased operating costs and lengthens the lifespan of electronics
- Low battery cutoff protects readers and other sensitive components from undervoltage

Friendly & Knowledgeable Support

- Customer Service and Technical Support offer tools and resources to address questions of all shapes and sizes
- Free, custom wiring diagram support available
- No-fault, no questions asked warranty covers installation errors



MagnaCare
Warranty



Dual Voltage
12/24

Specifications

Certifications (Both)

- UL294 Listed
- UL603 Listed
- ULC-S318 Listed
- ULC-S533 Listed
- RoHS Compliant
- REACH Compliant
- CE Compliant

Dimensions

- 14" x 14" x 4-3/4" [355.6mm x 355.6mm x 120.65mm]

Shipping Weight

- 12.7 lbs [5.76kg]

Electrical

- 115 or 230 VAC input (except AQD1)
- Supports up to two (2) sealed gel, AGM or wet lead acid batteries
- Up to 93% efficiency
- Low noise design with ripple as low as 70mV p-p
- Outputs are Class 2 limited when used with PTC polyswitch distribution boards
- Dual voltage 12 or 24 VDC field selectable continuous output
- Single voltage 12 or 24 VDC continuous output

Operating Temperature

- -4° to 122°F [-20° to 50°C]

Features

- All combinations of AQ power supplies and distribution boards are UL Listed
- Tolerates brownout or over-voltage input $\pm 15\%$ of nominal voltage
- Thermal shutdown protection with auto restart
- Circuit breaker protects against over-current and reverse battery faults
- Dedicated battery charging circuit* prevents over-voltage on locking devices
- Expandable up to 16 outputs in the standard enclosure
- Available with a single relay fire trigger or individually triggered relayed outputs
- Low battery cutoff at 9V

*Except AQD1. Battery disconnect module available. Please contact the factory.

How To Order

Select a power supply and up to two distribution boards in the 14" x 14" enclosure. All combinations of power supplies and distribution boards are UL Listed and are available in a number of possible configurations. Use the tables below to build the right solution for your needs.

Model Series	Output Type	Voltage	Output Power	Enclosure Style	Number of Outputs	Fuse Type	Number of Relays	Relays	Fuse Size
AQ	D		6	-	8	F	8	R	2
AQ	D Dual Voltage *	Blank Dual Voltage *	1 *	- In Enclosure		Blank	One Output, No Distribution Board		
	S Single Voltage **	12 12VDC **	2 *	B Circuit Board Only	4	F Glass + Fuses	1	R Relays	1 1 Amp
		24 24VDC **	4 *		8	C PTC + Polyswitch	2		2 2 Amp
			6 *		12		8		
			10 **		16		9		
			16 **				16		

Not every combination above is possible: *Dual Voltage Option Only **Single Voltage Option Only + Fuse type and size must be the same for both distribution boards for standard ordering. For custom configurations, please contact the factory at 800.626.7590.

ElectroLynx® Retrofit Cables

If you are not ordering ASSA ABLOY Door Group doors with the ElectroLynx® cable pre-installed in the door, you must order an ElectroLynx® retrofit cable to go between ANY hardware and the hinge. This includes 3" cables to go from the hinge to an exit device and up to a 15' cable to go up and around a full lite metal door.



QC-C1500P Shown

Standard ElectroLynx® Retrofit Cable Sizes

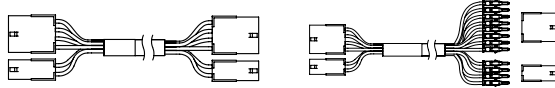

Actual Cable Length	12 Conductor and Molex both ends	12 Conductor and Molex one end, pinned one end	Typical Application
3"	QC-C003	QC-C003P	
6"	QC-C006	QC-C006P	Between hinge and the end of an exit device.
12"	QC-C012	QC-C012P	
26"	QC-C200	QC-C200P	
32"	QC-C206	QC-C206P	
38"	QC-C300	QC-C300P	Between hinge and through the door to the lockset or exit device trim.
44"	QC-C306	QC-C306P	
50"	QC-C400	QC-C400P	
15' 2"	QC-C1500	QC-C1500P	From the hinge location, up the jamb to above the ceiling, or up and around full lite or half lite metal door.
25'	-	QC-C2500P	
30'	-	QC-C3000P	

Custom lengths available.



Experience a safer and more open world

800-346-7707 | www.mckinneyhinge.com
Check the web site for the up-to-date catalog

McKinney is a brand associated with Corbin Russwin, Inc., an ASSA ABLOY Group company. Copyright © 2012-2023, Corbin Russwin, Inc. All rights reserved. Reproduction in whole or in part without the express written permission of Corbin Russwin, Inc. is prohibited.

Architectural Door Accessories

ASSA ABLOY

Pemko Door Bottoms:
Door Top Weatherstrip

The global leader in
door opening solutions

346_

AVAILABLE FINISHES: C, D, G, PW

WIDTH: 2-1/2" (63.5 mm)

HEIGHT: 5/8" (15.9 mm)

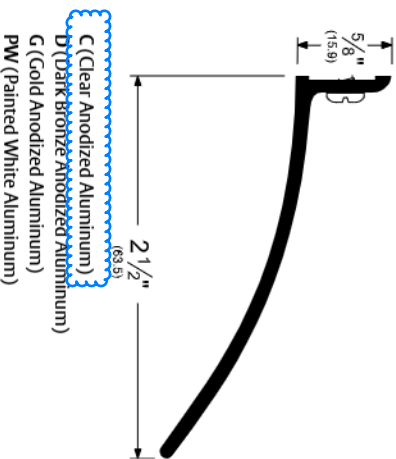

Copyright © 2017, Pemko Manufacturing Co., an ASSA ABLOY Group company. All rights reserved.
Reproduction in whole or in part without the express written permission of Pemko Manufacturing Co. is prohibited.

TITLE:
PREPARED FOR:
PREPARED BY:
DATE:
COMMENTS:

346_CUT Rev 1 - 02.09.17

Architectural Door Accessories

ASSA ABLOY

Pemko Adhesive Gasketing:
Siliconseal™ Adhesive-backed
Fire/Smoke Gasketing

The global leader in
door opening solutions

S88



AVAILABLE FINISHES: BL, C, D, GR, TAN, W
AVAILABLE LENGTHS: 17', 18', 20', 21', 25', 30', 204'
WIDTH: 1/2" (12.7 mm)
HEIGHT: 1/4" (6.4 mm)

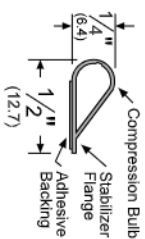

- BL (Black)
- C (Clear)
- D (Dark Brown)
- GR (Gray)
- TAN (Tan)
- W (White)

Copyright © 2017, Pemko Manufacturing Co., an ASSA ABLOY Group company. All rights reserved.
Reproduction in whole or in part without the express written permission of Pemko Manufacturing Co. is prohibited.

TITLE:
PREPARED FOR:
PREPARED BY:
DATE:
COMMENTS:

S88_CUT Rev 1 - 05.31.17

Architectural Door Accessories



Pemko Door Bottoms:
Door Bottom Sweeps

315_N



AVAILABLE FINISHES: B, C, D, G, PW, SN

WIDTH: 1/4" (6.4 mm)

PROFILE HEIGHT: 1-1/4" (31.8 mm)

TOTAL HEIGHT WITH INSERT: 1-11/16" (42.9 mm)

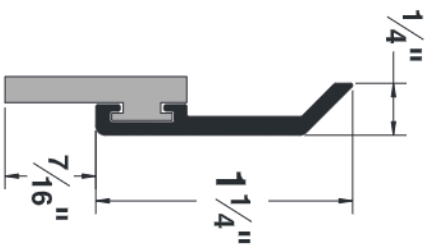

- B (Mill Finish, Extruded Bronze (Brass))
- C (Clear Anodized Aluminum)
- D (Dark Bronze Anodized Aluminum)
- G (Gold Anodized Aluminum)
- PW (Painted White Aluminum)
- SN (Satin Nickel Anodized Aluminum)

Copyright © 2017, 2019, ASSA ABLOY Accessories and Door Controls Group, Inc. All rights reserved. Reproduction in whole or in part without the express written permission of ASSA ABLOY Accessories and Door Controls Group, Inc. is prohibited.

TITLE:	
PREPARED FOR:	
PREPARED BY:	
DATE:	
COMMENTS:	

315_N_CUT Rev 4 - 07.09.19

Architectural Door Accessories

ASSA ABLOY

Pemko Commercial Thresholds:
Latching Panic Exit Saddles

The global leader in
door opening solutions

2005_T



AVAILABLE FINISHES: A, B, D, G
WIDTH: 5" (127.0 mm)
HEIGHT: 1 1/2" (12.7 mm)

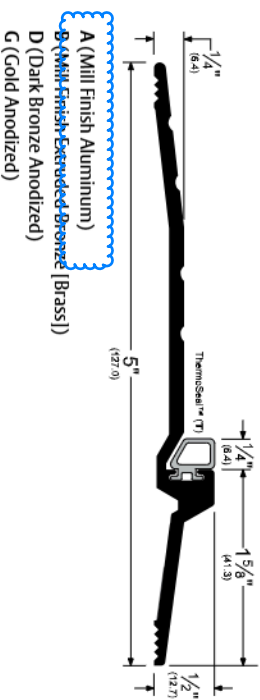

Copyright © 2017, Pemko Manufacturing Co., an ASSA ABLOY Group company. All rights reserved.
Reproduction in whole or in part without the express written permission of Pemko Manufacturing Co. is prohibited.

TITLE:	
PREPARED FOR:	
PREPARED BY:	
DATE:	
COMMENTS:	

2005_T_CUT Rev 2 - 05.17.17

Rockwood 608-RKW

Door Silencer

Experience a safer
and more open world



SPECIFICATIONS:

MATERIAL:
Rubber

OTHER:
Sold in packages of 100

AVAILABLE FINISHES:

- Gray (Standard)
- Black

Size:
1/2" x 5/8"

Weight:
1.3 lbs./500

Frame Type:
Metal

Rockwood Manufacturing Company
300 Main St.
Rockwood, PA 15557
www.rockwoodmfg.com
1 800 458 2424

Copyright © 2019-2025, ASSA ABLOY Accessories and Door Controls Group, Inc. All rights reserved. Reproduction in whole or in part without the express written permission of ASSA ABLOY Accessories and Door Controls Group, Inc. is prohibited. Printed in the U.S.A.

To Whom It May Concern:

McKinney, established in 1864 is renowned for products that are guaranteed to be free of defects in both workmanship and materials for a period of one years from purchase. Any bending, defacing or modification of our product after leaving the factory will void the warranty. Liability shall be limited to the replacement of product or component determined to be defective and shall not include costs arising from removal or reinstallation of product. Cost of replacement shall not exceed original purchase price

Written notice of damages must occur within the warranty period. A factory generated Return Goods Authorization will be provided as no goods will be accepted without prior approval. These defective goods must be returned to our factory in Berlin, CT., unless specified otherwise. Freight charges must be pre-paid unless noted otherwise.

This guarantee is only valid if the products are specified, applied and adjusted in accordance with the instructions contained in the General Information Section of the McKinney catalog and on frames and doors that are plumb and square.

Please be advised that we do not have operation or MSDS Sheets for our products as they do not pertain.

The McKinney Products Company

Architectural Accessories and
Door Controls Group
225 Episcopal Road
Berlin, CT 06037

Phone: +1 860 828 7215
Mobile: +1 860 335 1903
Fax: +1 800 541 1037
Website: www.mckinneyhinge.com

Markar & Pemko Warranty:

Pemko products are guaranteed for (5) years against defects in material or workmanship, except: 1) PemKote abrasive surface for thresholds is guaranteed for ten (10) years. 2) Polyurethane foam tapes are guaranteed for 90 days. 3) Grade 1 PemkoHinges are guaranteed for the life of the opening against defects in material or workmanship. All other grades of PemkoHinge carry a ten (10) year warranty. 4) Electrical modification performance is guaranteed for five (5) years on Heavy Duty Grade 1 (HDI) and 1100 Series hinges. Electrical modification performance is guaranteed for one (1) year on Standard Duty and Heavy Duty Grade 3 (HD3) hinges. 5) PC Henderson products are guaranteed for two (2) years against defects in material workmanship. 6) Powder Coated finishes are warranted for two (2) years; normal wear is not included in coverage.

Markar Continuous Hinges and Pivots are guaranteed to be free from defects in materials and workmanship for a period of 10 years. Hinges with medical bearings are guaranteed for twenty-five (25) years. Markar Edge Guards and Astragals are guaranteed to be free from defects in materials and workmanship for a period of (1) year. Markar electrical modification performance is guaranteed for five (5) years.

ASSA ABLOY will not be liable for defects or damages arising from improper installation, product modification, incorrect application or storage of product. Written notice of damages must occur within the warranty period. Liability shall be limited to the replacement of product or component determined to be defective and shall not include costs arising from removal or reinstallation of product. Cost of replacement shall not exceed original purchase price. No other claims will be allowed. In no event shall liability be extended to include punitive, incidental or consequential damages arising from use of ASSA ABLOY products. This is the sole warranty given by ASSA ABLOY. No other warranty implied or expressed shall be allowed.

Limited Warranty

Corbin Russwin, Inc. (Company) warrants that its products sold under the Corbin Russwin and Design® trade name in the United States of America are free from defects in workmanship and materials under normal use and service. This warranty does not cover defects or damage arising from improper installation, lack of or improper maintenance, improper storage, shipping and handling, corrosion, erosion, ordinary wear and tear, misuse, abuse, accident, unauthorized service, or use with unauthorized non-Corbin Russwin products or parts. This warranty is void if any modification is made to the warranty product, regardless of whether the modification causes or contributes to the alleged defect. All modifications are made at the risk of the party making the modification.

The only liability of the Company in tort or contract whether under this warranty or otherwise shall be limited to the repair or replacement of any product or component part which shall prove defective as covered by this warranty, within the stated time frame listed below, after delivery to the original purchaser.

DC6200 & DC6400 Series Door Closers	30 years
DC8000 Series Door Closers.....	30 years
DC3200 Series Door Closers.....	15 years
DC5000 Series Door Closers.....	10 years
ML2000 Series Mortise Locksets.....	10 years
CL3100 Series Cylindrical Locksets	10 years
CLX3300 Series Cylindrical Locksets	10 years
CL3300/CL3500/CL3800 Series Cylindrical Locksets	7 years
FE5400S/FE6700/FE6800/MP6600/BL6600 Series Multi-point Locksets	7 years
ED4000, ED5000 Series Exit Devices, MELR Option & 900 Series Trim	5 years
MP9800 Series	5 years
Pyramid Cylinders.....	5 years
CK4300 Series Cylindrical Knob Locksets.....	3 years
All Electro-mechanical and electronic products.....	2 years
Electrified Exit Devices.....	2 years
Access 3 Cylinders.....	1 year
All Other Locksets	1 year
All Other Exit Device Trim.....	1 year
All Other Corbin Russwin Products.....	1 year
ED3000, ED7000, ED8000 Series Exit Devices & Trim.....	1 year
MicroShield® Finish	1 year

Finishes:

Corbin Russwin finishes are covered by a limited warranty period of one year after invoice date.

Warranty Requirements for Cylinders Factory or Field Combined:

Cylinders are lubricated at the factory with a petroleum based lubricant (Moist-Out / MO-10). Cylinders should be lubricated periodically depending upon environmental conditions. FLUID FILM lubricant is recommended. Never mix petroleum based lubricants with dry lubricants. Corbin Russwin cylinder and/or core warranty will be voided if used in non-Corbin Russwin locking devices.

Warranty Requirements for Cylinders Field Combined:

1. Keys shall be cut to the Corbin Russwin key biting specifications required for the particular keyway and depth system.
2. All pin lengths shall be selected according to prevailing factory standards.
3. Original Corbin Russwin cylinders and cylinder components, including pin tumblers and key blanks, shall be used. We reserve the right to void the warranty if we deem that a malfunction is a result of non-original components which do not conform to Corbin Russwin standards.

Continued on next page

Limited Warranty continued**Keying Systems:**

All bittings shall be originated or authorized by the Corbin Russwin Key Systems Department to be compatible with one another in a specific type of cylinder (Access 3, Pyramid, conventional, security, master ring, interchangeable core) and within a particular keying system. Product repair or replacement, or associated charges, will not be accepted under this warranty unless prior authorization from Corbin Russwin has been given. Upon receipt of products returned for repair or replacement, we will determine whether products qualify for repair or replacement under this warranty. If they do not, we will obtain authorization prior to proceeding. We have no liability to pay any costs of repair performed by anyone other than qualified personnel authorized by Corbin Russwin prior to the work being done.

The Company will not pay for the cost of repair performed other than in accordance with this warranty. Written notice of a product or component part believed to be defective as covered by this warranty should be sent to Corbin Russwin, Inc. 225 Episcopal Road, Berlin, CT 06037, and should include your name and address, an identification of the product or component part and a brief description of the defect. Upon receipt of such notice, the Company will inform you where to ship such product or component part, shipping charges prepaid, for examination and, in the event such examination reveals defect covered by this warranty, the product will be repaired or replaced. The Company reserves the right to replace discontinued product with an equivalent product as deemed by the Company.

THIS WARRANTY IS IN LIEU OF ALL OTHER EXPRESS WARRANTIES. TO THE EXTENT PERMITTED BY LAW, ALL IMPLIED WARRANTIES ARE LIMITED TO THE DURATION OF THIS WARRANTY. CORBIN RUSSWIN, INC. SHALL NOT BE LIABLE FOR ANY INCIDENTAL OR CONSEQUENTIAL DAMAGES. NO AGENT, SALES REPRESENTATIVE OR DEALER HAS THE AUTHORITY TO INCREASE OR ALTER THE OBLIGATIONS OF THIS WARRANTY. SOME STATES DO NOT ALLOW LIMITATIONS ON HOW LONG AN IMPLIED WARRANTY LASTS OR THE EXCLUSION OR LIMITATION OF INCIDENTAL OR CONSEQUENTIAL DAMAGES, SO THE ABOVE LIMITATION OR EXCLUSIONS MAY NOT APPLY TO YOU. THIS WARRANTY GIVES YOU SPECIFIC LEGAL RIGHTS, AND YOU MAY ALSO HAVE OTHER RIGHTS WHICH VARY FROM STATE TO STATE.



ASSA ABLOY

Limited Warranty

ASSA ABLOY Accessories and Door Controls Group, Inc. (the "Company") warrants that its products sold under the Norton Rixson trade name in the United States of America are free from defects in workmanship and materials under normal use and service.

This warranty does not cover defects or damage arising from improper installation, lack of or improper maintenance, improper storage, shipping and handling, ordinary wear and tear, misuse, abuse, accident, unauthorized service, use with unauthorized non-Norton Rixson products or parts, or the effects of erosion, or corrosion on the finish. This warranty is void if any modification is made to the product, regardless of whether the modification causes or contributes to the alleged defect. All modifications are made at the risk of the party making modification.

The only liability of the Company in tort or contract whether under this warranty or otherwise shall be limited to the repair or replacement of any product or component part which shall prove defective as covered by this warranty. This warranty does not cover, and the Company is not responsible for, any labor charges or others costs and expenses associated with removal and reinstallation of products, or maintenance or other adjustments to the products. The warranty period after delivery to the original purchaser in all cases is as follows:

Surface Closers		
7500, 8000, 1600, 9500, 9540 Series	30 years*	2 years
78BJ/F, 210, 410, 2800ST	10 years	2 years
160, 1700	5 years	2 years
9300BC (discontinued Mar 2023)	5 years	2 years
Floor Closers		
27, 28, 30, 40 Series	10 years	2 years
50, 51, 53 Series	2 years	2 years
10, 12, 15, 16 (discontinued Apr 2022)	2 years	2 years
Gate Closers		
354, 355, 356, 357, 359, 1351	2 years	2 years
Overhead Concealed Closers		
91, 93, 73	15 years	2 years
7900 Series	10 years	2 years
0608, 608, 700, 800 Series	2 years	2 years
Electromechanical Closers		
7100SZ, 7200, 7700PT		2 years
0600, 0601, 0602, 0100, 0101		2 years
4 Pull, 4 Push (discontinued Dec 2022)		2 years
99-726, 99-926		2 years
Low Energy Operators		
6300, 6200, 6000, 5800, 5700, 5500, 5200		2 years
5600 (discontinued Aug 2023)		1 year
Electromagnetic Door Holder/Releases		
Checkmate® Stops & Holders		2 years
Pivots & Pivot Sets		2 years
Thresholds (discontinued Dec 2022)		2 years

The Company will not pay for the cost of repair performed other than in accordance with this warranty. Written notice of a product or component part believed to be defective as covered by this warranty should be sent to Norton Rixson, 3000 Highway 74 E. Monroe, NC 28112, and should include your name and address, an identification of the product or component part and a brief description of the defect. Upon receipt of such notice, the Company will inform you where to ship such product or component part, shipping charges prepaid, for examination and, in the event such examination reveals a defect covered by this warranty, the product will be repaired or replaced.

This warranty is in lieu of all other express warranties. To the extent permitted by law, all implied warranties are limited to the duration of this warranty. ASSA ABLOY Accessories and Door Controls Group, Inc. shall not be liable for any incidental or consequential damages.

SOME STATES DO NOT ALLOW LIMITATIONS ON HOW LONG AN IMPLIED WARRANTY LASTS OR THE EXCLUSION OR LIMITATION OF INCIDENTAL OR CONSEQUENTIAL DAMAGES, SO THE ABOVE LIMITATIONS OR EXCLUSIONS MAY NOT APPLY TO YOU.

THIS WARRANTY GIVES YOU SPECIFIC LEGAL RIGHTS, AND YOU MAY ALSO HAVE OTHER RIGHTS WHICH VARY FROM STATE TO STATE.

**Experience a safer
and more open world**

* Closers must be manufactured after May 1, 2021.
(Closers manufactured from April 2013 until April 2021 = 25 year warranty, prior to April 2013 = 10 year warranty)

For more specific warranty information, please contact us at:
Norton Rixson - 3000 Highway 74 E. Monroe, NC 28112 USA
Tel: 877-974-2255 · www.nortonrixson.com

General Warranty:

Rockwood Manufacturing Company {"Rockwood"}) warrants to purchasers of Rockwood Products sold in the United States of America that its products when properly delivered, installed and maintained, under normal use and service conditions, will be free from defects in material and workmanship for a period of one year from the date of delivery. Because of variations in atmospheric and climatic conditions, Rockwood does not warrant that its products will maintain a "like new" appearance for any length of time, so this warranty does not extend to the appearance of Rockwood's products. Rockwood shall have no responsibility other than the repair or replacement of defective products.

Purchasers should contact Rockwood upon receipt of any product claimed to be defective. If an in-plant inspection is necessary, purchasers should obtain a Return Goods Authorization and then send the product freight paid to Rockwood. If, upon inspection, the product is determined by Rockwood to be in violation of this warranty, Rockwood will repair or replace the defective product promptly.

There are no other express or implied warranties of Rockwood's products.

THE FOREGOING WARRANTY IS IN LIEU OF ANY AND ALL OTHER WARRANTIES, EXPRESS OR IMPLIED, INCLUDING BUT NOT LIMITED TO THE WARRANTIES OF MERCHANTABILITY AND FITNESS FOR A PARTICULAR PURPOSE, ARE HEREBY EXCLUDED. IN NO CIRCUMSTANCES WILL ROCKWOOD BE LIABLE FOR INCIDENTAL OR CONSEQUENTIAL DAMAGES RESULTING FROM THE USE OR SALE OF ITS PRODUCTS OR ARISING OUT OF A BREACH OF ITS WARRANTY OF ITS PRODUCTS.

The foregoing limitations and exclusions are intended to be effective to the maximum extent of the law.