

**FEATURES**

- Brass construction
- Traditional styling
- Completes Revival faucet line

**COLORS/FINISHES**

- CP Polished Chrome
- PB Polished Brass
- Other Refer to Faucets Price Book for additional finishes

**SPECIFIED MODEL:**

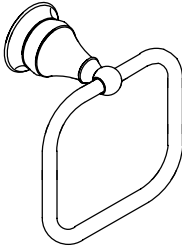
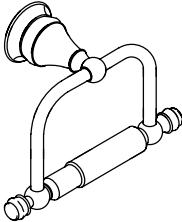
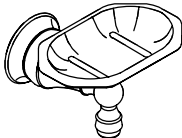
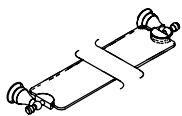
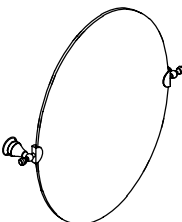
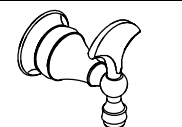
Model/Description	
K-16140 Revival Towel Ring  <input type="checkbox"/> CP <input type="checkbox"/> PB <input type="checkbox"/> Other_____	
K-16141 Revival Toilet Tissue Holder  <input type="checkbox"/> CP <input type="checkbox"/> PB <input type="checkbox"/> Other_____	
K-16142 Revival Soap Dish  <input type="checkbox"/> CP <input type="checkbox"/> PB <input type="checkbox"/> Other_____	
K-16143 Revival Glass Shelf  <input type="checkbox"/> CP <input type="checkbox"/> PB <input type="checkbox"/> Other_____	
K-16145 Revival Oval Mirror; includes pivot mounting brackets  <input type="checkbox"/> CP <input type="checkbox"/> PB <input type="checkbox"/> Other_____	
K-16146 Revival Robe Hook  <input type="checkbox"/> CP <input type="checkbox"/> PB <input type="checkbox"/> Other_____	

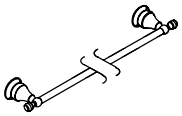
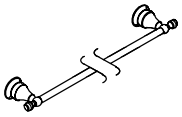
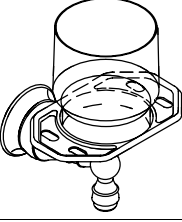
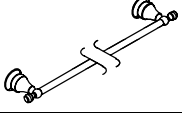
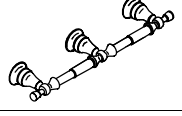
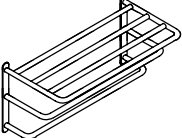
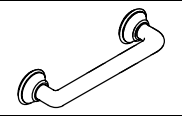
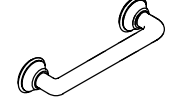
Model/Description	
K-16147 Revival 30" Towel Bar  <input type="checkbox"/> CP <input type="checkbox"/> PB <input type="checkbox"/> Other_____	
K-16148 Revival 18" Towel Bar  <input type="checkbox"/> CP <input type="checkbox"/> PB <input type="checkbox"/> Other_____	
K-16149 Revival Tumbler and Toothbrush Holder; includes glass tumbler  <input type="checkbox"/> CP <input type="checkbox"/> PB <input type="checkbox"/> Other_____	
K-16150 Revival 24" Towel Bar  <input type="checkbox"/> CP <input type="checkbox"/> PB <input type="checkbox"/> Other_____	
K-16152 Revival 14" Double Toilet Tissue Holder  <input type="checkbox"/> CP <input type="checkbox"/> PB <input type="checkbox"/> Other_____	
K-16155 Revival Towel Shelf  <input type="checkbox"/> CP <input type="checkbox"/> PB	
K-16156 Revival 12" Grab Bar  <input type="checkbox"/> CP <input type="checkbox"/> PB <input type="checkbox"/> Other_____	
K-16158 Revival 18" Grab Bar  <input type="checkbox"/> CP <input type="checkbox"/> PB	

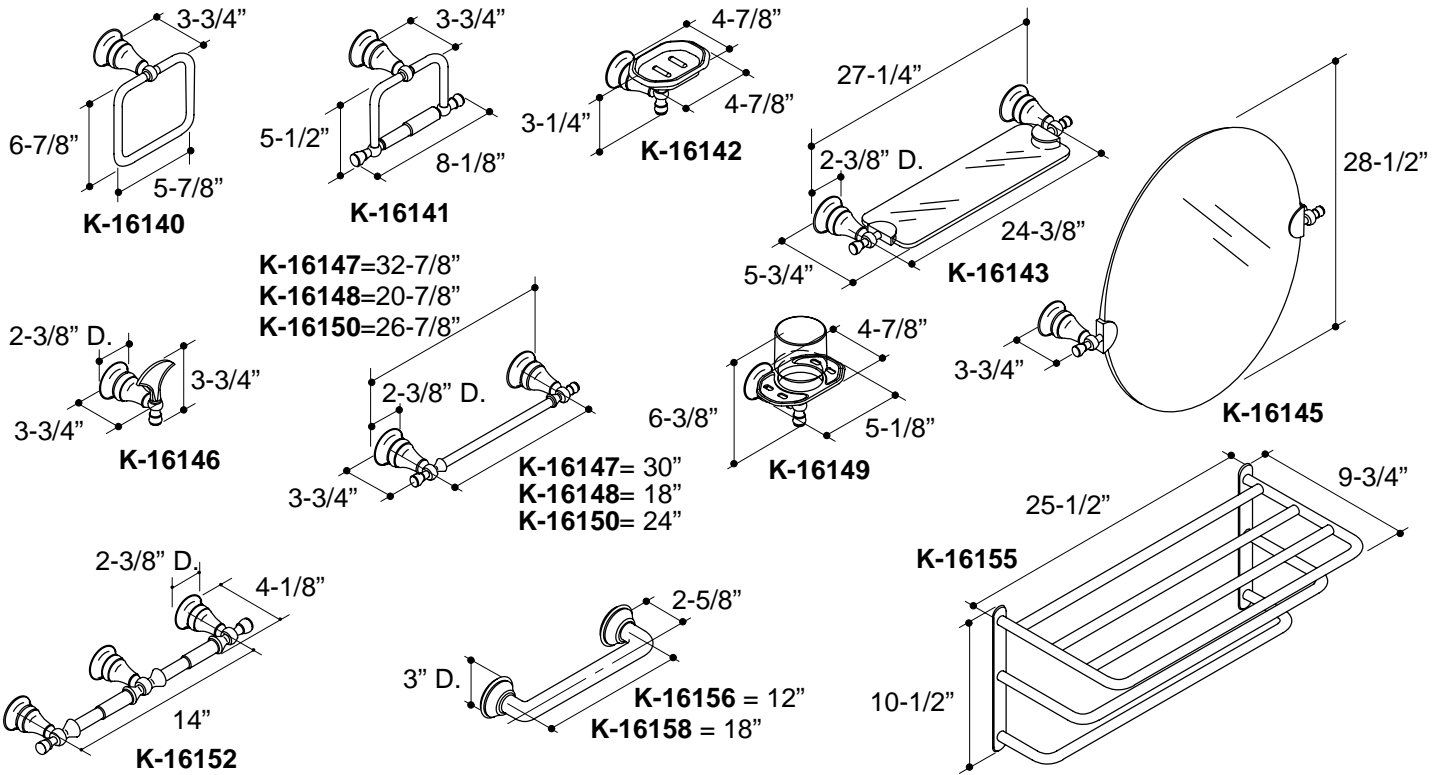

## PRODUCT DIAGRAM