

## Ordering Information

Applicable faucet:	
Square handles	K-6502-2
Lever handles	K-6502-4
<b>ADA</b> Lever handles are ADA compliant	

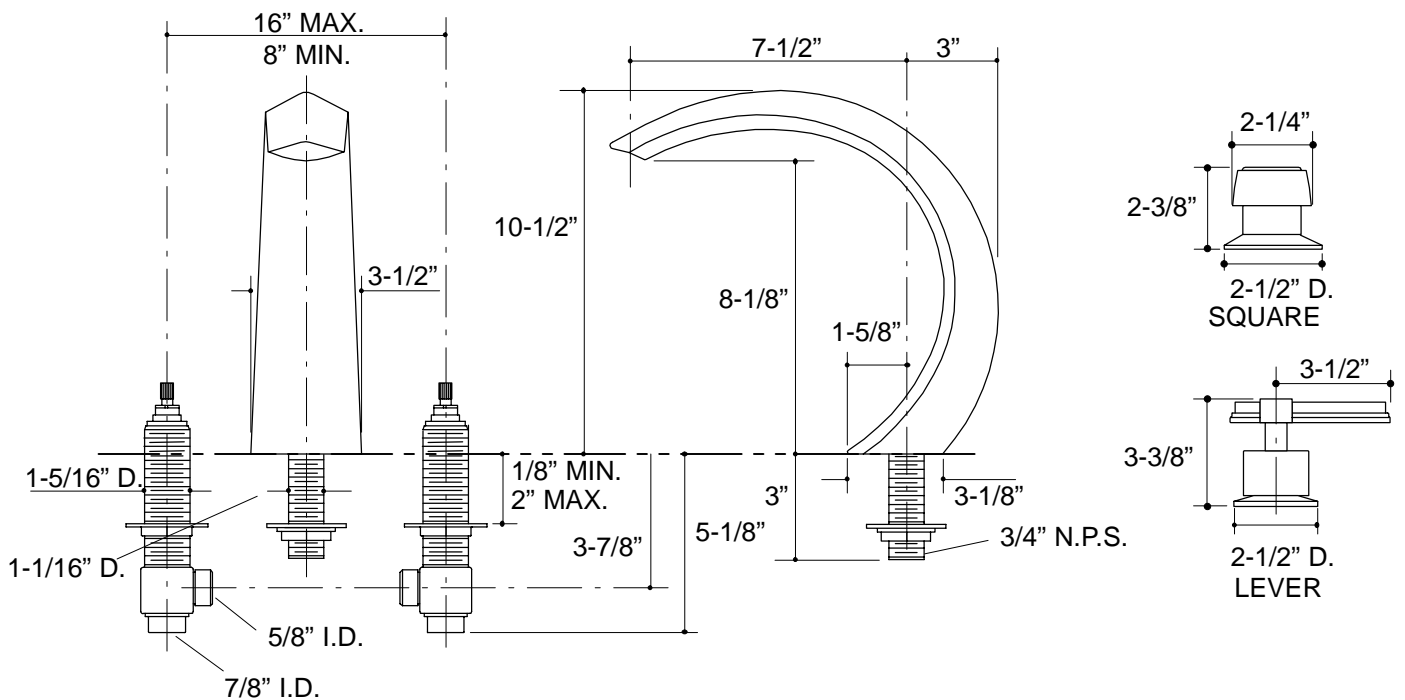

18

**K-6502** Alterna™ Bath Faucet  
113577-1-AA (9619)

**NOTES:**