

Ordering Information

Applicable product:		
203mm centers lavatory	K-2907-8	shown
102mm centers lavatory	K-2907-4	not shown
Single-hole lavatory	K-2907-1	not shown
Accessories/hardware		
Trap	K-8998	recommended

Product Information

ADA compliant.			
Fixture*:		basin area	water depth
Lavatory		483 x 279mm	121mm
Outlet	Ø43mm		
* Approximate measurements for comparison only.			
Holes	K-2907-1	K-2907-4	K-2907-8
Spout	Ø35mm	Ø29mm	Ø29mm
Faucet		Ø30mm	Ø35mm
Included Components:			
Overflow ferrule (1)			44071
Cutout template			114535-7

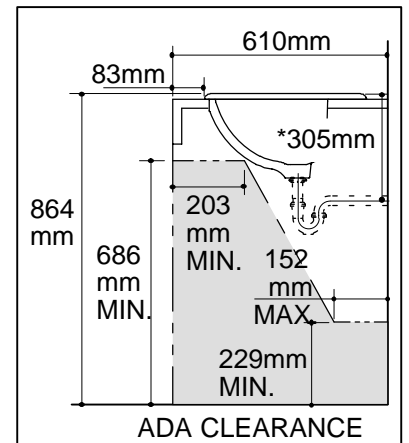
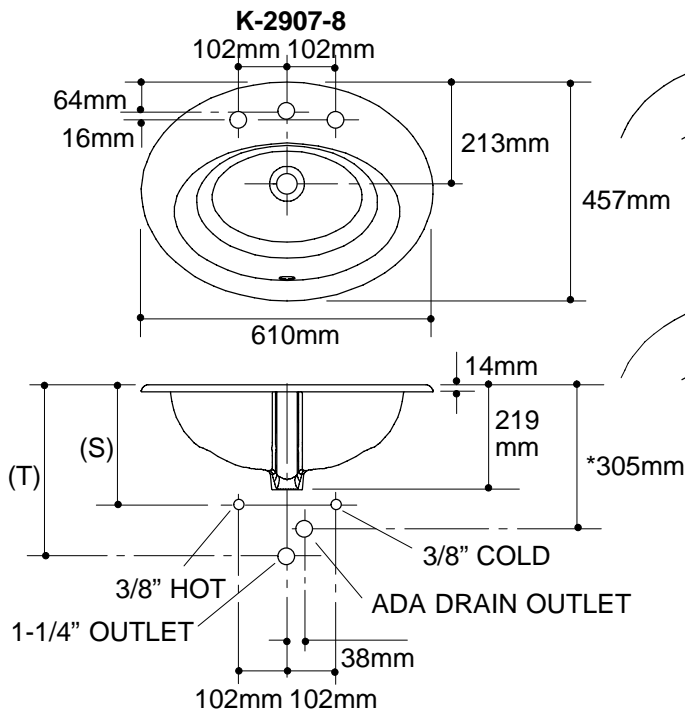

Roughing-In Notes

Fixture dimensions are nominal and conform to tolerances in ASME/ANSI Standard A112.19.1M.

*Based on K-8998 with 25mm of tailpiece exposed.

(T) Pop-up drain 362mm, grid drain 340mm.

Supply (Based on 305mm riser which may require cutting).	K-2907-1, K-2907-4	K-2907-8
(S)	254mm	356mm