

TABLE S601.7 - UPLIFT CONNECTIONS - 140 MPH WINDS EXP "B"
NFCM 2015 TABLE 3.2

CONNECTION	FRAMING SPACING (INCHES)	ROOF SPAN (FEET)	UPLIFT	LATERAL	SHEAR	NUMBER OF 8d COMMON NAILS OR 10d BOX NAILS IN EACH END OF 1-1/4" X 20" GAGE STRAP
ROOF ASSEMBLY TO WALL ASSEMBLY	16" OC	16	401	292	152R	4
WALL ASSEMBLY TO FOUNDATION	16" OC	16	224	219	436	4

TABLE S601.8 - SILL OR BOTTOM PLATE TO FOUNDATION CONNECTIONS RESISTING UPLIFT LOADS - 140 MPH WIND EXP "B"
NFCM 2015 TABLE 3.2C

BOTTOM PLATE TO FOUNDATION ANCHOR BOLT CONNECTION RESISTING UPLIFT LOADS	FOUNDATION SUPPORTING	MAXIMUM ANCHOR BOLT SPACING (INCHES)	
		8' END ZONES	INTERIOR ZONES
UPLIFT LOADS	1 - 3 STORIES	25 INCHES ON CENTER	30 INCHES ON CENTER

TABLE S601.9 - SILL OR BOTTOM PLATE TO FOUNDATION CONNECTIONS RESISTING SHEAR LOADS - 140 MPH WIND EXP "B"
NFCM 2015 TABLE 3.2B

BOTTOM PLATE TO FOUNDATION ANCHOR BOLT CONNECTION RESISTING UPLIFT LOADS	FOUNDATION SUPPORTING	MAXIMUM ANCHOR BOLT SPACING (INCHES)	
		5/8" Ø ANCHOR BOLTS	48 INCHES ON CENTER W/3X3X1/4" WASHER
UPLIFT LOADS	4 STORY		

TABLE S601.10 - FULL HEIGHT STUD REQUIREMENT FOR HEADERS OR WINDOW SILL PLATES IN EXTERIOR WALLS EXPOSURE "B"
NFCM 2015 TABLE 3.23C

HEADER SPAN (FEET)	WALL SPACING (INCHES)		
	12" O.C.	16" O.C.	24" O.C.
2	1	1	1
4	2	2	1
6	3	3	2
8	4	3	2

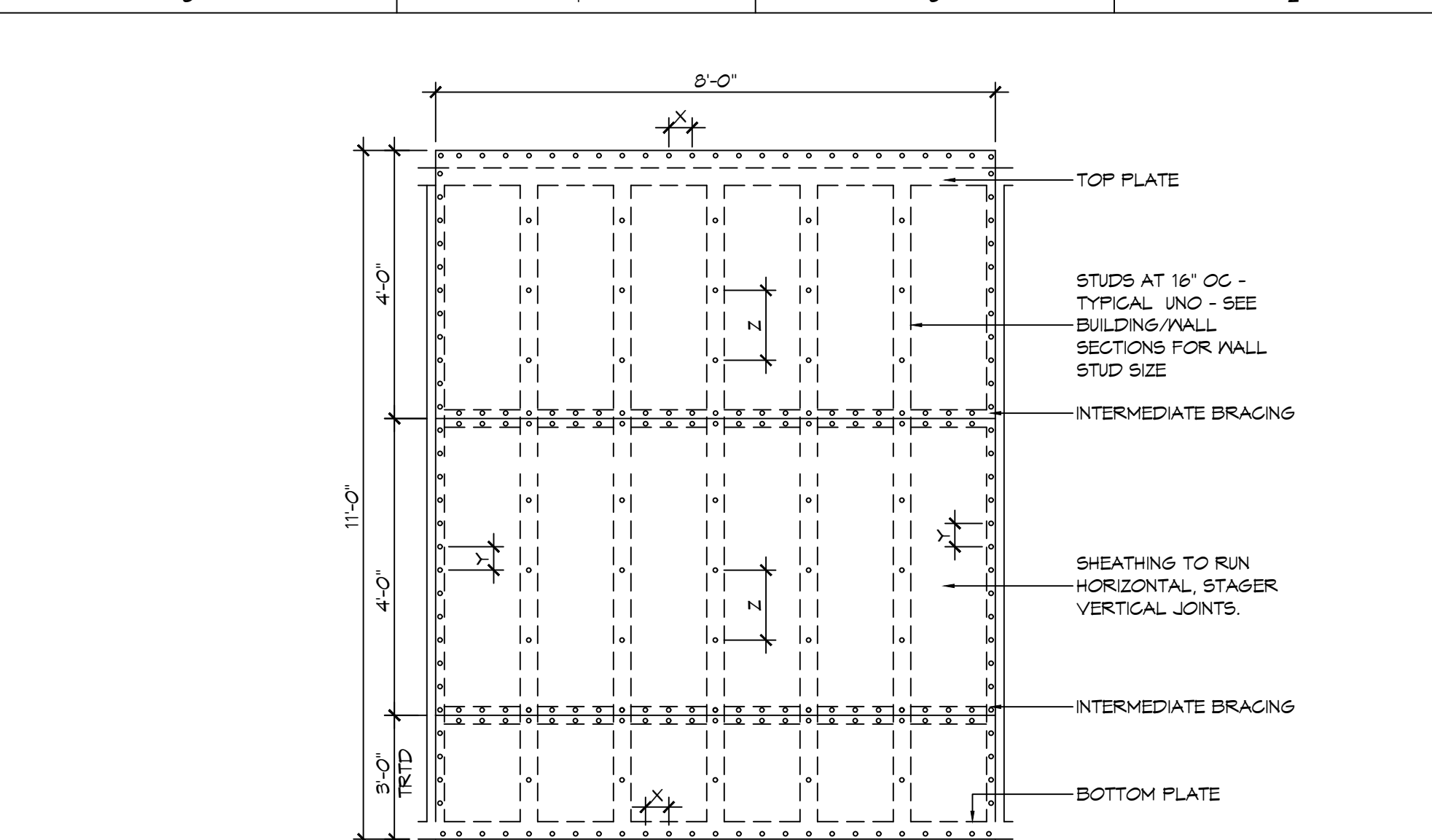

NAIL SPACING
X = 4" OC
Y = 4" OC
Z = 12" OC

X = PLATE EDGE NAIL SPACING
Y = LONG EDGE NAIL SPACING
Z = FIELD NAIL SPACING

INTERIOR SHEATHING
1/2" PLYWOOD EACH FACE STAGGERED 48" OC. W/8d NAILS @ 4" O.C. FASTENING @ PANEL EDGES 8d NAILS @ 12" O.C. FASTENING @ INTERMEDIATE MEMBERS.

EXTERIOR SHEATHING
5/8" PLYWOOD EACH FACE STAGGERED 48" OC. W/8d NAILS @ 4" O.C. FASTENING @ PANEL EDGES 8d NAILS @ 12" O.C. FASTENING @ INTERMEDIATE MEMBERS.

H SHEAR WALL EXTERIOR SHEATHING NAILING PATTERN

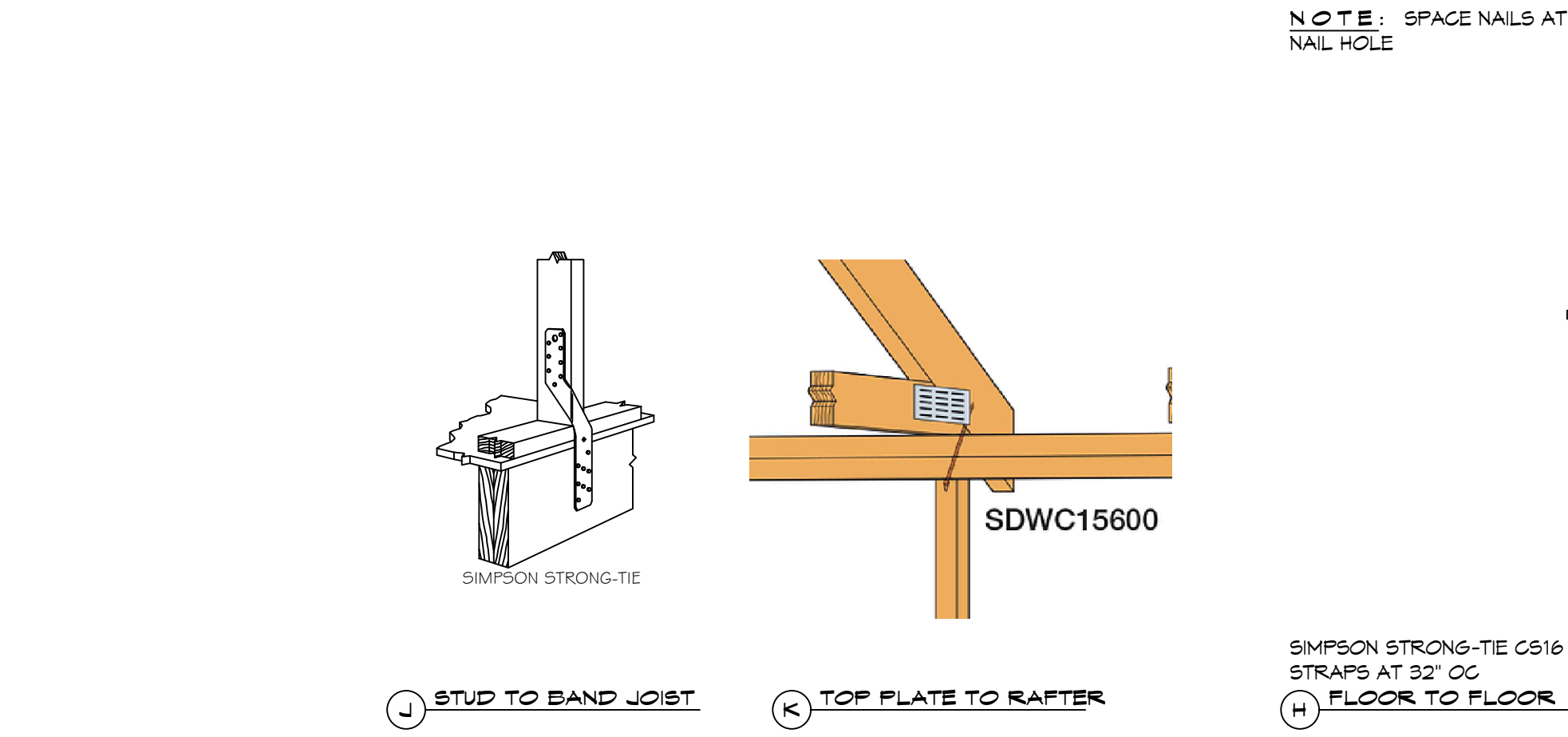

TYPICAL CONNECTION DETAILS
SCALE: NTS

TABLE S601.5 - JACK STUD REQ - INT LOADBEARING WALLS

HEADER SUPPORTING	HEADER SPAN (FT)	ROOF SPAN (FEET)												
		12 FEET				24 FEET				36 FEET				
		3"	4.5"	5"	6.5"	3"	4.5"	5"	6.5"	3"	4.5"	5"	6"	
ONE FLOOR ONLY (CENTER BEARING)	2	1	1	1	1	1	1	1	1	1	1	1	1	
	4	1	1	1	1	1	1	1	1	1	1	1	1	
	6	1	1	1	1	1	1	1	1	2	1	1	1	
	8	1	1	1	1	2	1	1	1	2	2	2	1	
	10	1	1	1	1	2	2	1	1	3	2	2	2	
	12	1	1	1	1	2	2	2	1	3	2	2	2	
	14	2	1	1	1	3	2	2	2	4	3	3	2	
	16	2	2	1	1	3	2	2	2	4	3	3	2	
	TWO FLOORS (CENTER BEARING)	2	1	1	1	1	1	1	1	1	2	1	1	1
		4	1	1	1	1	2	1	1	1	3	2	2	2
6		2	1	1	1	3	2	2	2	4	3	2	2	
8		2	2	1	1	3	2	2	2	5	3	3	3	
10		2	2	2	1	4	3	3	2	6	4	4	3	
12		3	2	2	2	5	3	3	3	7	5	4	4	
14		3	2	2	2	6	4	4	3	8	5	5	4	
16		4	3	2	2	6	4	4	3	9	6	6	5	

TABLE S601.6 - JACK STUD REQ - EXTERIOR LOADBEARING WALLS
NFCM 2021 TABLE 3.22F

ROOF AND CEILING	HEADER WIDTH - 3" (2-2x), 4.5" (3-2x), 5", 6.5" (4-2x) EACH 1/1/2" PLYWOOD SPACER BETWEEN	ROOF LIVE LOAD 20 PSF				ROOF LIVE LOAD 30 PSF					
		3"	4.5"	5"	6.5"	3"	4.5"	5"	6.5"		
		NUMBER OF JACK STUDS REQUIRED									
ROOF AND CEILING	2	1	1	1	1	1	1	1	1	1	
	4	1	1	1	1	1	1	1	1	1	
	6	2	1	1	1	2	1	1	1	1	
	8	2	2	2	1	2	2	2	1	1	
	10	3	2	2	2	3	2	2	2	2	
	12	3	2	2	2	3	2	2	2	2	
	14	4	3	2	2	4	3	2	2	2	
	16	4	3	3	2	4	3	3	2	2	
	ROOF, CEILING, AND ONE CENTER BEARING FLOOR	2	1	1	1	1	1	1	1	1	1
		4	2	1	1	1	2	1	1	1	1
6		2	2	2	1	3	2	2	2	2	
8		3	2	2	2	3	2	2	2	2	
10		4	3	2	2	4	3	3	2	2	
12		4	3	3	2	5	3	3	3	3	
14		5	4	3	3	5	4	3	3	3	
16		6	4	4	3	6	4	4	3	3	

TABLE S601.3 - NAILING SCHEDULE
NFCM 2015 TABLE 3.1

DESCRIPTION	NUMBER OF COMMON NAILS	NUMBER OF BOX NAILS	SPACING

TABLE S601.4 - BUILDING ENVELOPE REQUIREMENTS

ROOFS	OPAQUE ELEMENTS		ASSEMBLY MAXIMUM	INSULATION MIN. R-VALUE
	INSULATION ENTIRELY ABOVE DECK	INSULATION MIN. R-VALUE		
ROOFS	METAL BUILDING	U-0.065	R-19	
	ATTIC AND OTHER	U-0.027	R-30	
	MASS	U-0.151	R-5.7 c.i.	
WALLS, ABOVE GRADE	METAL BUILDING	U-0.113	R-19.0	
	STEEL-FRAMED	U-0.124	R-19.0	
	WOOD-FRAMED AND OTHER	U-0.089	R-19.0	
FLOORS	MASS	U-0.107	R6-3 c.i.	
	STEEL JOIST	U-0.052	R-19.0	
	WOOD FRAMED AND OTHER	U-0.051	R-19.0	
SLAB-ON-GRADE	UN-HEATED	F-0.750	NR	
OPAQUE DOORS	SWINGING	U-0.700	NR	
	NON-SWINGING	U-1.450	NR	

TABLE S601.1 - ROOF SHEATHING ATTACHMENT REQUIREMENT - WIND LOAD EXP "B"

SHEATHING LOCATION	RAFTER / TRUSS SPACING	E F	
		MAX NAIL SPACING FOR 8d COMMON NAILS OR 10d BOX NAILS (INCHES OC)	
INTERIOR ZONE	12" OC	6	12
	16" OC	6	12
	24" OC	6	12
PERIMETER EDGE ZONE	12" OC	6	6
	24" OC	4	4

TABLE S601.1 - WALL SHEATHING AND CLADDING REQUIREMENT - WIND LOAD EXP "B"

SHEATHING LOCATION	RAFTER / TRUSS SPACING	E F	
		MAX NAIL SPACING FOR 8d COMMON NAILS OR 10d BOX NAILS (INCHES OC)	
INTERIOR ZONE	12" OC	6	12
	16" OC	6	12
	24" OC	6	6
PERIMETER EDGE ZONE	12" OC	6	12
	24" OC	6	6

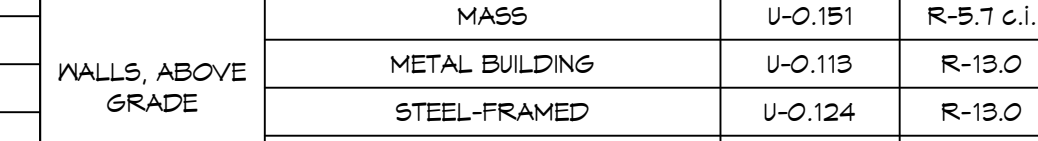

TABLE S601.1 - WALL SHEATHING AND CLADDING REQUIREMENT - WIND LOAD EXP "B"

SHEATHING LOCATION	RAFTER / TRUSS SPACING	E F	
		MAX NAIL SPACING FOR 8d COMMON NAILS OR 10d BOX NAILS (INCHES OC)	
INTERIOR ZONE	12" OC	6	12
	16" OC	6	12
	24" OC	6	6
PERIMETER EDGE ZONE	12" OC	6	12
	24" OC	6	6

TABLE S601.1 - WALL SHEATHING AND CLADDING REQUIREMENT - WIND LOAD EXP "B"

SHEATHING LOCATION	RAFTER / TRUSS SPACING	E F	
		MAX NAIL SPACING FOR 8d COMMON NAILS OR 10d BOX NAILS (INCHES OC)	
INTERIOR ZONE	12" OC	6	12
	16" OC	6	12
	24" OC	6	6
PERIMETER EDGE ZONE	12" OC	6	12
	24" OC	6	6

TABLE S601.1 - WALL SHEATHING AND CLADDING REQUIREMENT - WIND LOAD EXP "B"

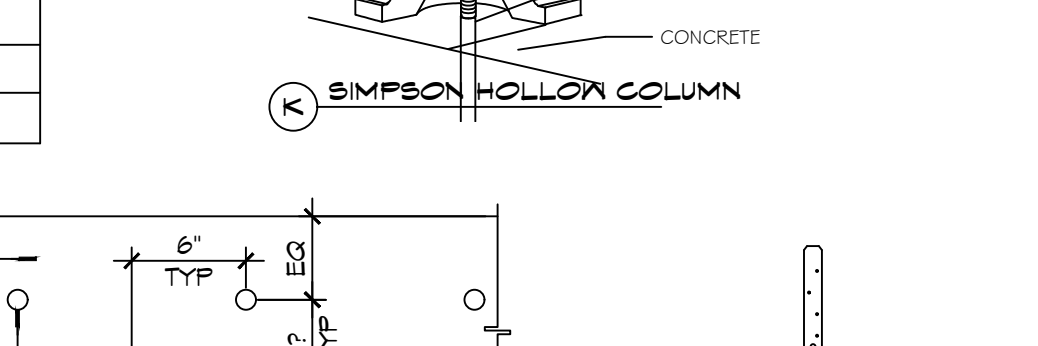

TABLE S601.1 - WALL SHEATHING AND CLADDING REQUIREMENT - WIND LOAD EXP "B"

SHEATHING LOCATION	RAFTER / TRUSS SPACING	E F	
		MAX NAIL SPACING FOR 8d COMMON NAILS OR 10d BOX NAILS (INCHES OC)	
INTERIOR ZONE	12" OC	6	12
	16" OC	6	12
	24" OC	6	6
PERIMETER EDGE ZONE	12" OC	6	12
	24" OC	6	6

TABLE S601.1 - WALL SHEATHING AND CLADDING REQUIREMENT - WIND LOAD EXP "B"

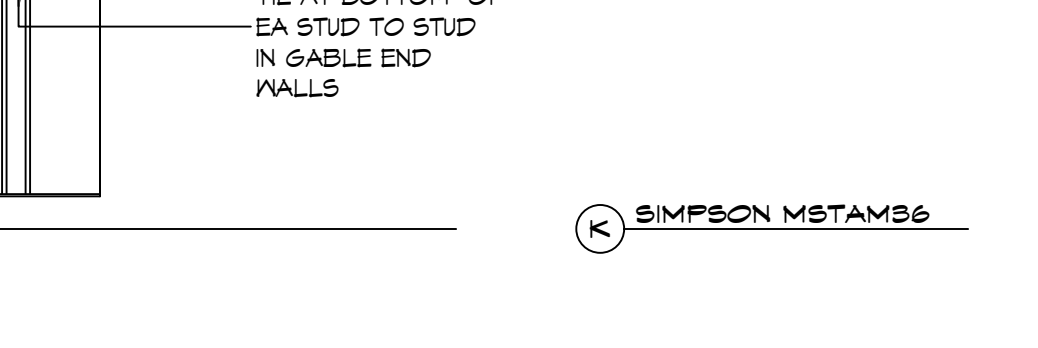

TABLE S601.1 - WALL SHEATHING AND CLADDING REQUIREMENT - WIND LOAD EXP "B"

SHEATHING LOCATION	RAFTER / TRUSS SPACING	E F	
		MAX NAIL SPACING FOR 8d COMMON NAILS OR 10d BOX NAILS (INCHES OC)	
INTERIOR ZONE	12" OC	6	12
	16" OC	6	12
	24" OC	6	6
PERIMETER EDGE ZONE	12" OC	6	12
	24" OC	6	6

TABLE S601.1 - WALL SHEATHING AND CLADDING REQUIREMENT - WIND LOAD EXP "B"

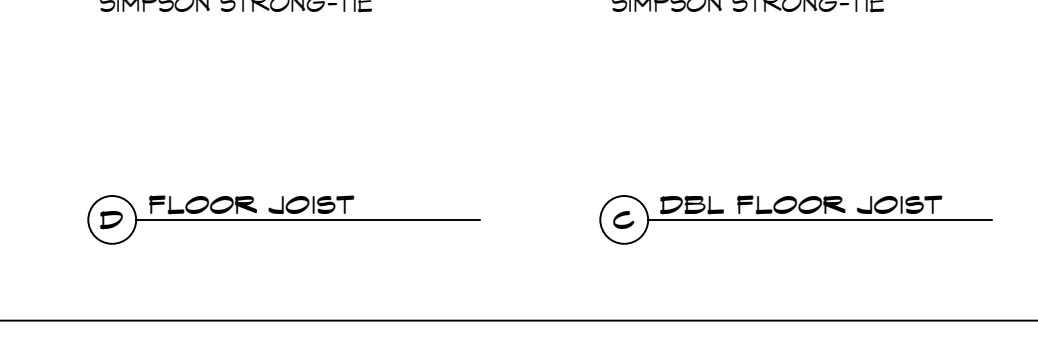

TABLE S601.1 - WALL SHEATHING AND CLADDING REQUIREMENT - WIND LOAD EXP "B"

METAL ROOF APPLICATION & FASTENING NOTES

1. INSTALL 26 GAUGE METAL ROOF PER MANUFACTURER'S RECOMMENDATIONS FOR 140 MPH WIND SPEED.

GENERAL UPLIFT CONNECTION NOTES

ROOF ASSEMBLY TO WALL ASSEMBLY: UPLIFT CONNECTIONS SHALL BE FROM RAFTER OR TRUSS TO WALL STUD. WHEN RAFTERS OR TRUSSES ARE NOT LOCATED DIRECTLY ABOVE STUDS, RAFTERS SHALL BE ATTACHED TO THE WALL PLATE AND THE WALL TOP PLATE SHALL BE ATTACHED TO THE WALL STUD WITH UPLIFT CONNECTIONS. UPLIFT CONNECTIONS SHALL BE IN ACCORDANCE WITH TABLE S601.10.

WALL ASSEMBLY TO WALL ASSEMBLY: STORY TO STORY UPLIFT CONNECTIONS FROM UPPER STORY WALL STUD TO LOWER STORY WALL STUD. WHEN UPPER STORY WALL STUDS ARE NOT LOCATED DIRECTLY ABOVE LOWER WALL STUDS, THE STUDS SHALL BE ATTACHED TO A COMMON MEMBER IN THE WALL STUD WITH UPLIFT CONNECTIONS. UPLIFT CONNECTIONS SHALL BE IN ACCORDANCE WITH TABLE S601.11.

FIRST FLOOR WALL STUDS TO FOUNDATION: FIRST FLOOR WALL STUDS SHALL BE CONNECTED TO THE FOUNDATION, SILL PLATE, OR BOTTOM PLATE. A MINIMUM OF A 1-1/4" X 20" GA. ASTM A653 GRADE 33 STEEL STRAP SHALL BE NAIL TO THE WALL STUD. WALL STUDS HAVE A MINIMUM EMBEDMENT OF 1 INCHES IN CONCRETE FOUNDATIONS AND SLABS-ON-GRADE, 15 INCHES IN MASONRY BLOCK FOUNDATIONS, OR BE LAPPED UNDER THE BOTTOM PLATE, 3 INCH SQUARE WASHERS SHALL BE USED ON THE ANCHOR BOLTS AND ANCHOR BOLT SPACINGS SHALL NOT EXCEED THE REQUIREMENTS. STEEL STRAPS EMBEDDED IN OR IN CONTACT WITH SLAB-ON-GRADE OR MASONRY BLOCK FOUNDATIONS SHALL BE HOT-DIPPED GALV. AFTER FABRICATION, OR MANUF. FROM G105 OR 2450 GALV. STL. CONNECTIONS SHALL BE IN ACCORDANCE WITH TABLE S601.12.

TABLE S601.1 - ROOF SHEATHING ATTACHMENT REQUIREMENT - WIND LOAD EXP "B"

SHEATHING LOCATION	RAFTER / TRUSS SPACING	E F	
		MAX NAIL SPACING FOR 8d COMMON NAILS OR 10d BOX NAILS (INCHES OC)	
INTERIOR ZONE	12" OC	6	12
	16" OC	6	12
	24" OC	6	12
PERIMETER EDGE ZONE	12" OC	6	6
	24" OC	4	4

TABLE S601.1 - WALL SHEATHING AND CLADDING REQUIREMENT - WIND LOAD EXP "B"

SHEATHING LOCATION	RAFTER / TRUSS SPACING	E F	
		MAX NAIL SPACING FOR 8d COMMON NAILS OR 10d BOX NAILS (INCHES OC)	
INTERIOR ZONE	12" OC	6	12
	16" OC	6	12
	24" OC	6	6
PERIMETER EDGE ZONE	12" OC	6	12
	24" OC	6	6

TABLE S601.1 - WALL SHEATHING AND CLADDING REQUIREMENT - WIND LOAD EXP "B"

SHEATHING LOCATION	RAFTER / TRUSS SPACING	E F	
		MAX NAIL SPACING FOR 8d COMMON NAILS OR 10d BOX NAILS (INCHES OC)	
INTERIOR ZONE	12" OC	6	12
	16" OC	6	12
	24" OC	6	6
PERIMETER EDGE ZONE	12" OC	6	12
	24" OC	6	6

TABLE S601.1 - WALL SHEATHING AND CLADDING REQUIREMENT - WIND LOAD EXP "B"

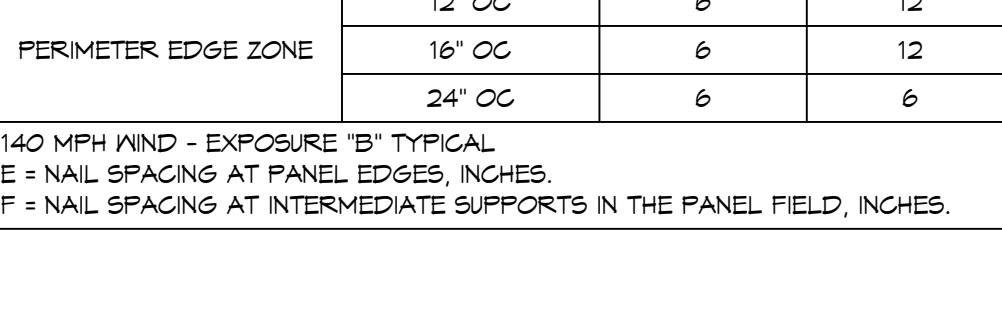

TABLE S601.1 - WALL SHEATHING AND CLADDING REQUIREMENT - WIND LOAD EXP "B"

SHEATHING LOCATION	RAFTER / TRUSS SPACING	E F	
		MAX NAIL SPACING FOR 8d COMMON NAILS OR 10d BOX NAILS (INCHES OC)	
INTERIOR ZONE	12" OC	6	12
	16" OC	6	12
	24" OC	6	6
PERIMETER EDGE ZONE	12" OC	6	12
	24" OC	6	6

TABLE S601.1 - WALL SHEATHING AND CLADDING REQUIREMENT - WIND LOAD EXP "B"

