

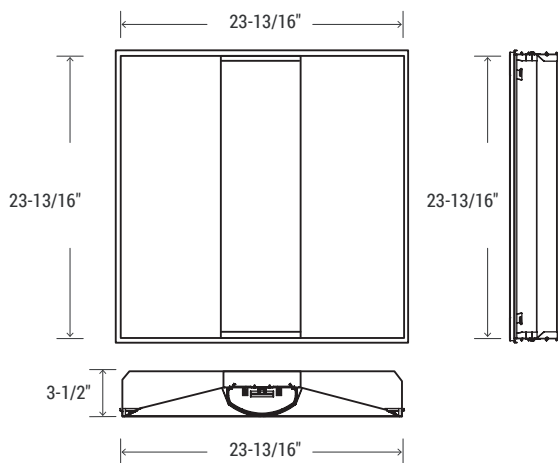

**EASY 3 COLORS  
SELECTOR**  
3500K • 4000K • 5000K



2000/3000/4000		
NOMINAL LUMENS	DELIVERED LUMENS	WATTAGE
4000	4569	32W
3000	3178	21W
2000	2589	17W

Based on 4000K, 85+ CRI. Actual wattage may vary +/- 5%

5000/6000/7000		
NOMINAL LUMENS	DELIVERED LUMENS	WATTAGE
7000	7036	55W
6000	6117	46W
5000	5142	37W

Based on 4000K, 85+ CRI. Actual wattage may vary +/- 5%

**FEATURES**

A combination of stylish design and shallow profile, coupled with innovative LED technology to deliver soft, glare-free illumination, resulting in improved visual comfort and uniform appearance. The enhancement of the volumetric effect provides increased brightness, with an aesthetically pleasing appearance and contemporary design. The energy saving features and optical performance create the ideal choice for educational, medical, office and retail spaces.

LUMENS	2000L/3000L/4000L 5000L/6000L/7000L
CCT & DYNAMIC PLATFORMS	35K/40K/50K
CRI	85+
COLOR QUALITY	3 Step MacAdam Ellipse
SIZE	2'x2', 2'x4'
MOUNTING	Recessed
DIMMING & CONTROL	0-10V Flicker Free 10% Dimming Standard (DIM10)
EMERGENCY	10W - Up to 1000L output (Bodine BSL310) 20W - Up to 2000L output (Bodine BSL20)
LIFETIME	L70 at 50,000 Hours
PHOTOMETRIC TESTS	In Accordance with IES LM79-08, LM80 and TM-30, TM-21



**MAINTENANCE**

The center acrylic diffuser can be removed, allowing easy access to LED boards and driver compartment, locking into place for secure closure of the luminaire. LED engines and drivers are removable and upgradable even after luminaire installation. Luminaire can be regularly and safely wiped down to ensure optimal performance.

**OPTICAL SYSTEM**

The LED light engine is secured to the body of the luminaire, with the body acting as a heat sink. A proprietary design of the lens results in zero pixilation, regardless of the viewing angle, with LEDs placed to promote a uniform appearance. The result is even illumination across the space, from luminaire to luminaire.

**CONSTRUCTION**

Body is constructed of heavy-duty 20-gauge cold rolled steel, post-painted and engineered for maximum strength and extended life. All corners interlock to prevent aesthetic damage to the luminaire, with sides and corners uniformly turned in and hemmed to remove sharp edges for safe handling and easy installation. Luminaire is supplied with multiple wiring entrances for easy daisy chain of luminaires, to add power packs, whips, or other accessories in the field, or for continuous row mounting.

**FINISH**

Post-painted with a 93% reflective white coat to improve luminaire efficacy, with all body components seamlessly interlocked for added structural strength.

**MOUNTING**

Luminaires accommodate lay-in ceilings, Slot T, and T-bar suspension systems for 5/8" and 3/8" ceiling thicknesses. Four corner tie points are standard for safety wire support when required, with built-in earthquake clips, standard. Luminaires may be available with flange kits, surface mounted kits, and other options.

**OPTIONS**

Luminaires can be shipped pre-installed with whips, modular wiring systems, daylight harvesting controls, occupancy sensors, and/or power packs for individual or room control applications.

**DRIVER ELECTRICAL INFORMATION**

Powered by high-quality constant-current power LED drivers which are rated for 50 to 60Hz at 120/277V input.

**DIMMING & DRIVER INFORMATION**

**DIM10** - Flicker Free 10% Dimming Standard (DIM10) 0-10V dimming on either MVOLT 120, 277V.

**WARRANTY**

Five-year warranty for parts and components. (Labor not included)

**LISTINGS**

c-UL-us - Listed for Feed Through Wiring.  
Listed for DLC, California Title 24 compliant.

Example: **22-OEVHP-LED-2000L/3000L/4000L-DIM10-MVOLT-35K/40K/50K-85**

22	OEVHP	LED							
FIXTURE SIZE	SERIES	TYPE	LUMENS	DIMMING	VOLTAGE	CCT	CRI	EMERGENCY	
22 - 2' X2'	OEVHP - LED Shallow Volumetric Troffer	LED	2000L/3000L/4000L 5000L/6000L/7000L	DIM10 - 0-10V Dimming	MVOLT	35K/40K/50K	85	0-EMG-LED-10W 0-EMG-LED-20W	
			2000L/3000L/4000L	DIM10 - 0-10V Dimming		30K*			<b>OTHER OPTIONS</b>
						*Only for 2000/3000/4000L			<b>22FK</b> - 2'x2' Flange Kit <b>22-OEVHP-LED-SMK</b> - 2'x2' Surface Mount Kit <b>FBF</b> - Internal Fast Blow Fuse <b>SBF</b> - Internal Slow Blow Fuse <b>RIS</b> - Radio Interference Suppressor <b>USA</b> - Made in America Compliance

**22-OEVHP-LED-2000L-3000L-4000L-DIM10-MVOLT-35K-40K-50K-85(2000L)**

**TEST NO. : EL02102041**

INPUT WATTS: **17.3** LUMENS: **2589** CRI: **85** EFFICACY: **150** CCT: **40K** SPACING CRITERIA: **1.42**

**Candle Power Distribution (Candelas)**

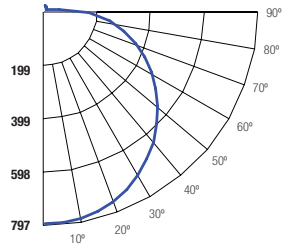

**Zonal Lumens Summary**

Zone	Lumens	%Lamp	%Fixt
0-20	291.83	11.30	11.30
0-30	621.81	24.00	24.00
0-40	1024.88	39.60	39.60
0-60	1861.27	72.00	71.90
0-80	2445.68	94.60	94.50
0-90	2552.13	98.70	98.60

**Luminance (Average candela/M<sup>2</sup>)**

Angle in Degrees	Average		
	0°	45°	90°
45	2300	2147	1965
55	2429	2178	1895
65	2681	2266	1801
75	3253	2506	1632
85	5138	3563	1349

**Lumens Per Zone**

Zone	Lumens
0-10	75.40
10-20	216.43
20-30	329.99
30-40	403.07
40-50	428.97
50-60	407.41
60-70	342.52
70-80	241.90
80-90	106.45

**Candela Tabulation**

Q	0
0	796.851
5	797.380
15	778.340
25	738.720
35	679.820
45	604.940
55	518.260
65	421.490
75	313.190
85	166.570
90	53.030

**Coefficients of Utilization - Zonal Cavity Method**

Effective Floor Cavity Reflectance 0.20

RC	80%				70%				50%				30%			10%			0%		
	RW	70%	50%	30%	10%	70%	50%	30%	10%	50%	30%	10%	50%	30%	10%	50%	30%	10%	0%		
0	119	119	119	119	116	116	116	116	110	110	110	105	105	105	101	101	101	101	99		
1	107	102	97	92	104	99	95	91	95	91	88	90	87	85	86	84	82	80	80		
2	97	88	80	74	94	86	79	73	82	76	71	78	73	69	75	71	67	65	65		
3	88	76	68	61	85	75	66	60	71	64	59	68	62	57	66	61	56	54	54		
4	80	67	58	51	78	66	57	50	63	56	50	61	54	49	58	53	48	46	46		
5	73	60	50	43	71	59	50	43	56	49	43	54	47	42	52	46	41	39	39		
6	68	54	44	38	66	53	44	37	51	43	37	49	42	37	47	41	36	34	34		
7	63	49	40	33	61	48	39	33	46	38	33	44	37	32	43	37	32	30	30		
8	58	44	36	29	57	44	35	29	42	34	29	41	34	29	39	33	28	27	27		
9	54	41	32	26	53	40	32	26	39	31	26	37	31	26	36	30	26	24	24		
10	51	37	29	24	50	37	29	24	36	29	24	35	28	23	34	28	23	21	21		

RC - Ceiling Cavity Reflectance RW - Wall Reflectance

**22-OEVHP-LED-2000L-3000L-4000L-DIM10-MVOLT-35K-40K-50K-85(3000L)**

**TEST NO. : EL02102061**

INPUT WATTS: **21.5** LUMENS: **3178** CRI: **85** EFFICACY: **148** CCT: **40K** SPACING CRITERIA: **1.42**

**Candle Power Distribution (Candelas)**

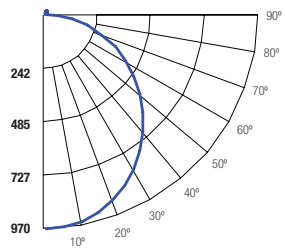

**Zonal Lumens Summary**

Zone	Lumens	%Lamp	%Fixt
0-20	355.25	11.20	11.20
0-30	759.03	23.90	23.90
0-40	1253.75	39.50	39.50
0-60	2280.66	71.80	71.80
0-80	3001.03	94.50	94.40
0-90	3132.7	98.70	98.60

**Luminance (Average candela/M<sup>2</sup>)**

Angle in Degrees	Average		
	0°	45°	90°
45	2395	2523	2686
55	2311	2530	2803
65	2229	2562	3035
75	2018	2762	3611
85	1669	3301	4642

**Lumens Per Zone**

Zone	Lumens
0-10	91.78
10-20	263.47
20-30	403.78
30-40	494.72
40-50	526.62
50-60	500.28
60-70	421.35
70-80	299.02
80-90	131.67

**Candela Tabulation**

Q	0
0	969.793
5	964.800
15	926.850
25	853.470
35	751.620
45	629.810
55	493.140
65	350.320
75	194.250
85	54.110
90	9.810

**Coefficients of Utilization - Zonal Cavity Method**

Effective Floor Cavity Reflectance 0.20

RC	80%				70%				50%				30%			10%			0%		
	RW	70%	50%	30%	10%	70%	50%	30%	10%	50%	30%	10%	50%	30%	10%	50%	30%	10%	0%		
0	119	119	119	119	116	116	116	116	110	110	110	105	105	105	101	101	101	101	99		
1	107	102	97	92	104	99	95	91	95	91	88	90	87	85	86	84	82	79	79		
2	97	88	80	74	94	86	79	73	82	76	71	78	73	69	75	71	67	65	65		
3	88	76	67	60	85	75	66	60	71	64	59	68	62	57	66	60	56	54	54		
4	80	67	58	51	77	66	57	50	63	55	49	60	54	49	58	52	48	46	45		
5	73	60	50	43	71	59	50	43	56	48	42	54	47	42	52	46	41	39	39		
6	68	54	44	38	66	53	44	37	51	43	37	49	42	37	47	41	36	34	34		
7	63	49	39	33	61	48	39	33	46	38	33	44	37	32	43	37	32	30	30		
8	58	44	35	29	57	44	35	29	42	34	29	41	34	29	39	33	28	26	26		
9	54	41	32	26	53	40	32	26	39	31	26	37	31	26	36	30	26	24	24		
10	51	37	29	24	50	37	29	24	36	29	24	35	28	23	34	28	23	21	21		

RC - Ceiling Cavity Reflectance RW - Wall Reflectance

**22-OEVHP-LED-2000L-3000L-4000L-DIM10-MVOLT-35K-40K-50K-85(4000L)**

**TEST NO. : EL02102047**

INPUT WATTS: **32** LUMENS: **4569** CRI: **85** EFFICACY: **143** CCT: **40K** SPACING CRITERIA: **1.42**

**Candle Power Distribution (Candelas)**

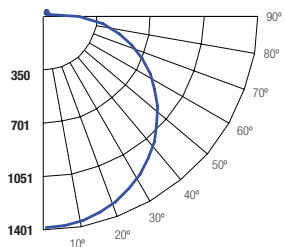

**Zonal Lumens Summary**

Zone	Lumens	%Lamp	%Fixt
0-20	512.62	11.20	11.20
0-30	1092.23	23.90	23.90
0-40	1800.28	39.40	39.40
0-60	3275.59	71.80	71.70
0-80	4312.83	94.50	94.40
0-90	4503.17	98.70	98.60

**Luminance (Average candela/M<sup>2</sup>)**

Angle in Degrees	Average		
	0°	45°	90°
45	3460	3642	3875
55	3337	3653	4046
65	3176	3719	4384
75	2918	3980	5145
85	2417	4770	6691

**Lumens Per Zone**

Zone	Lumens
0-10	132.44
10-20	380.17
20-30	579.62
30-40	708.05
40-50	754.47
50-60	720.84
60-70	607.26
70-80	429.98
80-90	190.34

**Candela Tabulation**

Q	0
0	1399.479
5	1393.780
15	1338.240
25	1232.870
35	1086.110
45	910.080
55	712.030
65	499.320
75	280.890
85	78.370
90	14.220

**Coefficients of Utilization - Zonal Cavity Method**

Effective Floor Cavity Reflectance 0.20

RC	80%				70%				50%				30%			10%			0%		
	RW	70%	50%	30%	10%	70%	50%	30%	10%	50%	30%	10%	50%	30%	10%	50%	30%	10%	0%		
0	119	119	119	119	116	116	116	116	110	110	110	105	105	105	101	101	101	101	99		
1	107	102	97	92	104	99	95	91	95	91	88	90	87	85	86	84	82	79	79		
2	97	88	80	74	94	86	79	73	82	76	71	78	73	69	75	71	67	65	65		
3	88	76	67	60	85	75	66	60	71	64	59	68	62	57	66	60	56	54	54		
4	80	67	58	51	77	66	57	50	63	55	49	60	54	49	58	52	48	46	45		
5	73	60	50	43	71	59	50	43	56	48	42	54	47	42	52	46	41	39	39		
6	68	54	44	38	66	53	44	37	51	43	37	49	42	37	47	41	36	34	34		
7	63	49	39	33	61	48	39	33	46	38	33	44	37	32	43	37	32	30	30		
8	58	44	35	29	57	44	35	29	42	34	29	41	34	29	39	33	28	26	26		
9	54	41	32	26	53	40	32	26	39	31	26	37	31	26	36	30	26	24	24		
10	51	37	29	24	50	37	29	24	36	29	24	35	28	23	34	28	23	21	21		

RC - Ceiling Cavity Reflectance RW - Wall Reflectance

**22-OEVHP-LED-5000L-6000L-7000L-DIM10-MVOLT-35K-40K-50K-85(5000L)**

TEST NO.: **EL12292035**

INPUT WATTS: **37.8**

LUMENS: **5142**

CRI: **N/A**

EFFICACY: **136**

CCT: **3500K**

SPACING CRITERIA: **1.40**

**Candle Power Distribution (Candelas)**

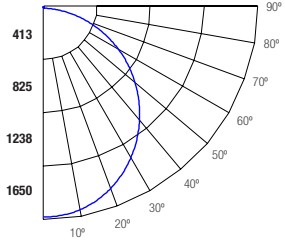

**Zonal Lumens Summary**

Zone	Lumens	%Lamp	%Fixt
0-20	597.02	11.60	11.60
0-30	1270.11	24.70	24.70
0-40	2088.34	40.60	40.60
0-60	3769.05	73.30	73.30
0-80	4913.43	95.60	95.60
0-90	5091.46	99.00	99.00

**Luminance (Average candela/M<sup>2</sup>)**

Angle in Degrees	Average 0°	Average 45°	Average 90°
45	4297	4162	4042
55	4388	4123	3891
65	4607	4138	3676
75	5056	4264	3345
85	4068	4288	2747

**Lumens Per Zone**

Zone	Lumens
0-10	154.40
10-20	442.63
20-30	673.09
30-40	818.23
40-50	864.70
50-60	816.02
60-70	679.16
70-80	465.22
80-90	178.03

**Candela Tabulation**

0	
0.0	1632.163
5.0	1621.260
15.0	1556.550
25.0	1449.540
35.0	1304.690
45.0	1130.170
55.0	936.210
65.0	724.180
75.0	486.740
85.0	131.890
90.0	4.440

**Coefficients of Utilization - Zonal Cavity Method**

Effective Floor Cavity Reflectance 0.20

ROOM CAVITY RATIO	RC RW	80%				70%				50%			30%			10%			0%
		70%	50%	30%	10%	70%	50%	30%	10%	50%	30%	10%	50%	30%	10%	50%	30%	10%	
0	119	119	119	119	116	116	116	116	111	111	111	106	106	106	101	101	101	99	
1	107	102	97	93	104	100	95	91	95	92	88	91	88	85	87	85	83	81	
2	97	88	81	75	94	86	79	74	82	77	72	79	74	70	76	72	68	66	
3	88	77	68	61	85	75	67	61	72	65	59	69	63	58	66	61	57	55	
4	80	68	59	52	78	66	58	51	64	56	50	61	55	49	59	53	49	46	
5	74	60	51	44	72	59	50	44	57	49	43	55	48	43	53	47	42	40	
6	68	54	45	38	66	53	44	38	51	43	38	49	43	37	48	42	37	35	
7	63	49	40	34	61	48	40	34	47	39	33	45	38	33	44	37	33	31	
8	59	45	36	30	57	44	36	30	43	35	30	41	34	29	40	34	29	27	
9	55	41	33	27	53	40	32	27	39	32	27	38	31	26	37	31	26	24	
10	51	38	30	24	50	37	30	24	36	29	24	35	29	24	34	28	24	22	

RC - Ceiling Cavity Reflectance RW - Wall Reflectance

**22-OEVHP-LED-5000L-6000L-7000L-DIM10-MVOLT-35K-40K-50K-85(6000L)**

TEST NO.: **EL12292036**

INPUT WATTS: **46.4**

LUMENS: **6117**

CRI: **N/A**

EFFICACY: **132**

CCT: **3500K**

SPACING CRITERIA: **1.40**

**Candle Power Distribution (Candelas)**

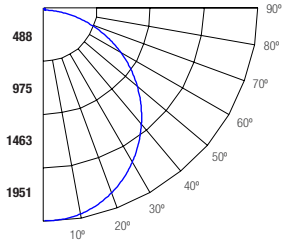

**Zonal Lumens Summary**

Zone	Lumens	%Lamp	%Fixt
0-20	710.85	11.60	11.60
0-30	1512.26	24.70	24.70
0-40	2486.53	40.60	40.60
0-60	4484.58	73.30	73.30
0-80	5844.96	95.60	95.60
0-90	6057.18	99.00	99.00

**Luminance (Average candela/M<sup>2</sup>)**

Angle in Degrees	Average 0°	Average 45°	Average 90°
45	5102	4943	4813
55	5209	4899	4633
65	5467	4918	4380
75	5998	5064	3952
85	4831	5035	3252

**Lumens Per Zone**

Zone	Lumens
0-10	183.82
10-20	527.02
20-30	801.41
30-40	974.27
40-50	1029.59
50-60	968.46
60-70	806.73
70-80	553.64
80-90	212.23

**Candela Tabulation**

0	
0.0	1942.745
5.0	1925.510
15.0	1848.780
25.0	1721.280
35.0	1549.250
45.0	1341.830
55.0	1111.250
65.0	859.360
75.0	577.470
85.0	156.600
90.0	5.280

**Coefficients of Utilization - Zonal Cavity Method**

Effective Floor Cavity Reflectance 0.20

ROOM CAVITY RATIO	RC RW	80%				70%				50%			30%			10%			0%
		70%	50%	30%	10%	70%	50%	30%	10%	50%	30%	10%	50%	30%	10%	50%	30%	10%	
0	119	119	119	119	116	116	116	116	111	111	111	106	106	106	101	101	101	99	
1	107	102	97	93	104	100	95	91	95	92	88	91	88	85	87	85	83	81	
2	97	88	81	75	94	86	79	74	82	77	72	79	74	70	76	72	68	66	
3	88	77	68	61	85	75	67	61	72	65	59	69	63	58	66	61	57	55	
4	80	68	59	52	78	66	58	51	64	56	50	61	55	49	59	53	49	46	
5	74	60	51	44	72	59	50	44	57	49	43	55	48	43	53	47	42	40	
6	68	54	45	38	66	53	44	38	51	43	38	49	43	37	48	42	37	35	
7	63	49	40	34	61	48	40	34	47	39	33	45	38	33	44	37	33	31	
8	59	45	36	30	57	44	36	30	43	35	30	41	34	29	40	34	29	27	
9	55	41	33	27	53	40	32	27	39	32	27	38	31	26	37	31	26	24	
10	51	38	30	24	50	37	30	24	36	29	24	35	29	24	34	28	24	22	

RC - Ceiling Cavity Reflectance RW - Wall Reflectance

**22-OEVHP-LED-5000L-6000L-7000L-DIM10-MVOLT-35K-40K-50K-85(7000L)**

TEST NO.: **EL12292037**

INPUT WATTS: **55.6**

LUMENS: **7036**

CRI: **N/A**

EFFICACY: **127**

CCT: **3500K**

SPACING CRITERIA: **1.40**

**Candle Power Distribution (Candelas)**

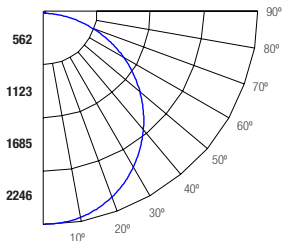

**Zonal Lumens Summary**

Zone	Lumens	%Lamp	%Fixt
0-20	818.14	11.60	11.60
0-30	1740.48	24.70	24.70
0-40	2861.66	40.70	40.70
0-60	5160.44	73.30	73.30
0-80	6722.41	95.50	95.50
0-90	6966.72	99.00	99.00

**Luminance (Average candela/M<sup>2</sup>)**

Angle in Degrees	Average 0°	Average 45°	Average 90°
45	5871	5692	5538
55	5992	5642	5331
65	6291	5656	5038
75	6903	5815	4528
85	5565	5723	3745

**Lumens Per Zone**

Zone	Lumens
0-10	211.57
10-20	606.57
20-30	922.35
30-40	1121.17
40-50	1184.79
50-60	1113.99
60-70	925.67
70-80	636.30
80-90	244.31

**Candela Tabulation**

0	
0.0	2235.876
5.0	2215.970
15.0	2127.770
25.0	1980.860
35.0	1783.300
45.0	1544.060
55.0	1278.350
65.0	988.920
75.0	664.520
85.0	180.420
90.0	6.080

**Coefficients of Utilization - Zonal Cavity Method**

Effective Floor Cavity Reflectance 0.20

ROOM CAVITY RATIO	RC RW	80%				70%				50%			30%			10%			0%
		70%	50%	30%	10%	70%	50%	30%	10%	50%	30%	10%	50%	30%	10%	50%	30%	10%	
0	119	119	119	119	116	116	116	116	111	111	111	106	106	106	101	101	101	99	
1	107	102	97	93	104	100	95	91	95	92	88	91	88	85	87	85	83	81	
2	97	88	81	75	94	86	79	74	82	77	72	79	74	70	76	72	68	66	
3	88	77	68	61	85	75	67	61	72	65	59	69	63	58	66	61	57	55	
4	80	68	59	52	78	66	58	51	64	56	50	61	55	49	59	53	49	46	
5	74	60	51	44	72	59	50	44	57	49	43	55	48	43	53	47	42	40	
6	68	54	45	38	66	53	45	38	51	43	38	50	43	37	48	42	37	35	
7	63	49	40	34	61	48	40	34	47	39	33	45	38	33	44	37	33	31	
8	59	45	36	30	57	44	36	30	43	35	30	41	34	29	40	34	29	27	
9	55	41	33	27	53	40	32	27	39	32	27								