

**FAUCET
K-T195**

ALSO K-T197, K-T199, K-307-K

ADA

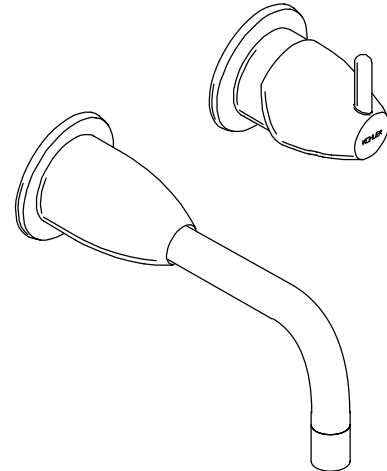

FEATURES

- Brass construction
- Available with 6", 9", or 12" spout
- 2.2 gallons per minute
- Lever handle

CODES/STANDARDS APPLICABLE

Specified model meets or exceeds the following:

- ASME/ANSI A112.18.1M
- CSA B125
- Energy Policy Act of 1992
- IAPMO/UPC
- NSF 61

COLORS/FINISHES

- CP Polished Chrome
- PB Polished Brass
- Other Refer to Faucets Price Book for additional finishes

SPECIFIED MODEL:

Model	Description			
K-T195	With 6" Spout	<input type="checkbox"/> CP	<input type="checkbox"/> PB	<input type="checkbox"/> Other
K-T197	With 9" Spout	<input type="checkbox"/> CP	<input type="checkbox"/> PB	<input type="checkbox"/> Other
K-T199	With 12" Spout	<input type="checkbox"/> CP	<input type="checkbox"/> PB	<input type="checkbox"/> Other

Required Accessory		
K-307-K	Wall-Mount Valve	<input type="checkbox"/> NA

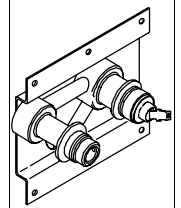





Optional Accessories on Page 2.

PRODUCT SPECIFICATION:

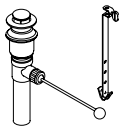
Single-control wall-mount faucet shall be of brass construction. Product shall include lever handle. Optional feature shall be 6", 9", or 12" spout. Trim shall be Kohler Model K-T_____ - _____ with K-307-K-NA valve.

FALLING WATER

Optional Accessories					
K-7702	Pop-Up Lavatory Drain	<input type="checkbox"/> CP	<input type="checkbox"/> PB		
K-7710	Lavatory Drain		<input type="checkbox"/> CP		
K-7715	Lavatory Drain			<input type="checkbox"/> CP	<input type="checkbox"/> PB
K-8801	Duostrainer Sink Strainer				<input type="checkbox"/> CP <input type="checkbox"/> PB <input type="checkbox"/> Other_____

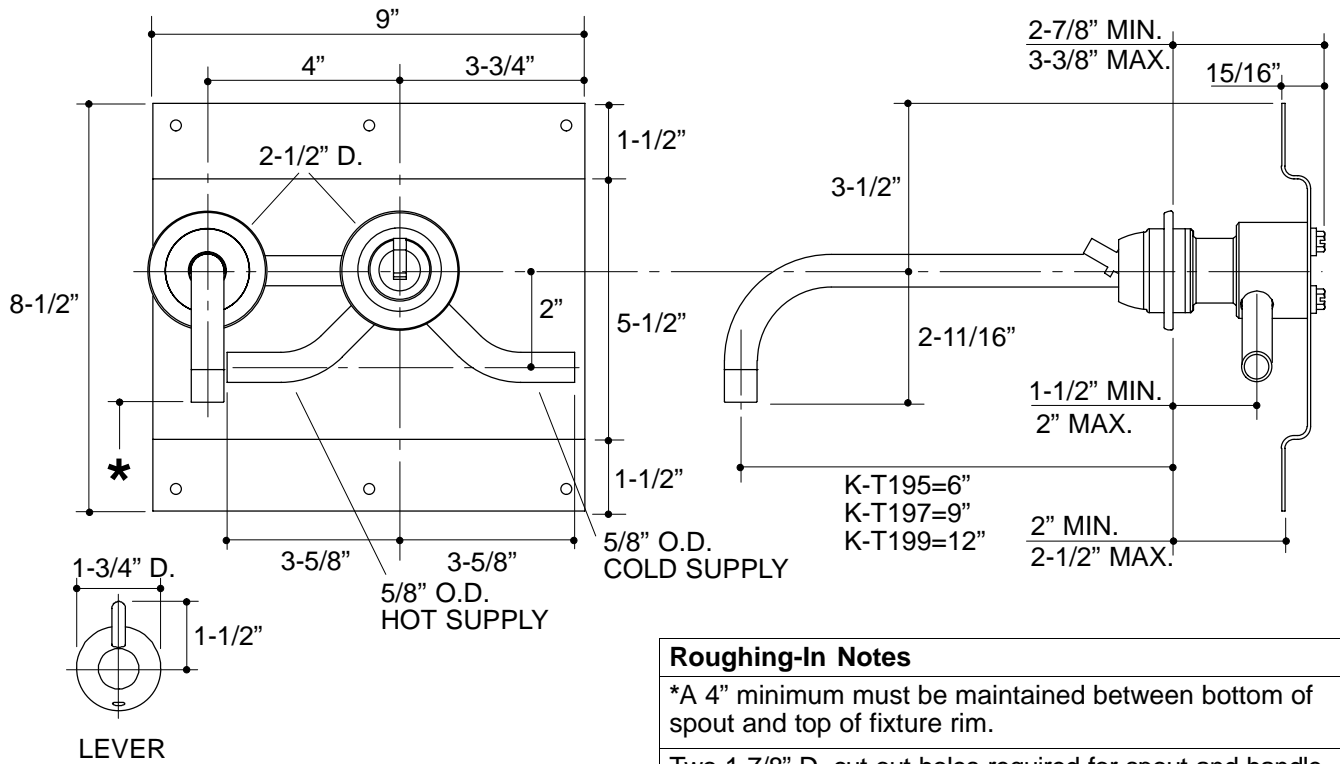

Roughing-In Notes

*A 4" minimum must be maintained between bottom of spout and top of fixture rim.

Two 1-7/8" D. cut-out holes required for spout and handle.

PRODUCT DIAGRAM