

Ordering Information

Applicable product:		
4" centers lavatory	K-2925-4	shown
8" centers lavatory	K-2925-8	not shown
Single-hole lavatory	K-2925-1	not shown
Accessories/hardware		
P-Trap	K-8998	optional

Product Information

ADA compliant.			
Fixture*:		basin area	water depth
Lavatory		17" x 13"	4-5/8"
Outlet	1-11/16" D.		
* Approximate measurements for comparison only.			
Holes	K-2925-4	K-2925-8	K-2925-1
Spout	1-1/8" D.	1-1/8" D.	1-3/8" D.
Faucet	1-3/16" D.	1-5/16" D.	
Included Components:			
Overflow ferrule			44071
Cutout template			101079

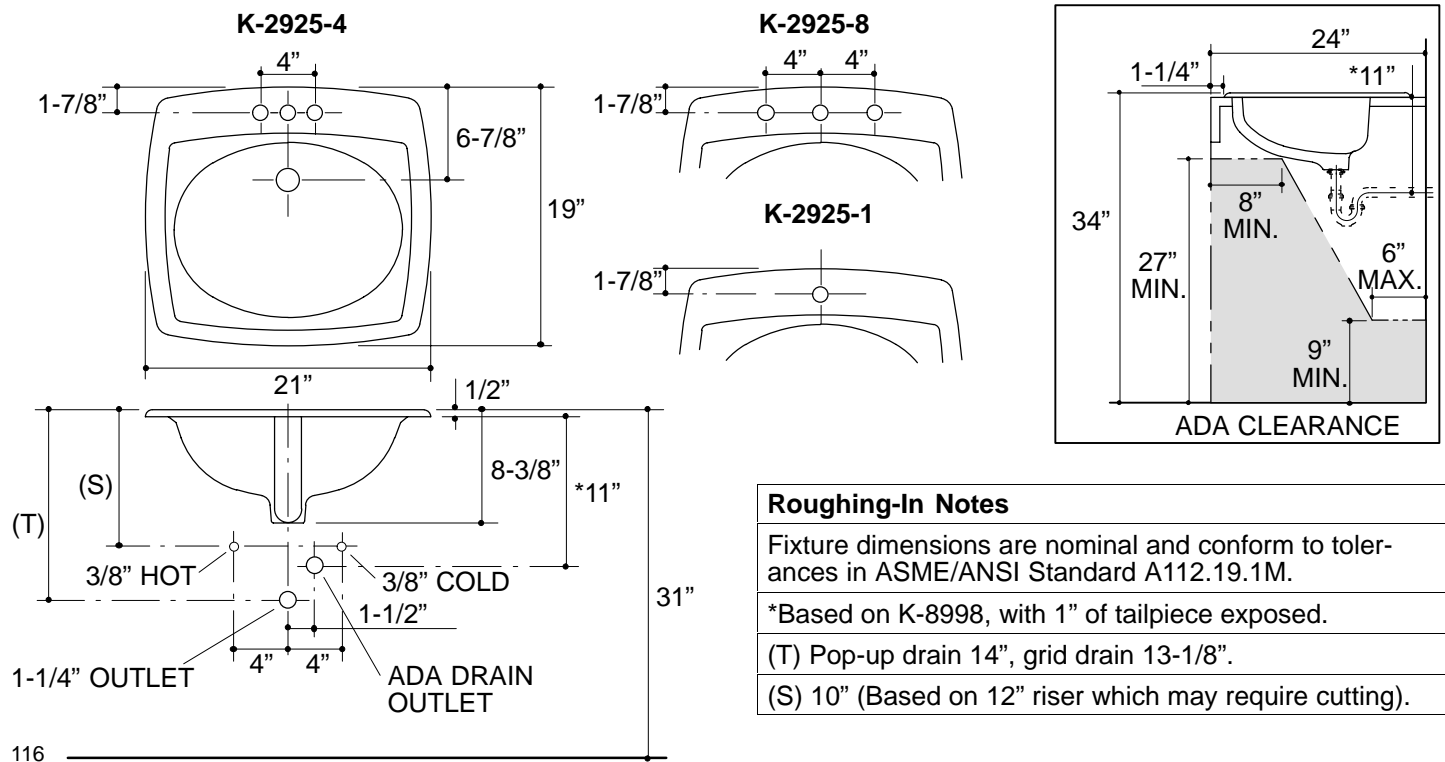

Roughing-In Notes
Fixture dimensions are nominal and conform to tolerances in ASME/ANSI Standard A112.19.1M.
*Based on K-8998, with 1" of tailpiece exposed.
(T) Pop-up drain 14", grid drain 13-1/8".
(S) 10" (Based on 12" riser which may require cutting).