

Ordering Information

Applicable product:		
Four-hole sink	K-5932-4	shown
Accessories/hardware:		
Bottom basin rack	K-6001	optional
Cutting board	K-6515	optional
Wire rinse basket	K-6521	optional

Product Information

Fixture*:		basin area	water depth
Sink, small		305 x 432mm	197mm
Sink, large		406 x 483mm	248mm
Outlet	Ø92mm		
Faucet holes	Ø35mm		
* Approximate measurements for comparison only.			

Installation Notes

Refer to installation instructions included with fixture before beginning installation.

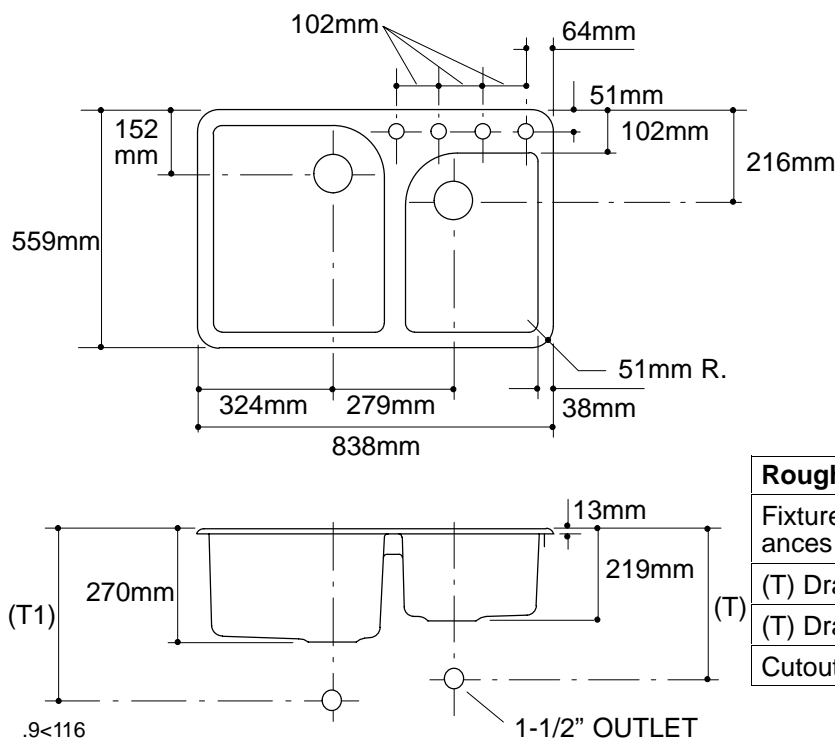

Roughing-In Notes

Fixture dimensions are nominal and conform to tolerances in ASME/ANSI Standard A112.19.1M.

(T) Drain typically 356mm.

(T) Drain typically 406mm.

Cutout 806 x 527mm with 25mm radius corners.