

**BIDET FAUCET  
K-142**

**FEATURES**

- Brass construction
- Flexible connections
- Brass valve bodies
- Quarter-turn washerless ceramic disc valves
- Pop-up drain with lift rod and tailpiece
- Variety of handle style options
- Vertical spray
- Fixture-mount transfer valve/vacuum breaker

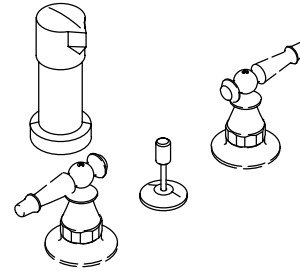

**CODES/STANDARDS APPLICABLE**

Specified model meets or exceeds the following:



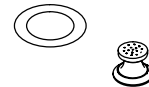



- ASME/ANSI A112.18.1M
- CSA B125
- IAPMO/UPC
- Listed in the State of Michigan



**COLORS/FINISHES**

- CP Polished Chrome
- PB Polished Brass
- Other Refer to Faucets Price Book for additional finishes

**SPECIFIED MODEL:**

<b>Antique Curio™ Models</b>				ADA
K-142-3D	With Antique Curio Six-Prong Handles	<input type="checkbox"/> CP	<input type="checkbox"/> PB	
K-142-4D	With Antique Curio Lever Handles			<input type="checkbox"/> CP <input type="checkbox"/> PB
<b>Required Accessory (For K-142-3D and K-142-4D)</b>				
K-17200	Trim Rings-Pair, Metal	<input type="checkbox"/> CP	<input type="checkbox"/> PB	
<b>Antique Models</b>				ADA
K-142-3	With Antique Six-Prong Handles	<input type="checkbox"/> CP	<input type="checkbox"/> PB	
K-142-4	With Antique Lever Handles		<input type="checkbox"/> CP <input type="checkbox"/> PB <input type="checkbox"/> Other_____	
K-142-9B	With Antique Oval Handles		<input type="checkbox"/> CP <input type="checkbox"/> PB <input type="checkbox"/> Other_____	
<b>Required Accessory (For K-142-9B Only)</b>				
K-253	Ceramic Oval Handle Insets and Skirts, Pair, Garland Texture	<input type="checkbox"/> Other_____		
K-258	Ceramic Oval Handle Insets and Skirts, Pair	<input type="checkbox"/> Other_____		

**PRODUCT SPECIFICATION:**

Two-handle fixture-mount bidet faucet shall be of brass construction. Faucet shall feature brass valve bodies. Faucet shall feature quarter-turn washerless ceramic disc valves, assuring positive handle stop positioning. Product shall include flexible connections, pop-up drain with lift rod and tailpiece, handles, vertical spray, and fixture-mount valve/vacuum breaker. Faucet shall be Kohler Model K-142-\_\_\_\_\_-\_\_\_\_ and trim, if required, shall be Kohler Model K-\_\_\_\_\_-\_\_\_\_\_.

# ANTIQUE™

Optional Accessories			
K-9637	Small Lever Inserts, Pair	<input type="checkbox"/> CP	<input type="checkbox"/> PB
K-9657	Small Lever Inserts, Pair	<input type="checkbox"/> Other _____	

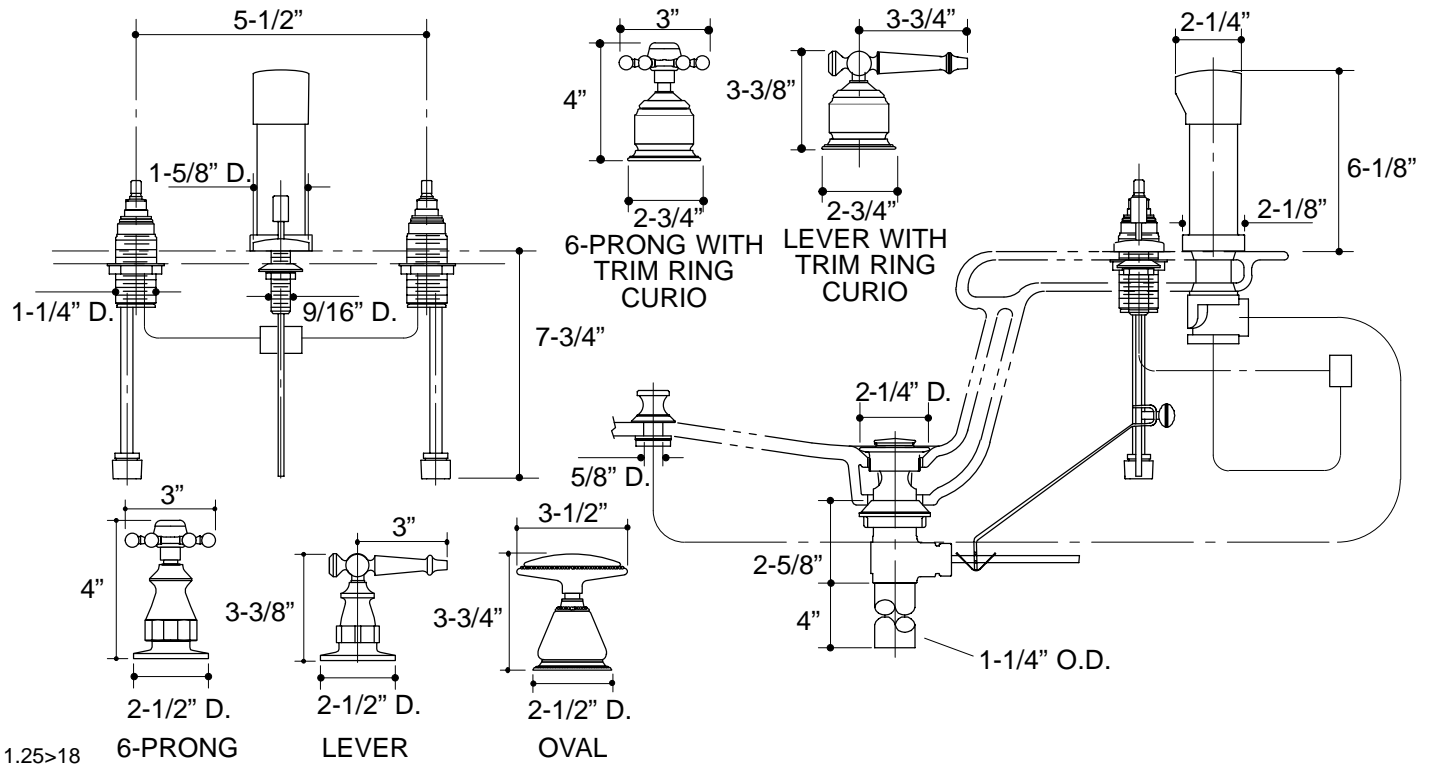

## PRODUCT DIAGRAM