

**ELECTRONIC FAUCET
K-13666
ALSO K-13664**

FEATURES

- Brass construction
- Single supply for single-hole mounting
- Electronic infrared sensor
- 5-3/16" gooseneck spout
- Vandal-resistant aerator
- 2.0 gallons per minute
- Five foot power cord
- Available with or without escutcheon plate

ADA

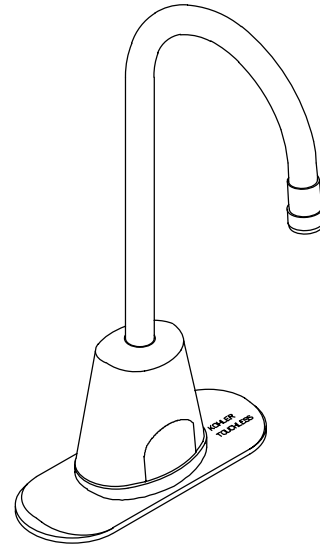

CODES/STANDARDS APPLICABLE

Specified model meets or exceeds the following:

- ASME/ANSI A112.18.1M
- CSA B125
- IAPMO/UPC
- Listed in the States of New York, Massachusetts, and Texas
- Listed in New York City, City of Chicago, and City of Los Angeles
- Underwriter's Laboratory (UL)

COLORS/FINISHES

- CP Polished Chrome

SPECIFIED MODEL:

Model	Description	
K-13664	Less Escutcheon Plate	<input type="checkbox"/> CP
K-13666	With Escutcheon Plate	<input type="checkbox"/> CP

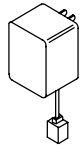

Required Accessory		
K-13667	Plug-In Power Supply	 <input type="checkbox"/> NA

Optional Accessories on Page 2.

PRODUCT SPECIFICATION:

Electronic faucet shall be of brass construction. Faucet shall feature an electronic infrared sensor. Product shall be less drain and requires a plug-in power supply. Product shall include single supply for single-hole mounting, 5-3/16" gooseneck spout, vandal-resistant aerator, and five foot power cord. Optional feature shall be with or without escutcheon plate. Faucet shall be Kohler Model K-_____ -CP and plug-in power supply shall be Kohler Model K-13667-NA.

TOUCHLESS™

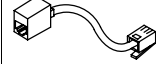
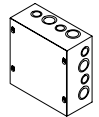
Optional Accessories					
K-7715	Lavatory Grid Drain	<input type="checkbox"/> CP <input type="checkbox"/> PB <input type="checkbox"/> Other_____			
K-13601	Thermostatic Mixing Valve		<input type="checkbox"/> NA		
K-13671	Five-Foot Extension Cord			<input type="checkbox"/> NA	
K-13684	Multiple Touchless Power Supply				<input type="checkbox"/> NA

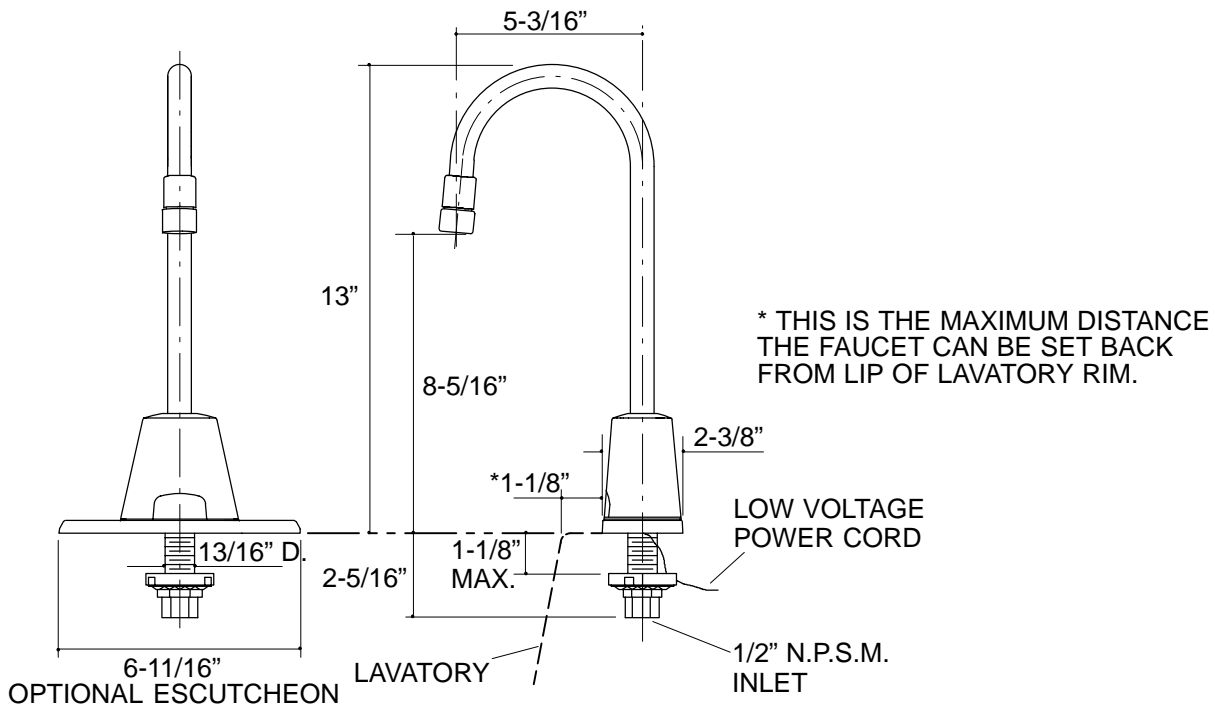

316

PRODUCT DIAGRAM