

**BATH AND SHOWER FAUCET TRIM  
K-T6900**

**ALSO K-T6902, K-T6904, K-304**

**FEATURES**

- Brass construction
- Available with square or lever handle

**CODES/STANDARDS APPLICABLE**

Specified model meets or exceeds the following:

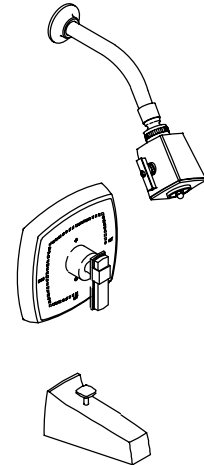

- ASME/ANSI A112.18.1M
- ASSE/ANSI 1016
- CSA B125 (K-T6900, K-T6902)
- IAPMO/UPC (K-T6900, K-T6902)



**COLORS/FINISHES**

- CP Polished Chrome
- PB Polished Brass
- Other Refer to Faucets Price Book for additional finishes

**SPECIFIED MODEL:** For complete faucet, both faucet trim and Rite-Temp valve must be specified.

Model	Description		 <small>ADA</small>
K-T6900-2	Bath and Shower Trim, Square Handle	<input type="checkbox"/> CP <input type="checkbox"/> PB <input type="checkbox"/> Other_____	
K-T6900-4	Bath and Shower Trim, Lever Handle		<input type="checkbox"/> CP <input type="checkbox"/> PB <input type="checkbox"/> Other_____
K-T6902-2	Shower Only Trim, Square Handle	<input type="checkbox"/> CP <input type="checkbox"/> PB <input type="checkbox"/> Other_____	
K-T6902-4	Shower Only Trim, Lever Handle		<input type="checkbox"/> CP <input type="checkbox"/> PB <input type="checkbox"/> Other_____
K-T6904-2	Valve Only Trim, Square Handle	<input type="checkbox"/> CP <input type="checkbox"/> PB <input type="checkbox"/> Other_____	
K-T6904-4	Valve Only Trim, Lever Handle		<input type="checkbox"/> CP <input type="checkbox"/> PB <input type="checkbox"/> Other_____

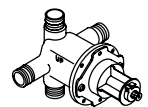
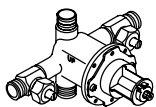
Required Accessory			
K-304-K	Rite-Temp Valve Without Stops	<input type="checkbox"/> NA	
K-304-KS	Rite-Temp Valve With Stops		<input type="checkbox"/> NA

**Optional Accessories on Page 2.**

**PRODUCT SPECIFICATION:**  
 Rite-Temp pressure-balancing single-control bath and shower faucet trim shall be of brass construction. Bath and shower trim shall include showerhead with arm and flange, faceplate with handle, and 4-7/8" diverter spout with N.P.T. connection. Shower only trim shall include showerhead with arm and flange, and faceplate with handle. Valve only trim shall include faceplate with handle. Faucet trim shall be K-T\_\_\_\_\_-\_\_\_\_\_-\_\_\_\_\_- and Rite-Temp valve shall be K-304-\_\_\_\_\_-NA.

Optional Accessories					
K-9917		Large Handle Stone Inset, Single			<input type="checkbox"/> Other_____
K-9923		Large Handle Metal Inset, Single	<input type="checkbox"/> CP	<input type="checkbox"/> PB	<input type="checkbox"/> Other_____
K-9926		Large Handle Ceramic Inset, Single			<input type="checkbox"/> Other_____
K-9932		Large Handle Champeve Inset, Single			<input type="checkbox"/> Other_____
K-9971		Small Lever Metal Inset, Single	<input type="checkbox"/> CP	<input type="checkbox"/> PB	<input type="checkbox"/> Other_____
K-9985		Small Lever Stone Inset, Single			<input type="checkbox"/> Other_____

## INSTALLATION NOTES

Avoid cross-flow conditions. Do not install shut-off device on either valve outlet.

Cap shower outlet if deck-mount spout, diverter, or handshower is connected to spout outlet.

Install straight pipe or tube drop of 7 to 18" with single elbow between valve and wall-mount spout.

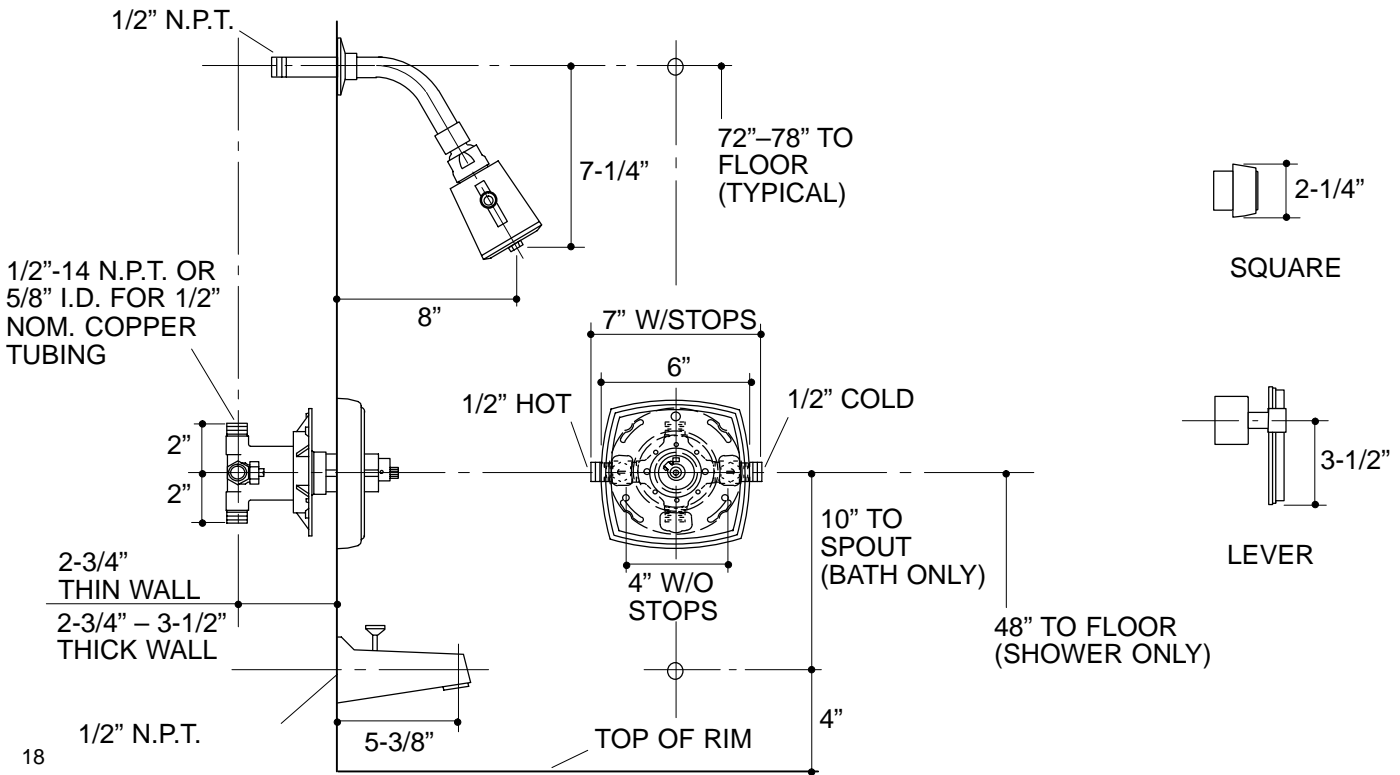

### PRODUCT DIAGRAM