

FEATURES



- Brass construction
- Modern to contemporary styling
- Completes Taboret faucet line

COLORS/FINISHES

- CP Polished Chrome
- PB Polished Brass
- Other Refer to Faucets Price Book for additional finishes

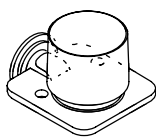
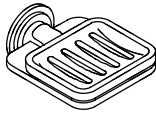
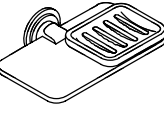
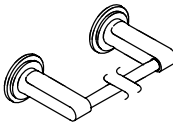
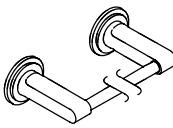
SPECIFIED MODEL:

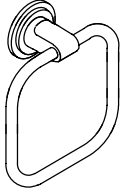
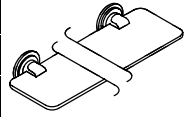
Model/Description	
K-8135 Taboret Single Tumbler and Toothbrush Holder; includes glass tumbler <input type="checkbox"/> CP <input type="checkbox"/> PB <input type="checkbox"/> Other_____	
K-8136 Taboret Soap Dish; includes removable glass dish <input type="checkbox"/> CP <input type="checkbox"/> PB <input type="checkbox"/> Other_____	
K-8137 Taboret Soap and Sponge Holder; includes removable glass dish <input type="checkbox"/> CP <input type="checkbox"/> PB <input type="checkbox"/> Other_____	
K-8138 Taboret 18" Towel Bar <input type="checkbox"/> CP <input type="checkbox"/> PB <input type="checkbox"/> Other_____	
K-8139 Taboret 24" Towel Bar <input type="checkbox"/> CP <input type="checkbox"/> PB <input type="checkbox"/> Other_____	

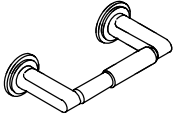
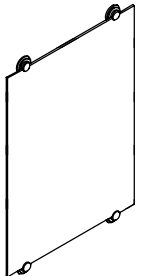
Model/Description	
K-8140 Taboret Towel Ring <input type="checkbox"/> CP <input type="checkbox"/> PB <input type="checkbox"/> Other_____	
K-8141 Taboret Glass Shelf <input type="checkbox"/> CP <input type="checkbox"/> PB <input type="checkbox"/> Other_____	
K-8142 Taboret Robe Hook <input type="checkbox"/> CP <input type="checkbox"/> PB <input type="checkbox"/> Other_____	
K-8143 Taboret Toilet Tissue Holder <input type="checkbox"/> CP <input type="checkbox"/> PB <input type="checkbox"/> Other_____	
K-8144 Taboret Mirror <input type="checkbox"/> CP <input type="checkbox"/> PB <input type="checkbox"/> Other_____	

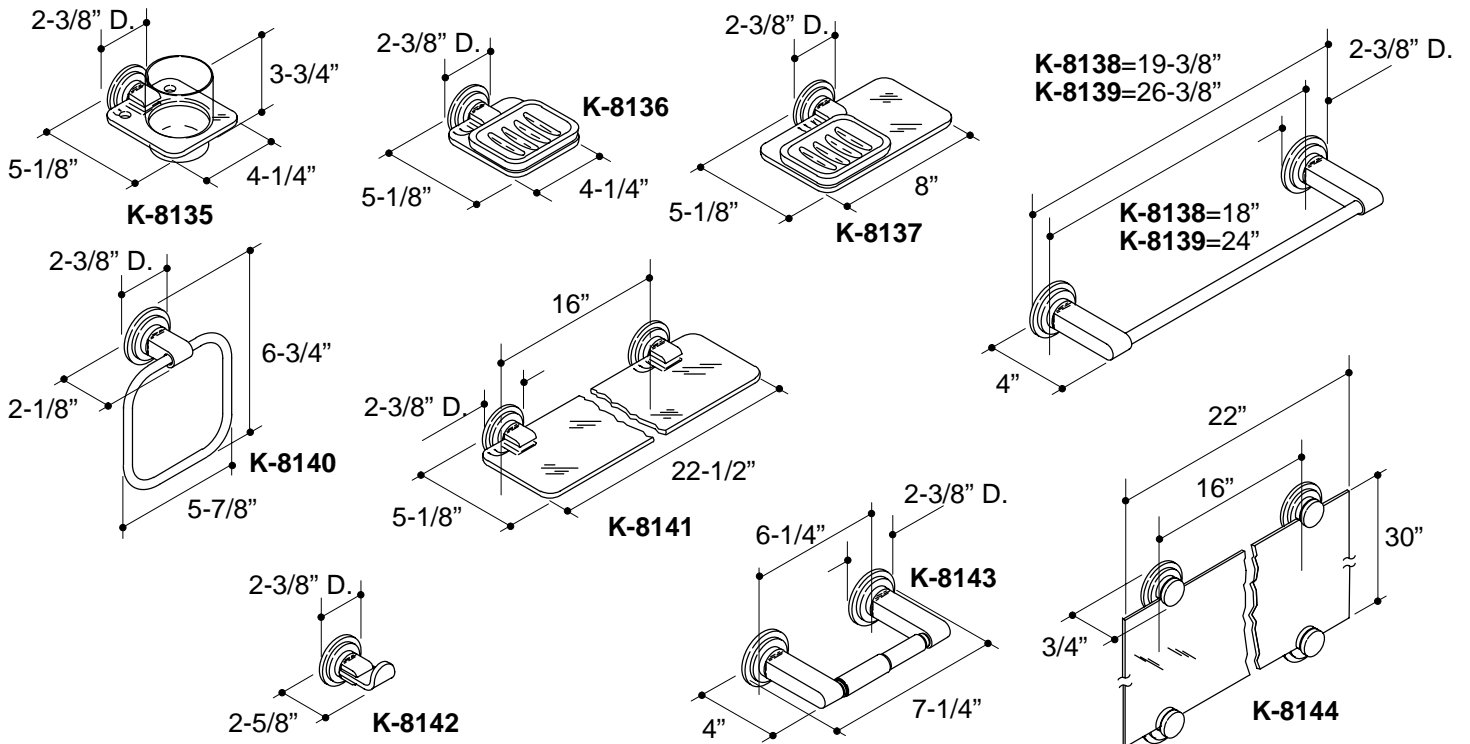

PRODUCT DIAGRAM