

Ordering Information

Applicable product:		
Single-hole sink	K-5901-1	shown
Accessories/hardware:		
Hardwood cutting board	K-5906	optional

Product Information

Fixture*:		basin area	water depth
Sink		12" x 12"	7"
Outlet	3-5/8" D.		
Faucet holes	1-3/8" D.		
* Approximate measurements for comparison only.			

Installation Notes

Refer to installation instructions included with fixture before beginning installation.

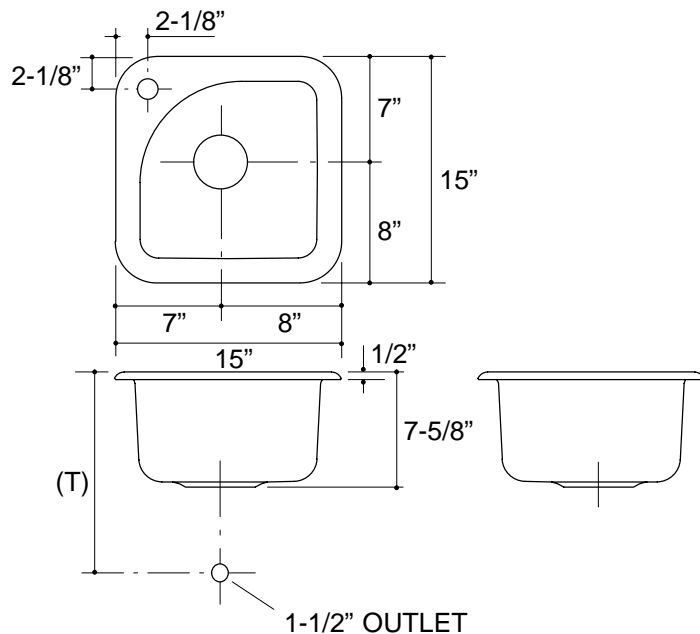

Roughing-In Notes	
Fixture dimensions are nominal and conform to tolerances in ASME/ANSI Standard A112.19.1M.	
(T) Drain typically 13".	
Cutout	13-3/4" x 13-3/4" with 2-1/8" radius corners.

1.25>116