

**BATH AND SHOWER FAUCET TRIM
K-T8224**

ALSO K-T8226, K-T8228, K-304

FEATURES

- Brass construction
- Variety of handle style options

CODES/STANDARDS APPLICABLE

Specified model meets or exceeds the following:

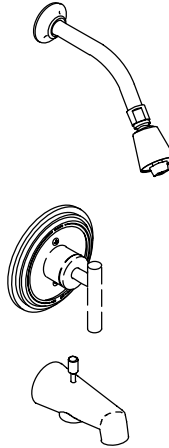

- ASME/ANSI A112.18.1M
- ASSE/ANSI 1016
- CSA B125
- IAPMO/UPC



COLORS/FINISHES

- CP Polished Chrome
- PB Polished Brass
- Other Refer to Faucets Price Book for additional finishes

SPECIFIED MODEL: For complete faucet, both faucet trim and Rite-Temp valve must be specified.

Model	Description		 ADA	 ADA
K-T8224-2	Bath and Shower Trim, Square Handle	<input type="checkbox"/> CP <input type="checkbox"/> PB		
K-T8224-4	Bath and Shower Trim, Lever Handle		<input type="checkbox"/> CP <input type="checkbox"/> PB <input type="checkbox"/> Other_____	
K-T8224-4A	Bath and Shower Trim, Swirl Lever Handle			<input type="checkbox"/> CP <input type="checkbox"/> PB
K-T8226-2	Shower Only Trim, Square Handle	<input type="checkbox"/> CP <input type="checkbox"/> PB		
K-T8226-4	Shower Only Trim, Lever Handle		<input type="checkbox"/> CP <input type="checkbox"/> PB <input type="checkbox"/> Other_____	
K-T8226-4A	Shower Only Trim, Swirl Lever Handle			<input type="checkbox"/> CP <input type="checkbox"/> PB
K-T8228-2	Valve Only Trim, Square Handle	<input type="checkbox"/> CP <input type="checkbox"/> PB		
K-T8228-4	Valve Only Trim, Lever Handle		<input type="checkbox"/> CP <input type="checkbox"/> PB <input type="checkbox"/> Other_____	
K-T8228-4A	Valve Only Trim, Swirl Lever Handle			<input type="checkbox"/> CP <input type="checkbox"/> PB

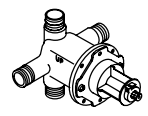
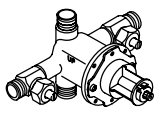
Required Accessory			
K-304-K	Rite-Temp Valve Without Stops	<input type="checkbox"/> NA	
K-304-KS	Rite-Temp Valve With Stops		<input type="checkbox"/> NA

PRODUCT SPECIFICATION:

Rite-Temp pressure-balancing single-control bath and shower faucet trim shall be of brass construction. Bath and shower trim shall include showerhead with arm and flange, 4-7/8" diverter spout with N.P.T. connection, and faceplate with handle. Shower only trim shall include showerhead with arm and flange, and faceplate with handle. Valve only trim shall include faceplate with handle. Faucet trim shall be K-T_____ - _____ - _____ and Rite-Temp valve shall be K-304-_____ -NA.

TABORET®

INSTALLATION NOTES

Avoid cross-flow conditions. Do not install shut-off device on either valve outlet.

Cap shower outlet if deck-mount spout, diverter, or handshower is connected to spout outlet.

Install straight pipe or tube drop of 7 to 18" with single elbow between valve and wall-mount spout.

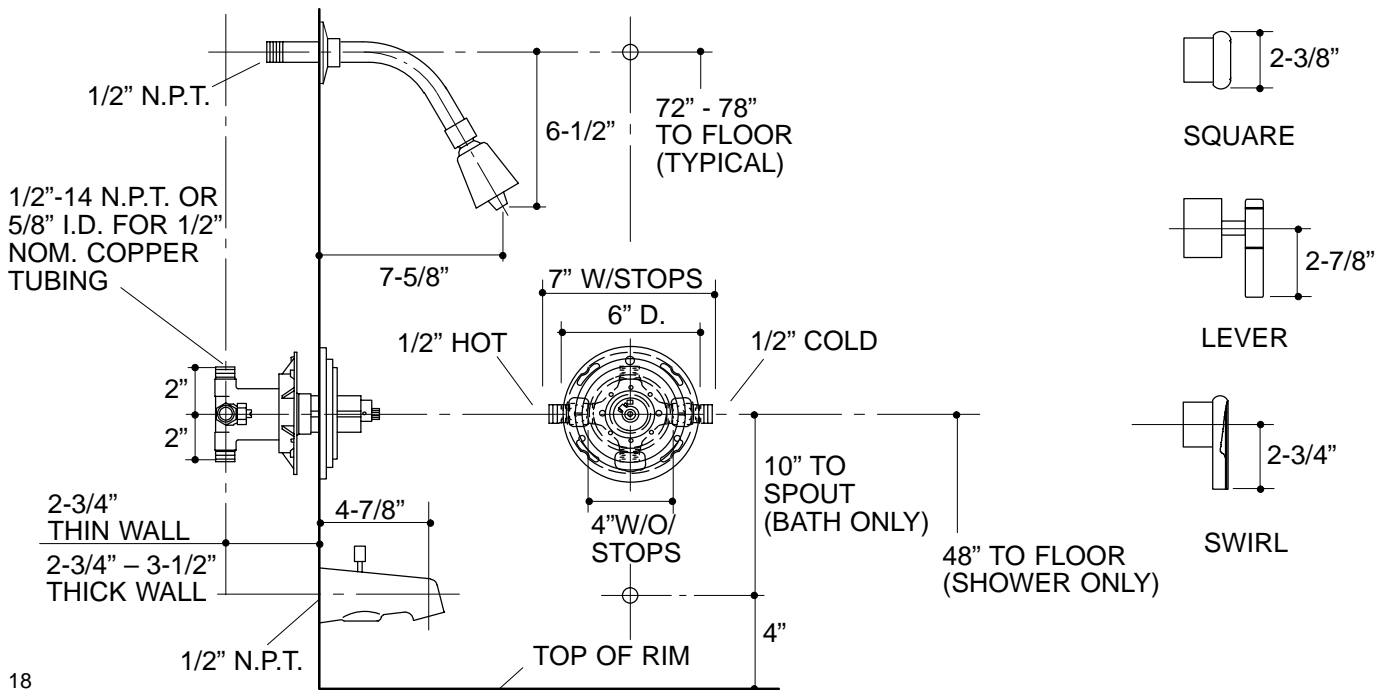

PRODUCT DIAGRAM