

Ordering Information

Accessories/hardware:		
Bottom basin rack	K-3192	optional
Hardwood cutting board	K-3294	optional
Duostrainer® sink strainer	K-8801	optional
Stainless steel sink strainer	K-8813	optional
Stainless steel sink strainer	K-8814	optional

Product Information

Fixture*:		basin area	water depth
Sink		533 x 406mm	51mm
Outlet	Ø92mm		

* Approximate measurements for comparison only.

Included Components:	
Hardware kit	91915
Cutout template	113193

Installation Notes

Refer to installation instructions included with fixture before beginning installation.

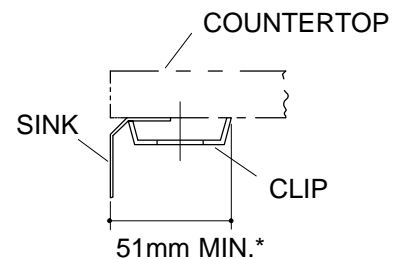
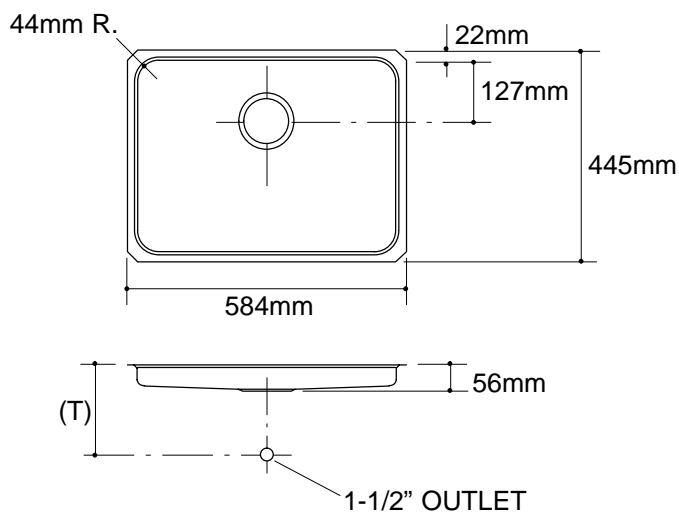

Roughing-In Notes

Fixture dimensions are nominal and conform to tolerances in ASME/ANSI Standard A112.19.3M.

(T) Drain typically 192mm.

*Allow clearance around sink rim for clip attachment.