

Ordering Information

Applicable product:	
1/2" valve system	K-300-K-NA

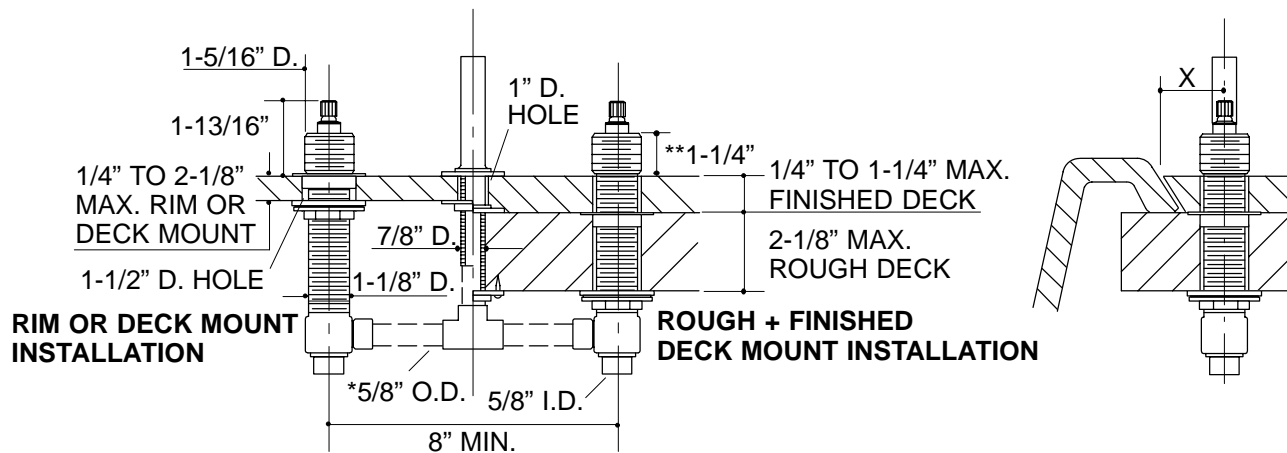

Roughing-In Notes

*Dashed lines indicate items to be supplied by installer.

**Dimension allows +/-1/4" handle adjustment during handle trim installation.

X= Distance from centerline of spout inlet to front of spout base plus 1/2"

For installations on a rough (unfinished) deck to be covered later with tile, the tile thickness must not exceed 1-1/4".