

BATH FAUCET TRIM
K-T7019
ALSO K-300-K

FEATURES

- Brass construction
- Deck-mount
- Cast brass 8-5/8" Roman non-diverter spout with slip-fit connection
- Variety of handle style options

CODES/STANDARDS APPLICABLE

Specified model meets or exceeds the following:



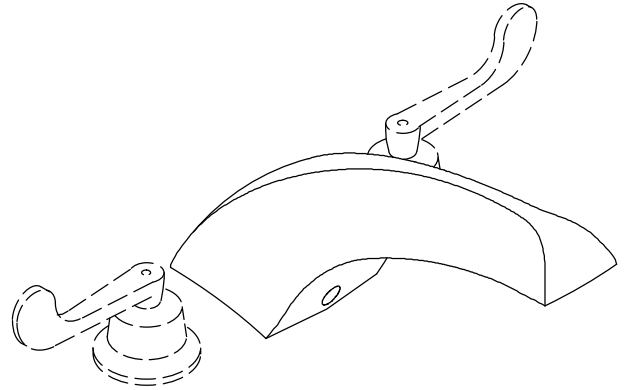

- ASME/ANSI A112.18.1M
- CSA B125
- IAPMO/UPC



COLORS/FINISHES

- CP Polished Chrome

SPECIFIED MODEL: For complete faucet, both faucet trim and valve system must be specified.

Model	Description		 ADA	 ADA	 ADA
K-T7019-2	With Standard Handles	<input type="checkbox"/> CP			
K-T7019-3	With Cross Handles		<input type="checkbox"/> CP		
K-T7019-4	With Lever Handles			<input type="checkbox"/> CP	
K-T7019-5	With Wristblade Handles				<input type="checkbox"/> CP

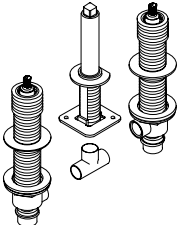
Required Accessory		
K-300-K	1/2" High-Flow Ceramic Disc Valve System	<input type="checkbox"/> NA

PRODUCT SPECIFICATION:

Two-handle deck-mount bath faucet trim shall be of brass construction. Product shall include cast brass 8-5/8" Roman non-diverter spout with slip-fit connection, and handles. Faucet trim shall be Kohler Model K-T7019-____-CP and valve system shall be Kohler Model K-300-K-NA.

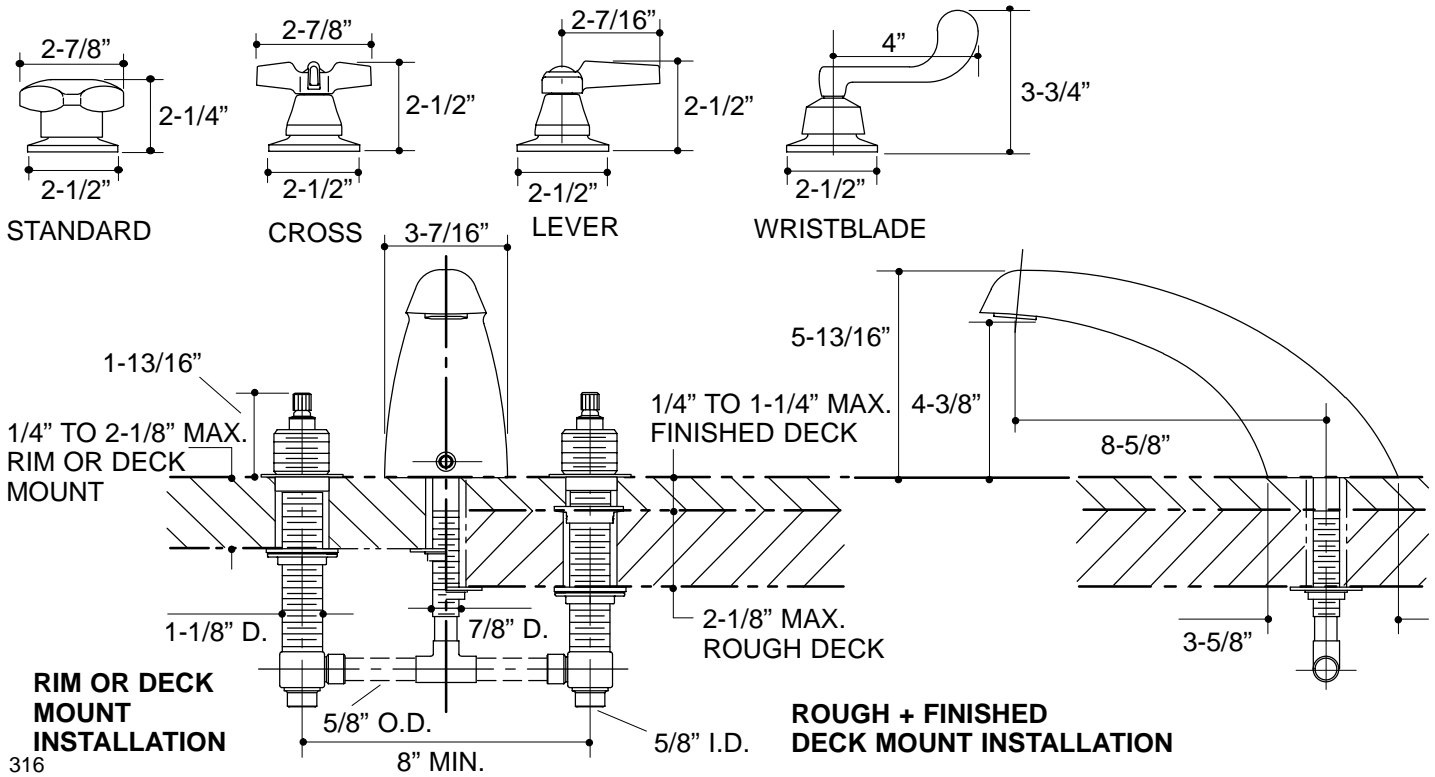

316

PRODUCT DIAGRAM