

**BATH AND SHOWER FAUCET TRIM
K-T612
ALSO K-305**

FEATURES

- Brass construction
- 5-3/4" spout with N.P.T. connection
- Variety of handle style options
- Push-button diverter

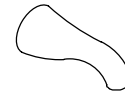
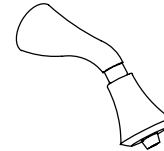

CODES/STANDARDS APPLICABLE



Specified model meets or exceeds the following:

- ASME/ANSI A112.18.1M
- ASSE/ANSI 1016
- CSA B125
- IAPMO/UPC

COLORS/FINISHES

- CP Polished Chrome
- Other Refer to Faucets Price Book for additional finishes

SPECIFIED MODEL:

Model	Description	 ADA	 ADA	 ADA
K-T612-4S	With Scroll Handle and Accent	<input type="checkbox"/> Other_____		
K-T612-4W	With Wrought Swirl Handle and Accent		<input type="checkbox"/> Other_____	
K-T612-4T	With Kudu Handle and Accent			<input type="checkbox"/> CP <input type="checkbox"/> Other_____

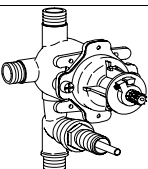
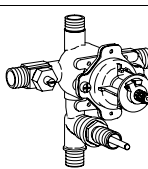
Required Accessory			
K-305-K	Rite-Temp Valve With Push-Button Diverter, Without Stops	<input type="checkbox"/> NA	
K-305-KS	Rite-Temp Valve With Push-Button Diverter, With Stops		<input type="checkbox"/> NA

PRODUCT SPECIFICATION:

Rite-Temp single-control bath and shower faucet trim shall be of brass construction. Product shall include showerhead with arm, 5-3/4" spout with N.P.T. connection, faceplate with handle, and push-button diverter. Faucet trim shall be Kohler Model K-T612-_____-_____- and Rite-Temp valve shall be K-305-_____-NA.

FINIAL ART

INSTALLATION NOTES

Avoid cross-flow conditions. Do not install shut-off device on either valve outlet.

Cap shower outlet if deck-mount spout, diverter, or handshower is connected to spout outlet.

Install straight pipe or tube drop of 7 to 18" with single elbow between valve and wall-mount spout.

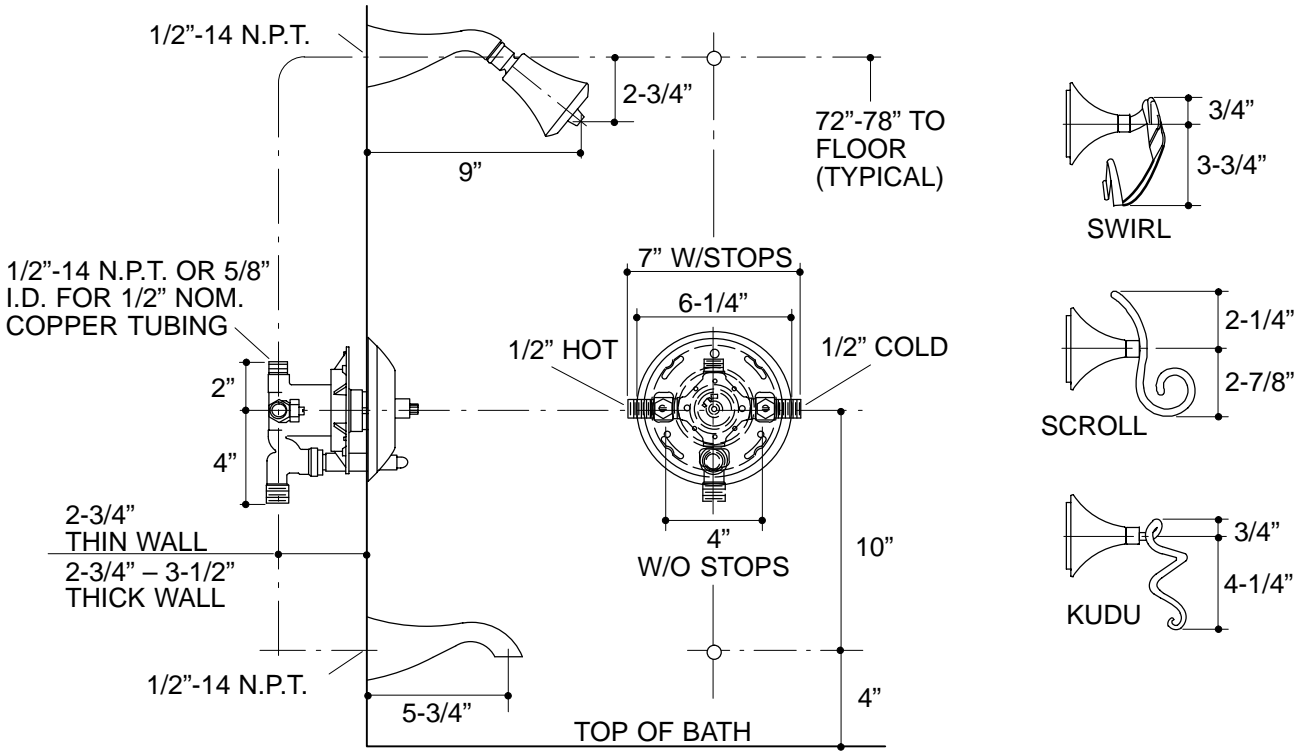

18

PRODUCT DIAGRAM