

**SHOWER FAUCET TRIM
K-T613
ALSO K-T609, K-304**

FEATURES

- Brass construction
- Variety of handle style options

CODES/STANDARDS APPLICABLE

Specified model meets or exceeds the following:

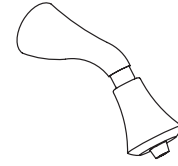

- ASME/ANSI A112.18.1M
- ASSE/ANSI 1016
- CSA B125
- IAPMO/UPC



COLORS/FINISHES

- CP Polished Chrome
- Other Refer to Faucets Price Book for additional finishes

SPECIFIED MODEL: For complete faucet, both faucet trim and Rite-Temp valve must be specified.

Model	Description	 ADA	 ADA	 ADA
K-T613-4S	Shower Only Trim With Scroll Handle and Accent	<input type="checkbox"/> Other _____		
K-T613-4W	Shower Only Trim With Swirl Handle and Accent		<input type="checkbox"/> Other _____	
K-T613-4T	Shower Only Trim With Kudu Handle and Accent			<input type="checkbox"/> CP <input type="checkbox"/> Other _____
K-T609-4W	Valve Only Trim With Swirl Handle and Accent		<input type="checkbox"/> Other _____	
K-T609-4T	Valve Only Trim With Kudu Handle and Accent			<input type="checkbox"/> CP <input type="checkbox"/> Other _____

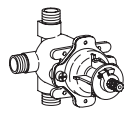
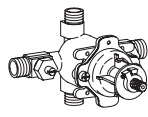
Required Accessory			
K-304-K	Rite-Temp Valve Without Stops	<input type="checkbox"/> NA	
K-304-KS	Rite-Temp Valve With Stops		<input type="checkbox"/> NA

PRODUCT SPECIFICATION:

Rite-Temp pressure-balancing single-control shower faucet trim shall be of brass construction. Shower only trim shall include showerhead with arm, and faceplate with handle. Valve only trim shall include faceplate with handle. Faucet trim shall be Kohler Model K-T____-____-____ and Rite-Temp valve shall be K-304-____-NA.

FINIAL ART

INSTALLATION NOTES

Avoid cross-flow conditions. Do not install shut-off device on either valve outlet.

Cap shower outlet if deck-mount spout, diverter, or handshower is connected to spout outlet.

Install straight pipe or tube drop of 7 to 18" with single elbow between valve and wall-mount spout.

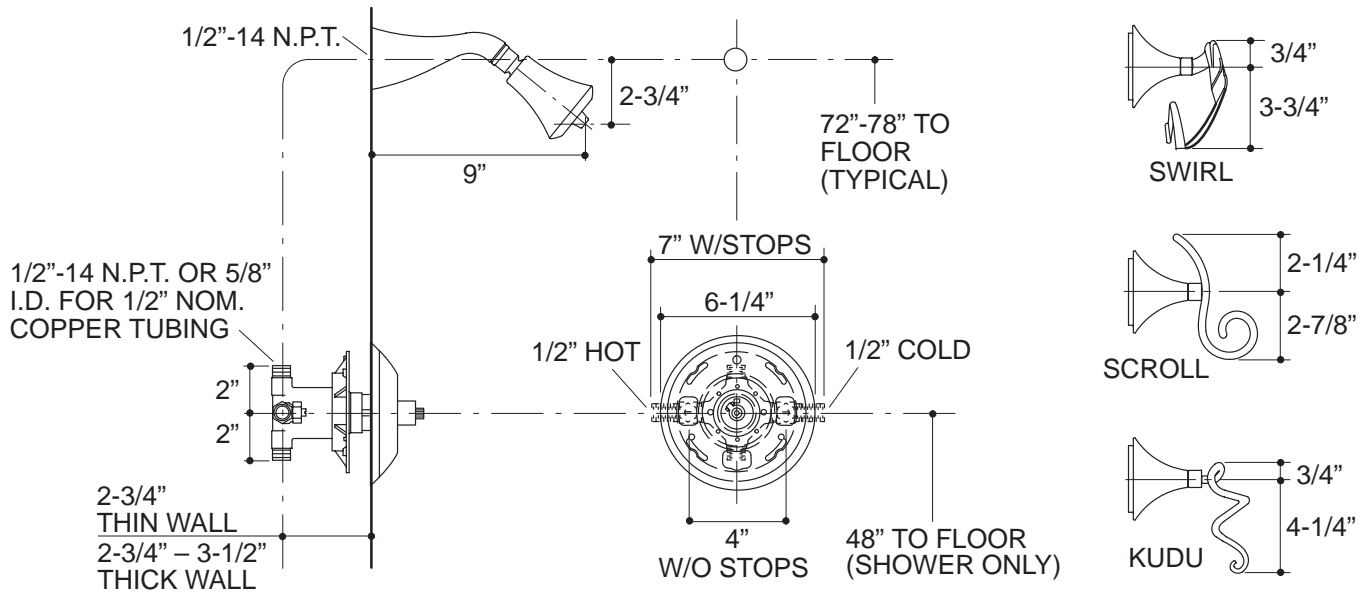

PRODUCT DIAGRAM