

**BATH AND SHOWER FAUCET TRIM
K-P15101
PROJECT PACK
ALSO K-P15701**

FEATURES

- Metal construction
- Available with 4-7/8" diverter bath spout with N.P.T. or slip-fit connection
- Available with lever or sculptured acrylic handle
- Packaged 12 per case

CODES/STANDARDS APPLICABLE

Specified model meets or exceeds the following:

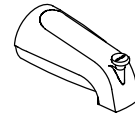
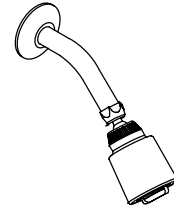

- ASME/ANSI A112.18.1M
- ASSE/ANSI 1016
- CSA B125
- IAPMO/UPC



COLORS/FINISHES

- CP Polished Chrome
- PB Polished Brass
- Other Refer to Faucets Price Book for additional finishes

SPECIFIED MODEL: For complete faucet, both faucet trim and Rite-Temp valve must be specified.

Model	Description		ADA	
Lever Handles:				
K-P15101-4	With N.P.T. Spout	<input type="checkbox"/> CP		
K-P15101-4S	With Slip-Fit Spout	<input type="checkbox"/> CP	<input type="checkbox"/> PB	<input type="checkbox"/> Other_____
Sculptured Acrylic Handles:				
K-P15101-7	With N.P.T. Spout			<input type="checkbox"/> CP
K-P15101-7S	With Slip-Fit Spout			<input type="checkbox"/> CP <input type="checkbox"/> PB <input type="checkbox"/> Other_____

Required and Optional Accessories on Page 2.

PRODUCT SPECIFICATION:

Rite-Temp pressure-balancing single-control bath and shower faucet trim shall be of metal construction. Product shall include showerhead with arm and flange, faceplate with lever or sculptured acrylic handle, and 4-7/8" diverter bath spout with N.P.T. or slip-fit connection. Faucet trim shall be Kohler Model K-P15101-_____-_____- and Rite-Temp valve shall be Kohler Model K-P15701-_____-NA. Project pack valves and trim are packaged twelve per case.

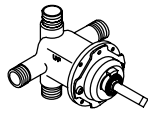
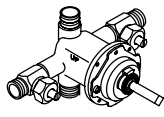
Required Accessory			
K-P15701-K	Coralais Rite-Temp Pressure-Balancing Valve, Less Stops	<input type="checkbox"/> NA	
K-P15701-KS	Coralais Rite-Temp Pressure-Balancing Valve, With Stops		<input type="checkbox"/> NA

INSTALLATION NOTES

Avoid cross-flow conditions. Do not install shut-off device on either valve outlet.

Cap shower outlet if deck-mount spout, diverter, or handshower is connected to spout outlet.

Install straight pipe or tube drop of 7 to 18" with single elbow between valve and wall-mount spout.

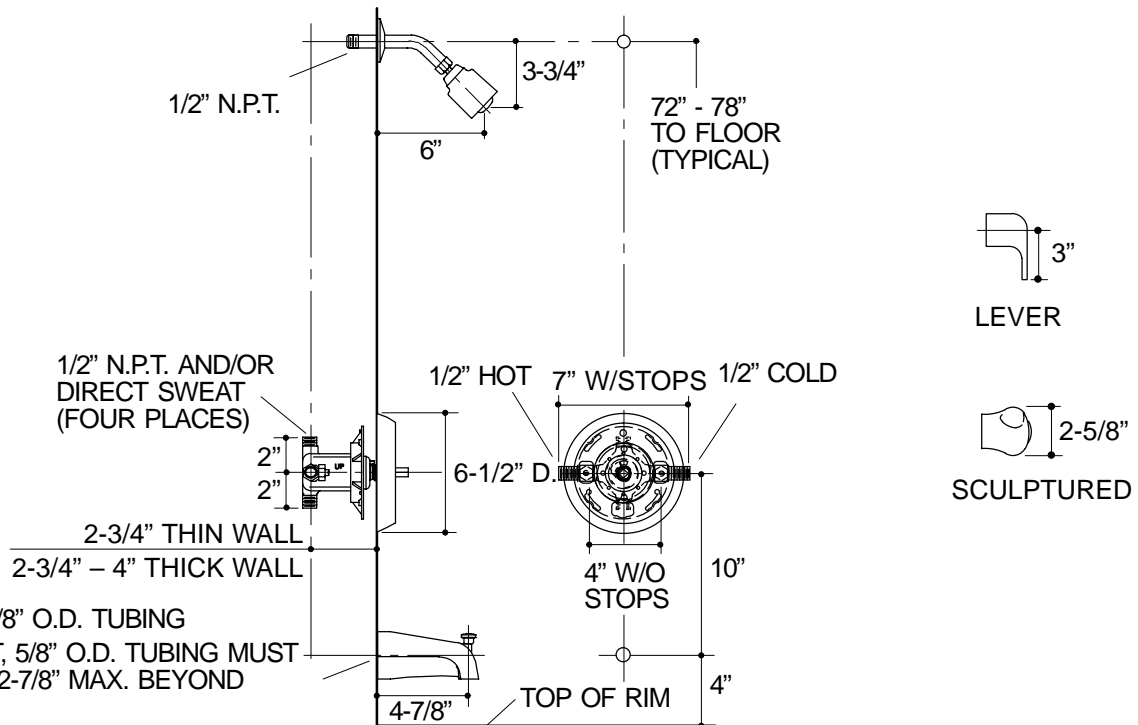

332

PRODUCT DIAGRAM