

FEATURES



- Brass construction
- Traditional styling
- Completes IV Georges Brass faucet line

COLORS/FINISHES

- CP Polished Chrome
- PB Polished Brass
- Other Refer to Faucets Price Book for additional finishes

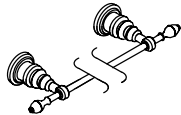
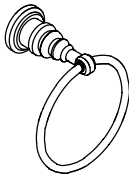
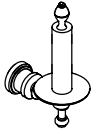
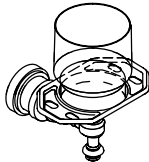
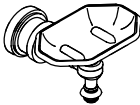
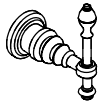
SPECIFIED MODEL:

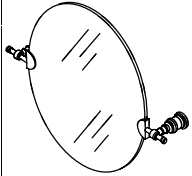
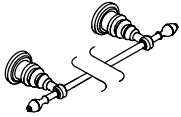
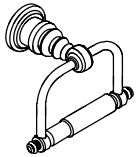
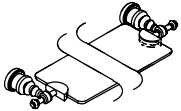
Model/Description	
IV Georges Brass 18" Towel Bar <input type="checkbox"/> K-6816 <input type="checkbox"/> K-6816-A <input type="checkbox"/> K-6816-B <input type="checkbox"/> K-6816-C Refer to Faucets Price Book for a variety of finishes and accents. <input type="checkbox"/> PB <input type="checkbox"/> Other_____	
IV Georges Brass Towel Ring <input type="checkbox"/> K-6817 <input type="checkbox"/> K-6817-A <input type="checkbox"/> K-6817-B <input type="checkbox"/> K-6817-C Refer to Faucets Price Book for a variety of finishes and accents. <input type="checkbox"/> PB <input type="checkbox"/> Other_____	
K-6818 IV Georges Brass Vertical Toilet Tissue Holder <input type="checkbox"/> PB <input type="checkbox"/> Other_____	
K-6819-GD IV Georges Brass Tumbler and Toothbrush Holder; includes glass tumbler <input type="checkbox"/> PB <input type="checkbox"/> Other_____	
K-6820 IV Georges Brass Soap Dish; includes removable clear acrylic dish <input type="checkbox"/> PB <input type="checkbox"/> Other_____	
K-6821 IV Georges Brass Robe Hook <input type="checkbox"/> PB <input type="checkbox"/> Other_____	

Model/Description	
K-6824 IV Georges Brass Mirror <input type="checkbox"/> Other_____	
IV Georges Brass 24" Towel Bar <input type="checkbox"/> K-6826 <input type="checkbox"/> K-6826-A <input type="checkbox"/> K-6826-B <input type="checkbox"/> K-6826-C Refer to Faucets Price Book for a variety of finishes and accents. <input type="checkbox"/> PB <input type="checkbox"/> Other_____	
K-6828 IV Georges Brass Horizontal Toilet Tissue Holder <input type="checkbox"/> PB <input type="checkbox"/> Other_____	
K-6829 IV Georges Brass Glass Shelf <input type="checkbox"/> PB <input type="checkbox"/> Other_____	
K-6796 IV Georges Brass Accent Kit for K-6818, K-6819, K-6820, and *K-6829 *K-6829 requires two kits <input type="checkbox"/> PB <input type="checkbox"/> Other_____	
K-6798 IV Georges Brass Accent Kit for K-6821 and K-6828 <input type="checkbox"/> PB <input type="checkbox"/> Other_____	

IV GEORGES BRASS™

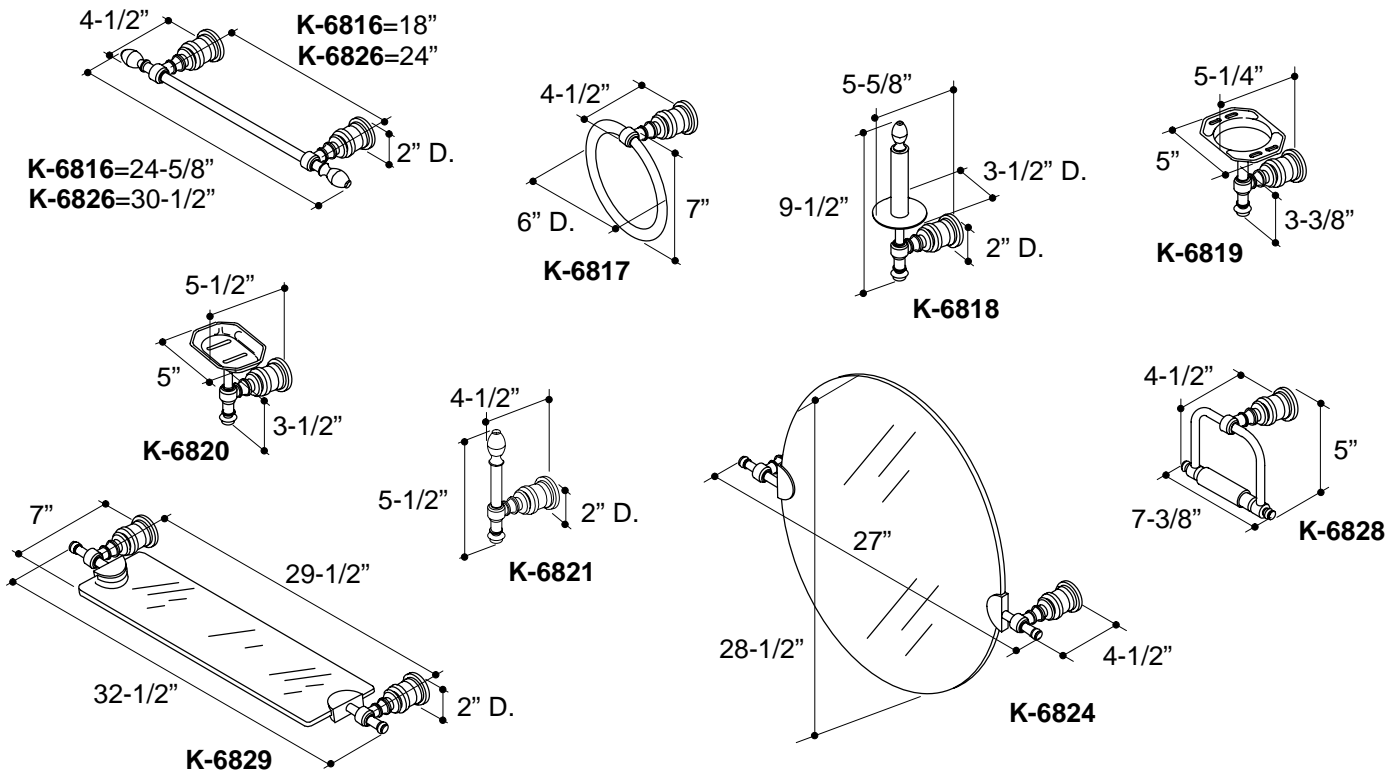

PRODUCT DIAGRAM