

Ordering Information

Applicable faucet:	
Square handles	K-6954-2
Lever handles	K-6954-4
ADA Lever handles are ADA compliant	

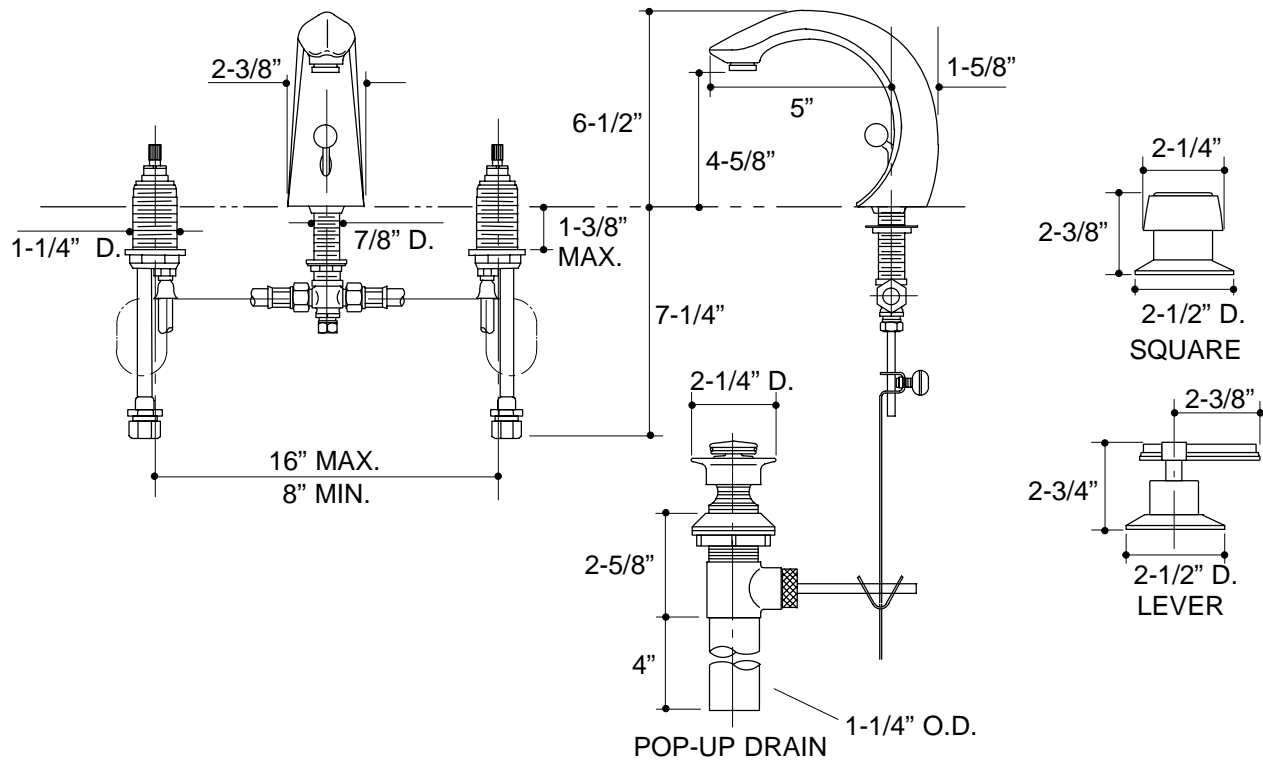

316

K-6954 Alterna™ Lavatory Faucet
115045-1-AA (9619)

KOHLER®

NOTES: