

**LAVATORY FAUCET
K-7404-K
ALSO K-7404**

FEATURES

- Brass construction
- For 4" centers
- Brass valve bodies
- Quarter-turn washerless ceramic disc valves
- 4" spout
- Available with standard or vandal-resistant Water-Guard® aerator, or rosespray
- 2.0 gallons per minute
- Variety of handle style options

CODES/STANDARDS APPLICABLE

Specified model meets or exceeds the following:

- ASME/ANSI A112.18.1M
- CSA B125
- Energy Policy Act of 1992
- IAPMO/UPC
- NSF 61

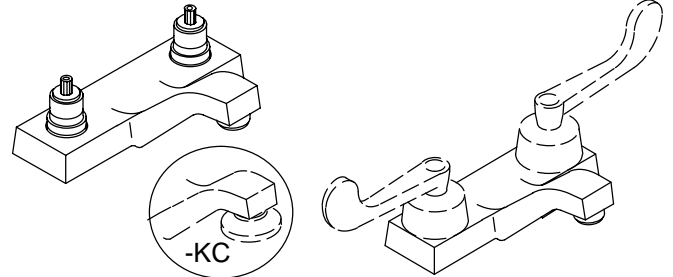

K-7404-K

K-7404





COLORS/FINISHES

- CP Polished Chrome



SPECIFIED MODEL:

BASE FAUCET: For complete faucet, both base faucet and handle choice must be specified.

Model	Description	
K-7404-K	With Standard Aerator	<input type="checkbox"/> CP
K-7404-KE	With Vandal-Resistant Aerator	<input type="checkbox"/> CP
K-7404-KC	With Rosespray	<input type="checkbox"/> CP

Required Accessory (Includes Two Handles)			 ADA	 ADA	 ADA	 ADA
K-16010-2	Triton Standard Handles	<input type="checkbox"/> CP				
K-16010-3	Triton Cross Handles		<input type="checkbox"/> CP			
K-16010-4	Triton Lever Handles			<input type="checkbox"/> CP		
K-16010-5	Triton Wristblade Lever Handles				<input type="checkbox"/> CP	
K-16050-5	Finesse Wrist Control Lever Handles					<input type="checkbox"/> CP

COMPLETE FAUCET: Faucet handles included.

Model	Description		 ADA
K-7404-2A	With Standard Handles and Standard Aerator	<input type="checkbox"/> CP	
K-7404-5A	With Wristblade Handles and Standard Aerator		<input type="checkbox"/> CP

Optional Accessory on Page 2.

PRODUCT SPECIFICATION:
 Two-handle centerset lavatory faucet shall be of brass construction. Faucet shall feature brass valve bodies. Faucet shall feature quarter-turn washerless ceramic disc valves, assuring positive handle stop positioning. Product shall be less drain and lift rod. Product shall include 4" centers, and 4" spout. Optional feature shall be standard or vandal-resistant Water-Guard aerator, or rosespray. Base faucet shall be Kohler Model K-7404-_____-CP with K-_____-_____-CP handles **OR** complete faucet shall be Kohler Model K-7404-_____-CP.

TRITON™ /FINESSE™

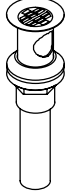
Optional Accessory			
K-7715	Grid Drain	<input type="checkbox"/> CP	<input type="checkbox"/> PB

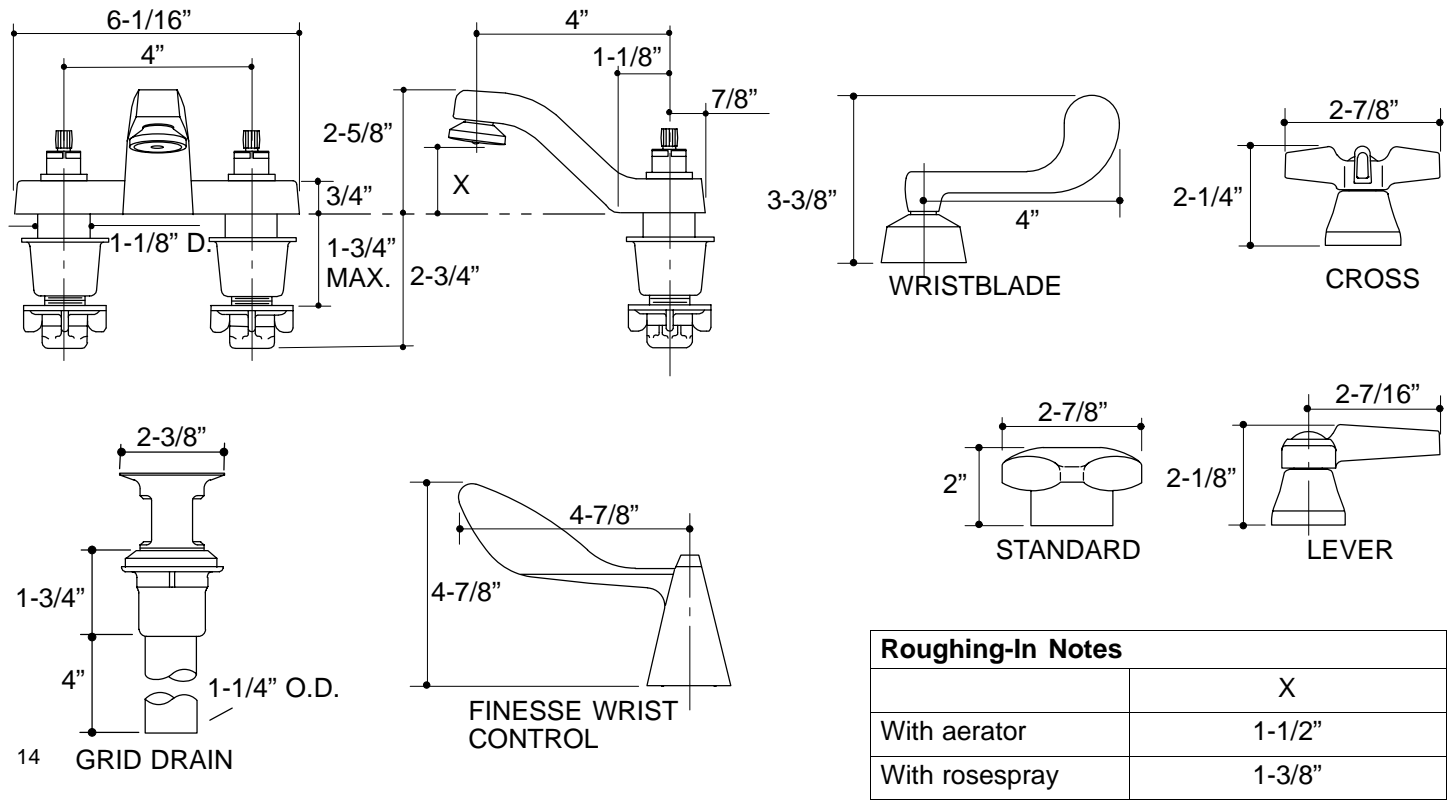

PRODUCT DIAGRAM