

Titen HD® Design Information — Concrete

Titen HD® Tension Strength Design Data¹

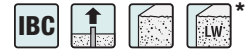

Characteristic	Symbol	Units	Nominal Anchor Diameter, d _a (in.)									
			1/4 ⁹		3/8		1/2		5/8 ⁹		3/4	
Nominal Embedment Depth	<i>h_{nom}</i>	in.	1 5/8	2 1/2	2 1/2	3 1/4	3 1/4	4	4	5 1/2	5 1/2	6 1/4
Steel Strength in Tension												
Tension Resistance of Steel	<i>N_{sa}</i>	lb.	5,195		10,890		20,130		30,360		45,540	
Strength Reduction Factor — Steel Failure	<i>φ_{sa}</i>	—	0.65 ²									
Concrete Breakout Strength in Tension^{6,8}												
Effective Embedment Depth	<i>h_{ef}</i>	in.	1.19	1.94	1.77	2.40	2.35	2.99	2.97	4.24	4.22	4.86
Critical Edge Distance ⁶	<i>c_{ac}</i>	in.	3	6	2 11/16	3 5/8	3 9/16	4 1/2	4 1/2	6 3/8	6 3/8	7 5/16
Effectiveness Factor — Uncracked Concrete	<i>k_{un-cr}</i>	—	30		24							
Effectiveness Factor — Cracked Concrete	<i>k_{cr}</i>	—	17									
Modification Factor	<i>ψ_{cp,N}</i>	—	1.0									
Strength Reduction Factor — Concrete Breakout Failure	<i>φ_{cb}</i>	—	0.65 ⁷									
Pullout Strength in Tension⁸												
Pullout Resistance, Uncracked Concrete (<i>f'_c</i> =2,500 psi)	<i>N_{p,un-cr}</i>	lb.	— ³	— ³	2,700 ⁴	— ³	— ³	— ³	— ³	9,810 ⁴	— ³	— ³
Pullout Resistance, Cracked Concrete (<i>f'_c</i> =2,500 psi)	<i>N_{p,cr}</i>	lb.	— ³	1,905 ⁴	1,235 ⁴	2,700 ⁴	— ³	— ³	3,260 ⁴	5,570 ⁴	6,070 ⁴	7,195 ⁴
Strength Reduction Factor — Concrete Pullout Failure	<i>φ_p</i>	—	0.65 ⁵									
Breakout or Pullout Strength in Tension for Seismic Applications⁸												
Nominal Pullout Strength for Seismic Loads (<i>f'_c</i> =2,500 psi)	<i>N_{p,eq}</i>	lb.	— ³	1,905 ⁴	1,235 ⁴	2,700 ⁴	— ³	— ³	3,260 ⁴	5,570 ⁴	6,070 ⁴	7,195 ⁴
Strength Reduction Factor — Breakout or Pullout Failure	<i>φ_{eq}</i>	—	0.65 ⁵									

- The information presented in this table is to be used in conjunction with the design criteria of ACI 318 Appendix D, except as modified below.
- The value of *φ* applies when the load combinations of ACI 318 Section 9.2 are used. If the load combinations of ACI 318 Appendix C are used, refer to Section D.4.4 to determine the appropriate value of *φ*. Anchors are considered brittle steel elements.
- Pullout strength is not reported since concrete breakout controls.
- Adjust the characteristic pullout resistance for other concrete compressive strengths by multiplying the tabular value by (*f'_{c,specified}* / 2,500)^{0.5}.
- The value of *φ* applies when both the load combinations of ACI 318 Section 9.2 are used and the requirements of Section D.4.3(c) for Condition B are met. If the load combinations of ACI 318 Appendix C are used, refer to Section D.4.4 to determine the appropriate value of *φ*.
- The modification factor *ψ_{cp,N}* = 1.0 for cracked concrete. Otherwise, the modification factor for uncracked concrete without supplementary reinforcement to control splitting is either:

$$(1) \psi_{cp,N} = 1.0 \text{ if } c_{a,min} \geq c_{ac} \text{ or } (2) \psi_{cp,N} = \frac{c_{a,min}}{c_{ac}} \geq \frac{1.5h_{ef}}{c_{ac}} \text{ if } c_{a,min} < c_{ac}$$

The modification factor, *ψ_{cp,N}* is applied to the nominal concrete breakout strength, *N_{cb}* or *N_{cbg}*.

- The value of *φ* applies when both the load combinations of ACI 318 Section 9.2 are used and the requirements of Section D.4.3(c) for Condition B are met. If the load combinations of ACI 318 Section 9.2 are used and the requirements of Section D.4.3(c) for Condition A are met, refer to Section D.4.3 to determine the appropriate value of *φ*. If the load combinations of ACI 318 Appendix C are used, refer to Section D.4.4 to determine the appropriate value of *φ*.
- For sand-lightweight concrete, in lieu of ACI 318 Section D.3.6, modify the value of concrete breakout strength, *N_{p,cr}*, *N_{p,un-cr}* and *N_{eq}* by 0.6. All-lightweight concrete is beyond the scope of this table.
- Data for 1/4" anchor is valid only for THDB25 series. Data for 5/8" anchor is valid only for THDB62 series.

Mechanical Anchors

Titen HD® Shear Strength Design Data¹



Characteristic	Symbol	Units	Nominal Anchor Diameter, d _a (in.)									
			1/4 ⁵		3/8		1/2		5/8 ⁵		3/4	
Nominal Embedment Depth	<i>h_{nom}</i>	in.	1 5/8	2 1/2	2 1/2	3 1/4	3 1/4	4	4	5 1/2	5 1/2	6 1/4
Steel Strength in Shear												
Shear Resistance of Steel	<i>V_{sa}</i>	lb.	2,020		4,460		7,455		10,000		16,840	
Strength Reduction Factor — Steel Failure	<i>φ_{sa}</i>	—	0.60 ²									
Concrete Breakout Strength in Shear⁶												
Outside Diameter	<i>d_a</i>	in.	0.25		0.375		0.500		0.625		0.750	
Load Bearing Length of Anchor in Shear	<i>ℓ_e</i>	in.	1.19	1.94	1.77	2.40	2.35	2.99	2.97	4.24	4.22	4.86
Strength Reduction Factor — Concrete Breakout Failure	<i>φ_{cb}</i>	—	0.70 ⁴									
Concrete Pryout Strength in Shear												
Coefficient for Pryout Strength	<i>k_{cp}</i>	lb.	1.0		2.0							
Strength Reduction Factor — Concrete Pryout Failure	<i>φ_{cp}</i>	—	0.70 ⁴									
Steel Strength in Shear for Seismic Applications												
Shear Resistance for Seismic Loads	<i>V_{eq}</i>	lb.	1,695		2,855		4,790		8,000		9,350	
Strength Reduction Factor — Steel Failure	<i>φ_{eq}</i>	—	0.60 ²									

- The information presented in this table is to be used in conjunction with the design criteria of ACI 318 Appendix D, except as modified below.
- The value of *φ* applies when the load combinations of ACI 318 Section 9.2 are used. If the load combinations of ACI 318 Appendix C are used, refer to Section D.4.4 to determine the appropriate value of *φ*. Anchors are considered brittle steel elements.
- The value of *φ* applies when both the load combinations of ACI 318 Section 9.2 are used and the requirements of Section D.4.3(c) for Condition B are met. If the load combinations of ACI 318 Appendix C are used, refer to Section D.4.4 to determine the appropriate value of *φ*. If the load combinations of ACI 318 Appendix C are used,

refer to Section D.4.4 to determine the appropriate value of *φ*.

- The value of *φ* applies when both the load combinations of ACI 318 Section 9.2 are used and the requirements of Section D.4.3(c) for Condition B are met. If the load combinations of ACI 318 Appendix C are used, refer to Section D.4.4 to determine the appropriate value of *φ*.
- Data for 1/4" anchor is valid only for THDB25 series. Data for 5/8" anchor is valid only for THDB62 series.
- For sand-lightweight concrete, in lieu of ACI 318 Section D.3.6, modify the value of concrete breakout strength by 0.6. All-lightweight concrete is beyond the scope of this table.

* See page 12 for an explanation of the load table icons.

Titen HD® Design Information — Concrete

Titen HD® Tension and Shear Strength Design Data for the Soffit of Normal-Weight or Sand-Lightweight Concrete over Metal Deck^{1,6,8}

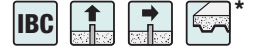

Characteristic	Symbol	Units	Nominal Anchor Diameter, d_a (in.)									
			Lower Flute				Upper Flute					
			Figure 2		Figure 1		Figure 2		Figure 1			
			$\frac{1}{4}^{\#}$	$\frac{3}{8}$	$\frac{1}{2}$	$\frac{3}{4}$	$1\frac{1}{2}$	$1\frac{3}{4}$	2			
Nominal Embedment Depth	h_{nom}	in.	1 $\frac{1}{8}$	2 $\frac{1}{2}$	1 $\frac{7}{8}$	2 $\frac{1}{2}$	2	3 $\frac{1}{2}$	1 $\frac{5}{8}$	2 $\frac{1}{2}$	1 $\frac{7}{8}$	2
Effective Embedment Depth	h_{ef}	in.	1.19	1.94	1.23	1.77	1.29	2.56	1.19	1.94	1.23	1.29
Pullout Resistance, concrete on metal deck (cracked) ^{2,3,4}	$N_{p,deck,cr}$	lb.	420	535	375	870	905	2,040	655	1,195	500	1,700
Pullout Resistance, concrete on metal deck (uncracked) ^{2,3,4}	$N_{p,deck,uncr}$	lb.	995	1,275	825	1,905	1,295	2,910	1,555	2,850	1,095	2,430
Steel Strength in Shear, concrete on metal deck ⁵	$V_{sa,deck}$	lb.	1,335	1,745	2,240	2,395	2,435	4,430	2,010	2,420	4,180	7,145
Steel Strength in Shear, Seismic	$V_{sa,deck,eq}$	lb.	870	1,135	1,434	1,533	1,556	2,846	1,305	1,575	2,676	4,591

- The information presented in this table is to be used in conjunction with the design criteria of ACI 318 Appendix D, except as modified below.
- Concrete compressive strength shall be 3,000 psi minimum. The characteristic pullout resistance for greater compressive strengths shall be increased by multiplying the tabular value by $(f'_{c,specified} / 3,000)^{0.5}$.
- For anchors installed in the soffit of sand-lightweight or normal-weight concrete over metal deck floor and roof assemblies, as shown in Figure 1 and Figure 2, calculation of the concrete breakout strength may be omitted.
- In accordance with ACI 318 Section D.5.3.2, the nominal pullout strength in cracked concrete for anchors installed in the soffit of sand-lightweight or normal-weight concrete over metal deck floor and roof assemblies $N_{p,deck,cr}$

- shall be substituted for $N_{p,cr}$. Where analysis indicates no cracking at service loads, the normal pullout strength in uncracked concrete $N_{p,deck,uncr}$ shall be substituted for $N_{p,uncr}$.
- In accordance with ACI 318 Section D.6.1.2(c), the shear strength for anchors installed in the soffit of sand-lightweight or normal-weight concrete over metal deck floor and roof assemblies $V_{sa,deck}$ and $V_{sa,deck,eq}$ shall be substituted for V_{sa} .
- Minimum edge distance to edge of panel is $2h_{ef}$.
- The minimum anchor spacing along the flute must be the greater of $3h_{ef}$ or 1.5 times the flute width.
- Data for $\frac{1}{4}$ " anchor is valid only for THDB25 series.

Titen HD® Anchor Tension and Shear Strength Design Data in the Topside of Normal-Weight Concrete or Sand-Lightweight Concrete over Metal Deck



Design Information	Symbol	Units	Nominal Anchor Diameter, d_a	
			Figure 3	Figure 2
			$\frac{1}{4}$ "	$\frac{3}{8}$ "
Nominal Embedment Depth	h_{nom}	in.	1 $\frac{1}{8}$	2 $\frac{1}{2}$
Effective Embedment Depth	h_{ef}	in.	1.19	1.77
Minimum Concrete Thickness	$h_{min,deck}$	in.	2 $\frac{1}{2}$	3 $\frac{1}{4}$
Critical Edge Distance	$c_{ac,deck,top}$	in.	3 $\frac{3}{4}$	7 $\frac{1}{4}$
Minimum Edge Distance	$c_{min,deck,top}$	in.	3 $\frac{1}{2}$	3
Minimum Spacing	$s_{min,deck,top}$	in.	3 $\frac{1}{2}$	3

- For anchors installed in the topside of concrete-filled deck assemblies, as shown in Figures 2 and 3, the nominal concrete breakout strength of a single anchor or group of anchors in shear, V_{cp} or V_{cbg} , respectively, must be calculated in accordance with ACI 318 D.6.2, using the actual member thickness, $h_{min,deck}$, in the determination of A_{vc} .
- Design capacity shall be based on calculations according to values in the tables featured on pages 185 and 186.
- Minimum flute depth (distance from top of flute to bottom of flute) is 1 $\frac{1}{2}$ inch (see Figures 2 and 3).
- Steel deck thickness shall be minimum 20 gauge.
- Minimum concrete thickness ($h_{min,deck}$) refers to concrete thickness above upper flute (see Figures 2 and 3).

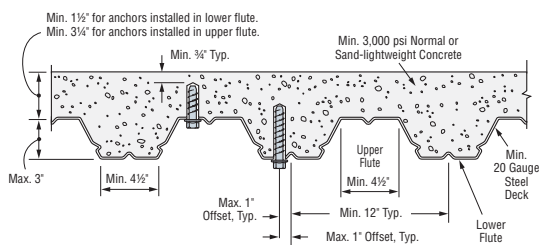

Figure 1. Installation of $\frac{3}{8}$ " and $\frac{1}{2}$ " Diameter Anchors in the Soffit of Concrete over Metal Deck

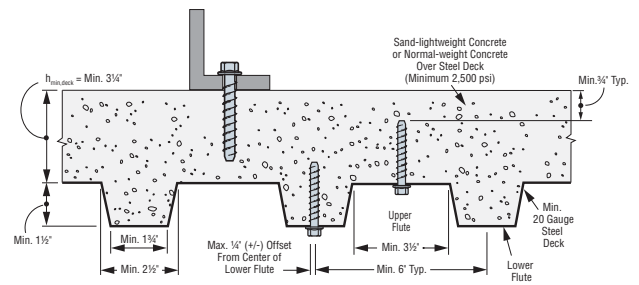

Figure 2. Installation of $\frac{3}{8}$ " Diameter Anchors in the Topside and $\frac{1}{4}$ " Diameter Anchors in the Soffit of Concrete over Metal Deck

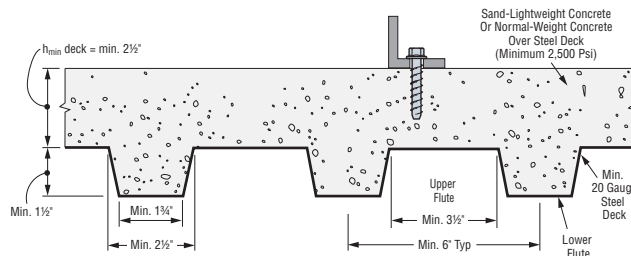

Figure 3. Installation of $\frac{1}{4}$ " Diameter Anchors in the Topside of Concrete over Metal Deck

* See page 12 for an explanation of the load table icons.

Titen HD® Design Information — Concrete



Titen HD® Tension Design Strengths in Normal-Weight Concrete ($f'_c = 2,500$ psi)

Anchor Dia. (in.)	Nominal Embed. Depth (in.)	Min. Concrete Thickness h_{min} (in.)	Critical Edge Distance c_{ac} (in.)	Minimum Edge Distance c_{min} (in.)	Tension Design Strength (lb.)							
					Edge Distances = c_{ac} on all sides				Edge Distances = c_{min} on one side and c_{ac} on three sides			
					SDC A-B ⁵		SDC C-F ^{6,7}		SDC A-B ⁵		SDC C-F ^{6,7}	
					Uncracked	Cracked	Uncracked	Cracked	Uncracked	Cracked	Uncracked	Cracked
1/4	1 5/8	3 1/4	3	1 1/2	1,265	715	950	540	660	630	495	470
	2 1/2	3 1/2	6	1 1/2	2,110	1,240	1,580	930	660	965	495	725
3/8	2 1/2	4	2 1/16	1 3/4	1,755	805	1,315	600	1,350	805	1,015	600
	3 1/4	5	3 3/8	1 3/4	2,900	1,755	2,175	1,315	1,810	1,290	1,360	970
1/2	3 1/4	5	3 9/16	1 3/4	2,810	1,990	2,105	1,495	1,765	1,265	1,325	950
	4	6 1/4	4 1/2	1 3/4	4,035	2,855	3,025	2,140	2,285	1,620	1,710	1,220
5/8	4	6	4 1/2	1 3/4	3,990	1,975	2,995	1,480	2,250	1,610	1,690	1,210
	5 1/2	8 1/2	6 3/8	1 3/4	6,375	3,620	4,780	2,715	3,390	2,405	2,540	1,805
3/4	5 1/2	8 3/4	6 3/8	1 3/4	6,760	3,945	5,070	2,960	3,355	2,395	2,515	1,795
	6 1/4	10	7 5/16	1 3/4	8,355	4,675	6,265	3,510	3,990	2,835	2,990	2,125

1. Tension design strengths are based on the strength design provisions of ACI 318-11 Appendix D.
2. Tabulated values are for a single anchor with no influence of another anchor.
3. Interpolation between embedment depths is not permitted.
4. Strength reduction factor, ϕ , is based on using a load combination from ACI 318-11 Section 9.2.
5. The tension design strength listed for SDC (Seismic Design Category) A-B may also be used in SDC C-F when the tension component of the strength-level seismic design load on the anchor does not exceed 20% of the total factored tension load on the anchor associated with the same load combination.
6. When designing anchorages in SDC C-F, the designer shall consider the ductility requirements of ACI 318-11 Section D.3.3.
7. Tension design strengths in SDC C-F have been adjusted by 0.75 factor in accordance with ACI 318-11 Section D.3.3.4.4.



Titen HD® Allowable Tension Loads in Normal-Weight Concrete ($f'_c = 2,500$ psi) — Static Load

Anchor Dia. (in.)	Nominal Embed. Depth (in.)	Min. Concrete Thickness h_{min} (in.)	Critical Edge Distance c_{ac} (in.)	Minimum Edge Distance c_{min} (in.)	Allowable Tension Load (lb.)			
					Edge Distances = c_{ac} on all sides		Edge Distances = c_{min} on one side and c_{ac} on three sides	
					Uncracked	Cracked	Uncracked	Cracked
1/4	1 5/8	3 1/4	3	1 1/2	905	510	470	450
	2 1/2	3 1/2	6	1 1/2	1,505	885	470	690
3/8	2 1/2	4	2 1/16	1 3/4	1,255	575	965	575
	3 1/4	5	3 3/8	1 3/4	2,070	1,255	1,295	920
1/2	3 1/4	5	3 9/16	1 3/4	2,005	1,420	1,260	905
	4	6 1/4	4 1/2	1 3/4	2,880	2,040	1,630	1,155
5/8	4	6	4 1/2	1 3/4	2,850	1,410	1,605	1,150
	5 1/2	8 1/2	6 3/8	1 3/4	4,555	2,585	2,420	1,720
3/4	5 1/2	8 3/4	6 3/8	1 3/4	4,830	2,820	2,395	1,710
	6 1/4	10	7 5/16	1 3/4	5,970	3,340	2,850	2,025

1. Allowable tension loads are calculated based on the strength design provision of ACI 318-11 Appendix D using a conversion factor of $\alpha = 1.4$. The conversion factor α is based on the load combination 1.2D + 1.6L assuming 50% dead load and 50% live load: $1.2(0.5) + 1.6(0.5) = 1.4$.
2. Tabulated values are for a single anchor with no influence of another anchor.
3. Interpolation between embedment depths is not permitted.



Titen HD® Allowable Tension Loads in Normal-Weight Concrete ($f'_c = 2,500$ psi) — Wind Load

Anchor Dia. (in.)	Nominal Embed. Depth (in.)	Min. Concrete Thickness h_{min} (in.)	Critical Edge Distance c_{ac} (in.)	Minimum Edge Distance c_{min} (in.)	Allowable Tension Load (lb.)			
					Edge Distances = c_{ac} on all sides		Edge Distances = c_{min} on one side and c_{ac} on three sides	
					Uncracked	Cracked	Uncracked	Cracked
1/4	1 5/8	3 1/4	3	1 1/2	760	430	395	380
	2 1/2	3 1/2	6	1 1/2	1,265	745	395	580
3/8	2 1/2	4	2 1/16	1 3/4	1,055	485	810	485
	3 1/4	5	3 3/8	1 3/4	1,740	1,055	1,085	775
1/2	3 1/4	5	3 9/16	1 3/4	1,685	1,195	1,060	760
	4	6 1/4	4 1/2	1 3/4	2,420	1,715	1,370	970
5/8	4	6	4 1/2	1 3/4	2,395	1,185	1,350	965
	5 1/2	8 1/2	6 3/8	1 3/4	3,825	2,170	2,035	1,445
3/4	5 1/2	8 3/4	6 3/8	1 3/4	4,055	2,365	2,015	1,435
	6 1/4	10	7 5/16	1 3/4	5,015	2,805	2,395	1,700

1. Allowable tension loads are calculated based on the strength design provision of ACI 318-11 Appendix D using a conversion factor of $\alpha = 1.67$. The conversion factor α is based on the load combination assuming 100% wind load.
2. Tabulated values are for a single anchor with no influence of another anchor.
3. Interpolation between embedment depths is not permitted.

* See page 12 for an explanation of the load table icons.

Titen HD® Design Information — Concrete

Titen HD® Allowable Tension Loads in Normal-Weight Concrete
($f'_c = 2,500$ psi) — Seismic Load

Anchor Dia. (in.)	Nominal Embed. Depth (in.)	Min. Concrete Thickness h_{min} (in.)	Critical Edge Distance c_{ac} (in.)	Minimum Edge Distance c_{min} (in.)	Allowable Tension Load (lb.)							
					Edge Distances = c_{ac} on all sides				Edge Distances = c_{min} on one side and c_{ac} on three sides			
					SDC A-B ⁴		SDC C-F ^{5,6}		SDC A-B ⁴		SDC C-F ^{5,6}	
					Uncracked	Cracked	Uncracked	Cracked	Uncracked	Cracked	Uncracked	Cracked
1/4	1 5/8	3 1/4	3	1 1/2	885	500	665	380	460	440	345	330
	2 1/2	3 1/2	6	1 1/2	1,475	870	1,105	650	460	675	345	510
3/8	2 1/2	4	2 11/16	1 3/4	1,230	565	920	420	945	565	710	420
	3 1/4	5	3 5/8	1 3/4	2,030	1,230	1,525	920	1,265	905	950	680
1/2	3 1/4	5	3 3/16	1 3/4	1,965	1,395	1,475	1,045	1,235	885	930	665
	4	6 1/4	4 1/2	1 3/4	2,825	2,000	2,120	1,500	1,600	1,135	1,195	855
5/8	4	6	4 1/2	1 3/4	2,795	1,385	2,095	1,035	1,575	1,125	1,185	845
	5 1/2	8 1/2	6 3/8	1 3/4	4,465	2,535	3,345	1,900	2,375	1,685	1,780	1,265
3/4	5 1/2	8 3/4	6 3/8	1 3/4	4,730	2,760	3,550	2,070	2,350	1,675	1,760	1,255
	6 1/4	10	7 5/16	1 3/4	5,850	3,275	4,385	2,455	2,795	1,985	2,095	1,490

1. Allowable tension loads are calculated based on the strength design provision of ACI 318-11 Appendix D using a conversion factor of $\alpha = 1/0.7 = 1.43$. The conversion factor α is based on the load combination assuming 100% seismic load.

2. Tabulated values are for a single anchor with no influence of another anchor.

3. Interpolation between embedment depths is not permitted.

4. The allowable tension load listed for SDC (Seismic Design Category) A-B may also be used in SDC C-F when the tension component of the strength-level seismic design load on the anchor does not exceed 20% of the total factored tension load on the anchor associated with the same load combination.

5. When designing anchorages in SDC C-F, the designer shall consider the ductility requirements of ACI 318-11 Section D.3.3.

6. Tension design strengths in SDC C-F have been adjusted by 0.75 factor in accordance with ACI 318-11 Section D.3.3.4.4.

Titen HD® Design Information — Concrete

Titen HD® Tension Design Strengths in Soffit of Normal-Weight or Sand-Lightweight Concrete-Filled Profile Steel Deck Assemblies ($f'_c = 3,000$ psi)



Anchor Dia. (in.)	Nominal Embed. Depth (in.)	Minimum End Distance c_{min} (in.)	Tension Design Strength (lb.)							
			Lower Flute				Upper Flute			
			SDC A-B ⁵		SDC C-F ^{6,7}		SDC A-B ⁵		SDC C-F ^{6,7}	
Uncracked	Cracked	Uncracked	Cracked	Uncracked	Cracked	Uncracked	Cracked			
1/4	1 5/8	2 1/2	645	275	485	205	1,010	425	760	320
	2 1/2	4	830	350	620	260	1,855	775	1,390	585
3/8	1 7/8	2 1/2	535	245	400	185	710	325	535	245
	2 1/2	3 5/8	1,240	565	930	425	—	—	—	—
1/2	2	2 5/8	840	590	630	440	1,580	1,105	1,185	830
	3 1/2	5 1/4	1,890	1,325	1,420	995	—	—	—	—

1. Tension design strengths are based on the strength design provisions of ACI 318-11 Appendix D.
2. Tabulated values are for a single anchor with no influence of another anchor.
3. Interpolation between embedment depths is not permitted.
4. Strength reduction factor, ϕ , is based on using a load combination from ACI 318-11 Section 9.2.
5. The tension design strength listed for SDC (Seismic Design Category) A-B may also be used in SDC C-F when the tension component of the strength-level seismic design load on the anchor does not exceed 20% of the total factored tension load on the anchor associated with the same load combination.
6. When designing anchorages in SDC C-F, the designer shall consider the ductility requirements of ACI 318-11 Section D.3.3.
7. Tension design strengths in SDC C-F have been adjusted by 0.75 factor in accordance with ACI 318-11 Section D.3.3.4.4.
8. Installation must comply with Figure 1 on page 187.

Titen HD® Allowable Tension Loads in Soffit of Normal-Weight or Sand-Lightweight Concrete-Filled Profile Steel Deck Assemblies ($f'_c = 3,000$ psi) — Static Load



Anchor Dia. (in.)	Nominal Embed. Depth (in.)	Minimum End Distance c_{min} (in.)	Allowable Tension Load (lb.)			
			Lower Flute		Upper Flute	
			Uncracked	Cracked	Uncracked	Cracked
1/4	1 5/8	2 1/2	460	195	720	305
	2 1/2	4	595	250	1,325	555
3/8	1 7/8	2 1/2	380	175	505	230
	2 1/2	3 5/8	885	405	—	—
1/2	2	2 5/8	600	420	1,130	790
	3 1/2	5 1/4	1,350	945	—	—

1. Allowable tension loads are calculated based on the strength design provision of ACI 318-11 Appendix D using a conversion factor of $\alpha = 1.4$. The conversion factor α is based on the load combination 1.2D + 1.6L assuming 50% dead load and 50% live load: $1.2(0.5) + 1.6(0.5) = 1.4$.
2. Tabulated values are for a single anchor with no influence of another anchor.
3. Interpolation between embedment depths is not permitted.
4. Installation must comply with Figure 1 on page 187.

Titen HD® Allowable Tension Loads in Soffit of Normal-Weight or Sand-Lightweight Concrete-Filled Profile Steel Deck Assemblies ($f'_c = 3,000$ psi) — Wind Load



Anchor Dia. (in.)	Nominal Embed. Depth (in.)	Minimum End Distance c_{min} (in.)	Allowable Tension Load (lb.)			
			Lower Flute		Upper Flute	
			Uncracked	Cracked	Uncracked	Cracked
1/4	1 5/8	2 1/2	385	165	605	255
	2 1/2	4	500	210	1,115	465
3/8	1 7/8	2 1/2	320	145	425	195
	2 1/2	3 5/8	745	340	—	—
1/2	2	2 5/8	505	355	950	665
	3 1/2	5 1/4	1,135	795	—	—

1. Allowable tension loads are calculated based on the strength design provision of ACI 318-11 Appendix D using a conversion factor of $\alpha = 1.67$. The conversion factor α is based on the load combination assuming 100% wind load.
2. Tabulated values are for a single anchor with no influence of another anchor.
3. Interpolation between embedment depths is not permitted.
4. Installation must comply with Figure 1 on page 187.

* See page 12 for an explanation of the load table icons.

Titen HD® Design Information — Concrete

Titen HD® Allowable Tension Loads in Soffit of Normal-Weight or Sand-Lightweight Concrete-Filled Profile Steel Deck Assemblies ($f'_c = 3,000$ psi) — Seismic Load

Anchor Dia. (in.)	Nominal Embed. Depth (in.)	Minimum End Distance C_{min} (in.)	Allowable Tension Load (lb.)							
			Lower Flute				Upper Flute			
			SDC A-B ⁴		SDC C-F ^{5,6}		SDC A-B ⁴		SDC C-F ^{5,6}	
Uncracked	Cracked	Uncracked	Cracked	Uncracked	Cracked	Uncracked	Cracked			
¼	1 ⅝	2 ½	450	195	340	145	705	300	530	225
	2 ½	4	580	245	435	180	1300	545	975	410
⅜	1 ⅞	2 ½	375	170	280	130	495	230	375	170
	2 ½	3 ⅝	870	395	650	300	—	—	—	—
½	2	2 ⅝	590	415	440	310	1105	775	830	580
	3 ½	5 ¼	1325	930	995	695	—	—	—	—

1. Allowable tension loads are calculated based on the strength design provision of ACI 318-11 Appendix D using a conversion factor of $\alpha = 1/0.7 = 1.43$. The conversion factor α is based on the load combination assuming 100% seismic load.
2. Tabulated values are for a single anchor with no influence of another anchor.
3. Interpolation between embedment depths is not permitted.
4. The allowable tension load listed for SDC (Seismic Design Category) A-B may also be used in SDC C-F when the tension component of the strength-level seismic design load on the anchor does not exceed 20% of the total factored tension load on the anchor associated with the same load combination.
5. When designing anchorages in SDC C-F, the designer shall consider the ductility requirements of ACI 318-11 Section D.3.3.
6. Tension design strengths in SDC C-F have been adjusted by 0.75 factor in accordance with ACI 318-11 Section D.3.3.4.4.
7. Installation must comply with Figure 1 on page 187.

* See page 12 for an explanation of the load table icons.

Titen HD® Design Information — Concrete



Titen HD® Allowable Tension Loads in Normal-Weight Concrete

Mechanical Anchors

Size (in.)	Drill Bit Dia. (in.)	Embed. Depth in. (mm)	Critical Edge Dist. in. (mm)	Critical Spacing in. (mm)	Tension Load						
					f' _c ≥ 2,000 psi (13.8 MPa Concrete)			f' _c ≥ 3,000 psi (20.7 MPa Concrete)		f' _c ≥ 4,000 psi (27.6 MPa Concrete)	
					Ultimate lb. (kN)	Std. Dev. lb. (kN)	Allowable lb. (kN)	Allowable lb. (kN)	Ultimate lb. (kN)	Std. Dev. lb. (kN)	Allowable lb. (kN)
3/8 (9.5)	3/8	1 1/2 (38)	6 (152)	4 (102)	2,070 (9.2)	—	520 (2.3)	635 (2.8)	2,974 (13.2)	—	745 (3.3)
		2 3/4 (70)	3 (76)	6 (152)	4,297 (19.1)	—	1,075 (4.8)	1,315 (5.8)	6,204 (27.6)	—	1,550 (6.9)
		3 3/4 (95)			7,087 (31.5)	347 (1.5)	1,770 (7.9)	2,115 (9.4)	9,820 (43.7)	1,434 (6.4)	2,455 (10.9)
1/2 (12.7)	1/2	2 3/4 (70)	4 (102)	8 (203)	4,610 (20.5)	—	1,155 (5.1)	1,400 (6.2)	6,580 (29.3)	—	1,645 (7.3)
		3 3/8 (92)			7,413 (33.0)	412 (1.8)	1,855 (8.3)	2,270 (10.1)	10,742 (47.8)	600 (2.7)	2,685 (11.9)
		5 3/4 (146)			10,278 (45.7)	297 (1.3)	2,570 (11.4)	3,240 (14.4)	15,640 (69.6)	2,341 (10.4)	3,910 (17.4)
5/8 (15.9)	5/8	2 3/4 (70)	5 (127)	10 (254)	4,610 (20.5)	—	1,155 (5.1)	1,400 (6.2)	6,580 (29.3)	—	1,645 (7.3)
		4 1/8 (105)			8,742 (38.9)	615 (2.7)	2,185 (9.7)	2,630 (11.7)	12,286 (54.7)	1,604 (7.1)	3,070 (13.7)
		5 3/4 (146)			12,953 (57.6)	1,764 (7.8)	3,240 (14.4)	3,955 (17.6)	18,680 (83.1)	—	4,670 (20.8)
3/4 (19.1)	3/4	2 3/4 (70)	6 (152)	12 (305)	4,674 (20.8)	—	1,170 (5.2)	1,405 (6.3)	6,580 (29.3)	—	1,645 (7.3)
		4 5/8 (117)			10,340 (46.0)	1,096 (4.9)	2,585 (11.5)	3,470 (15.4)	17,426 (77.5)	1,591 (7.1)	4,355 (19.4)
		5 3/4 (146)			13,765 (61.2)	1,016 (4.5)	3,440 (15.3)	4,055 (18.0)	18,680 (83.1)	1,743 (7.8)	4,670 (20.8)

- The allowable loads listed are based on a safety factor of 4.0.
- Refer to allowable load-adjustment factors for spacing and edge distance on pages 198 and 199.
- The minimum concrete thickness is 1 1/2 times the embedment depth.
- Tension and shear loads for the Titen HD anchor may be combined using the elliptical interaction equation (n=5/6). Allowable load may be interpolated for concrete compressive strengths between 2,000 psi and 4,000 psi.



Titen HD® Allowable Shear Loads in Normal-Weight Concrete

Size (in.)	Drill Bit Dia. (in.)	Embed. Depth in. (mm)	Critical Edge Dist. in. (mm)	Critical Spacing in. (mm)	Shear Load						
					f' _c ≥ 2,000 psi (13.8 MPa Concrete)			f' _c ≥ 3,000 psi (20.7 MPa Concrete)		f' _c ≥ 4,000 psi (27.6 MPa Concrete)	
					Ultimate lb. (kN)	Std. Dev. lb. (kN)	Allowable lb. (kN)	Allowable lb. (kN)	Ultimate lb. (kN)	Std. Dev. lb. (kN)	Allowable lb. (kN)
3/8 (9.5)	3/8	1 1/2 (38)	6 (152)	4 (102)	2,912 (13.0)	—	730 (3.2)	825 (3.7)	3,668 (16.3)	—	915 (4.1)
		2 3/4 (70)	4 1/2 (114)	6 (152)	6,353 (28.3)	—	1,585 (7.1)	1,665 (7.4)	—	—	1,740 (7.7)
		3 3/4 (95)			6,377 (28.4)	1,006 (4.5)	1,595 (7.1)	1,670 (7.4)	—	1,740 (7.7)	
1/2 (12.7)	1/2	2 3/4 (70)	6 (152)	8 (203)	6,435 (28.6)	—	1,605 (7.1)	2,050 (9.1)	9,987 (44.4)	—	2,495 (7.8)
		3 3/8 (92)			9,324 (41.5)	1,285 (5.7)	2,330 (10.4)	2,795 (12.4)	13,027 (57.9)	597 (2.7)	3,255 (14.5)
		5 3/4 (146)			11,319 (50.3)	1,245 (5.5)	2,830 (12.6)	3,045 (13.5)	—	—	3,255 (14.5)
5/8 (15.9)	5/8	2 3/4 (70)	7 1/2 (191)	10 (254)	7,745 (34.5)	—	1,940 (8.6)	2,220 (9.9)	9,987 (44.4)	—	2,495 (7.8)
		4 1/8 (105)			8,706 (38.7)	1,830 (8.1)	2,175 (9.7)	3,415 (15.2)	18,607 (82.8)	1,650 (7.3)	4,650 (20.7)
		5 3/4 (146)			12,498 (55.6)	2,227 (9.9)	3,125 (13.9)	3,890 (17.3)	—	—	4,650 (20.7)
3/4 (19.1)	3/4	2 3/4 (70)	9 (229)	12 (305)	7,832 (34.8)	—	1,960 (8.7)	2,415 (10.7)	11,460 (51.0)	—	2,865 (12.7)
		4 5/8 (117)			11,222 (49.9)	2,900 (12.9)	2,805 (12.5)	4,490 (20.0)	24,680 (109.8)	2,368 (10.5)	6,170 (27.4)
		5 3/4 (146)			19,793 (88.0)	3,547 (15.8)	4,950 (22.0)	5,560 (24.7)	24,680 (109.8)	795 (3.5)	6,170 (27.4)

- The allowable loads listed are based on a safety factor of 4.0.
- Refer to allowable load-adjustment factors for spacing and edge distance on pages 198 and 199.
- The minimum concrete thickness is 1 1/2 times the embedment depth.
- Tension and shear loads for the Titen HD anchor may be combined using the elliptical interaction equation (n=5/6). Allowable load may be interpolated for concrete compressive strengths between 2,000 psi and 4,000 psi.

* See page 12 for an explanation of the load table icons.

Titen HD® Design Information — Concrete

Titen HD® Allowable Shear Loads in Normal-Weight Concrete, Load Applied Parallel to Concrete Edge   *

Size in. (mm)	Drill Bit Dia. in.	Embed. Depth in. (mm)	Minimum Edge Dist. in. (mm)	Minimum End Dist. in. (mm)	Minimum Spacing Dist. in. (mm)	Shear Load Based on Concrete Edge Distance		
						$f'_c \geq 2,500$ psi (17.2 MPa) Concrete		
						Ultimate lb. (kN)	Std. Dev. lb. (kN)	Allowable lb. (kN)
1/2 (12.7)	1/2	2 3/4 (70)	1 3/4 (45)	8 (203)	8 (203)	4,660 (20.7)	575 (2.6)	1,165 (5.2)
		3 1/4 (83)				—	1,530 (6.8)	
		3 1/2 (89)				6,840 (30.4)	860 (3.8)	1,710 (7.6)
		4 1/2 (114)				7,800 (34.7)	300 (1.3)	1,950 (8.7)
5/8 (15.9)	5/8	2 3/4 (70)	1 3/4 (45)	10 (254)	10 (254)	4,820 (21.4)	585 (2.6)	1,205 (5.3)
		3 1/4 (83)				—	1,580 (7.0)	
		3 1/2 (89)				7,060 (31.4)	1,284 (5.7)	1,765 (7.9)

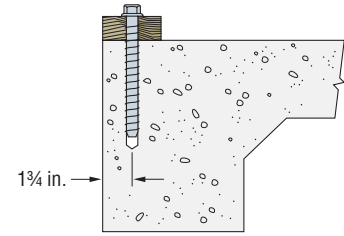

Note: Rebar not shown for clarity.

1. The allowable loads listed are based on a safety factor of 4.0.
2. The minimum concrete thickness is 1 1/2 times the embedment depth.

Titen HD® Allowable Tension Loads in Normal-Weight Concrete Stemwall   *

Size in. (mm)	Drill Bit Dia. in.	Embed. Depth in. (mm)	Stemwall Width in. (mm)	Min. Edge Dist. in. (mm)	Min. End Dist. in. (mm)	Tension Load			
						$f'_c \geq 2,500$ psi (17.2 MPa) Concrete		$f'_c \geq 4,500$ psi (31.0 MPa) Concrete	
						Ultimate lb. (kN)	Allow. lb. (kN)	Ultimate lb. (kN)	Allow. lb. (kN)
1/2 (12.7)	1/2	10 (254)	6 (152)	1 3/4 (45)	8 (203)	15,420 (68.6)	3,855 (17.1)	20,300 (90.3)	5,075 (22.6)
					4 3/8 (111)	14,280 (63.5)	3,570 (15.9)	19,040 (84.7)	4,760 (21.2)

1. The allowable loads are based on a safety factor of 4.0.
2. The minimum anchor spacing is 15 inches.
3. The minimum concrete thickness (depth) is 12 inches.
4. Allowable loads may be interpolated for compressive strengths between 2,500 and 4,500 psi.

Titen HD® Allowable Tension Loads in Normal-Weight Concrete, Load Applied at 60° Angle to Horizontal for Tilt-Up Wall Braces   *

Size in. (mm)	Drill Bit Dia. in.	Embed. Depth in. (mm)	Tension Applied at 60 degrees to Horizontal		
			$f'_c \geq 2,500$ psi (17.2 MPa) Concrete		
			Ultimate lb. (kN)	Std. Dev. lb. (kN)	Allow. lb. (kN)
5/8 (15.9)	5/8	5 (127)	13,420 (59.7)	1,273 (5.7)	3,355 (14.9)
3/4 (19.1)	3/4	5 (127)	15,180 (67.5)	968 (4.3)	3,795 (16.9)

1. The allowable loads are based on a safety factor of 4.0.
2. Anchor must be installed into a concrete floor slab, footing, or deadman with sufficient area, weight, and strength to resist the anchorage load.
3. Titen HD® has been qualified for temporary outdoor use of up to 90 days through testing for this application.



The Titen HD® screw anchor 3/4" x 6" and 3/4" x 7" (models THDT75600H and THD75700H) have a 1" section under the head that is unthreaded to allow installation into tilt-up wall braces.

* See page 12 for an explanation of the load table icons.

Titen HD® Design Information — Concrete



Titen HD® Allowable Tension and Shear Loads in Sand-Lightweight Concrete over Metal Deck

Mechanical Anchors

Size in. (mm)	Drill Bit Dia. in.	Embed. Depth in. (mm)	Critical Edge Dist. in. (mm)	Critical Spacing Dist. in. (mm)	Install in Concrete (see Figure below)				Install through Metal Deck (see Figure below)			
					Tension Load		Shear Load		Tension Load		Shear Load	
					$f'_c \geq 3,000$ psi (20.7 MPa) Lightweight Concrete		$f'_c \geq 3,000$ psi (20.7 MPa) Lightweight Concrete		$f'_c \geq 3,000$ psi (20.7 MPa) Lightweight Concrete		$f'_c \geq 3,000$ psi (20.7 MPa) Lightweight Concrete	
					Ultimate lb. (kN)	Allowable lb. (kN)	Ultimate lb. (kN)	Allowable lb. (kN)	Ultimate lb. (kN)	Allowable lbs. (kN)	Ultimate lb. (kN)	Allowable lb. (kN)
3/8 (9.5)	3/8	2 3/4 (70)	6 (152)	6 (152)	2,560 (11.4)	640 (2.8)	4,240 (18.9)	1,060 (4.7)	—	—	—	—
		3 (76)			—	—	—	—	5,420 (24.1)	1,355 (6.0)	4,100 (18.2)	1,025 (4.6)
1/2 (12.7)	1/2	2 3/4 (70)	8 (203)	8 (203)	3,040 (13.5)	760 (3.4)	6,380 (28.4)	1,595 (7.1)	—	—	—	—
		4 (102)			—	—	—	7,020 (31.2)	1,755 (7.8)	6,840 (30.4)	1,710 (7.6)	
5/8 (15.9)	5/8	2 3/4 (70)	10 (254)	10 (254)	3,100 (13.8)	775 (3.4)	6,380 (28.4)	1,595 (7.1)	—	—	—	—
		5 (127)			—	—	—	8,940 (39.8)	2,235 (9.9)	10,700 (47.6)	2,675 (11.9)	

- The allowable loads listed are based on a safety factor of 4.0.
- Allowable loads for anchors installed in the lower flute of the steel deck are for flutes with a trapezoidal profile with a depth of 3 inches, and a width varying from 4 1/2 inches at the bottom to 7 1/2 inches at the top. The spacing of the flutes is 12 inches. The metal deck must be minimum 20-gauge with a minimum yield strength of 38 ksi and minimum ultimate strength of 45 ksi.
- Anchors may be installed off-center in the lower flute (up to 1 1/2" from the edge of the lower flute) without a load reduction.
- 100% of the allowable load is permitted at critical edge distance and critical spacing. Testing at smaller edge distances and spacings has not been performed.

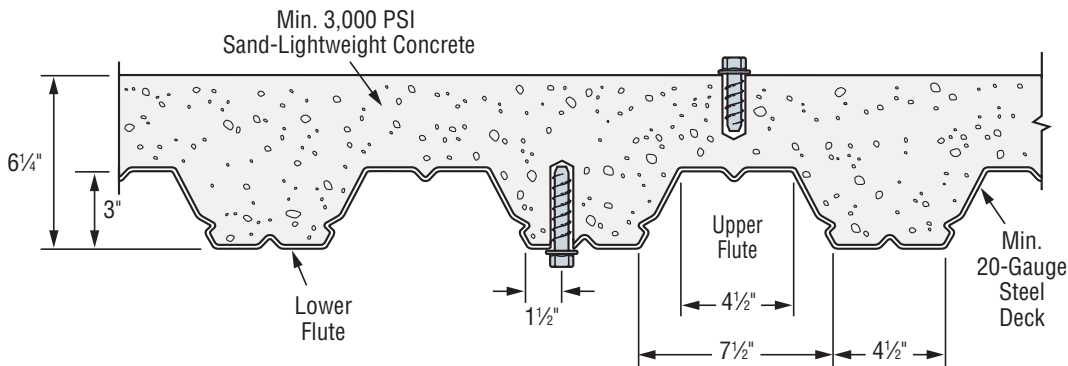

Titen HD® screw anchor installed in the top and bottom of a structural sand-lightweight-concrete and metal-deck assembly

* See page 12 for an explanation of the load table icons.

Titen HD® Design Information — Masonry

Titen HD® Allowable Tension and Shear Loads in 8" Lightweight, Medium-Weight and Normal-Weight Grout-Filled CMU



Size in. (mm)	Drill Bit Dia. in.	Min. Embed. Depth in. (mm)	Critical Edge Dist. in. (mm)	Critical End Dist. in. (mm)	Critical Spacing Dist. in. (mm)	Values for 8-inch Lightweight, Medium-Weight or Normal-Weight Grout-Filled CMU			
						Tension Load		Shear Load	
						Ultimate lb. (kN)	Allowable lb. (kN)	Ultimate lb. (kN)	Allowable lb. (kN)
Anchor Installed in the Face of the CMU Wall (See Figure 4)									
3/8 (9.5)	3/8	2 3/4 (70)	12 (305)	12 (305)	6 (152)	2,390 (10.6)	480 (2.1)	4,340 (19.3)	870 (3.9)
1/2 (12.7)	1/2	3 1/2 (89)	12 (305)	12 (305)	8 (203)	3,440 (15.3)	690 (3.1)	6,920 (30.8)	1,385 (6.2)
5/8 (15.9)	5/8	4 1/2 (114)	12 (305)	12 (305)	10 (254)	5,300 (23.6)	1,060 (4.7)	10,420 (46.4)	2,085 (9.3)
3/4 (19.1)	3/4	5 1/2 (140)	12 (305)	12 (305)	12 (305)	7,990 (35.5)	1,600 (7.1)	15,000 (66.7)	3,000 (13.3)

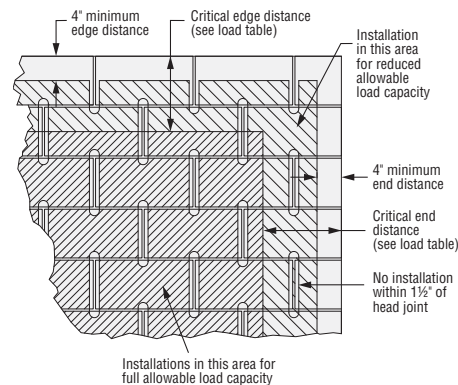

Figure 4. Shaded Area = Placement for Full and Reduced Allowable Load Capacity in Grout-Filled CMU

1. The tabulated allowable loads are based on a safety factor of 5.0 for installations under the IBC and IRC.
2. Values for 8-inch-wide, lightweight, medium-weight and normal-weight concrete masonry units.
3. The masonry units must be fully grouted.
4. The minimum specified compressive strength of masonry, f'_m , at 28 days is 1,500 psi.
5. Embedment depth is measured from the outside face of the concrete masonry unit.
6. Allowable loads may be increased 33 1/3% for short-term loading due to wind or seismic forces where permitted by code.
7. Grout-filled CMU wall design must satisfy applicable design standards and be capable of withstanding applied loads.
8. Refer to allowable load-adjustment factors for spacing and edge distance on page 200.

Titen HD® Allowable Tension and Shear Loads in 8" Lightweight, Medium-Weight and Normal-Weight Hollow CMU



Size in. (mm)	Drill Bit Dia. in.	Embed. Depth ⁴ in. (mm)	Min. Edge Dist. in. (mm)	Min. End Dist. in. (mm)	8-inch Hollow CMU Loads Based on CMU Strength			
					Tension Load		Shear Load	
					Ultimate lb. (kN)	Allowable lb. (kN)	Ultimate lb. (kN)	Allowable lb. (kN)
Anchor Installed in Face Shell (See Figure 5)								
3/8 (9.5)	3/8	1 3/4 (45)	4 (102)	4 5/8 (117)	720 (3.2)	145 (0.6)	1,240 (5.5)	250 (1.1)
1/2 (12.7)	1/2	1 3/4 (45)	4 (102)	4 5/8 (117)	760 (3.4)	150 (0.7)	1,240 (5.5)	250 (1.1)
5/8 (15.9)	5/8	1 3/4 (45)	4 (102)	4 5/8 (117)	800 (3.6)	160 (0.7)	1,240 (5.5)	250 (1.1)
3/4 (19.1)	3/4	1 3/4 (45)	4 (102)	4 5/8 (117)	880 (3.9)	175 (0.8)	1,240 (5.5)	250 (1.1)

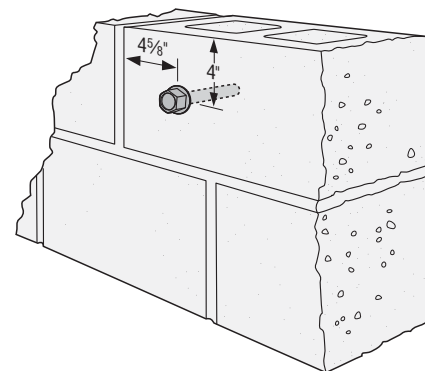

Figure 5

1. The tabulated allowable loads are based on a safety factor of 5.0 for installations under the IBC and IRC.
2. Values for 8-inch-wide, lightweight, medium-weight and normal-weight concrete masonry units.
3. The minimum specified compressive strength of masonry, f'_m , at 28 days is 1,500 psi.
4. Embedment depth is measured from the outside face of the concrete masonry unit and is based on the anchor being embedded an additional 1/2" through 1 1/4" thick face shell.
5. Allowable loads may not be increased for short-term loading due to wind or seismic forces. CMU wall design must satisfy applicable design standards and be capable of withstanding applied loads.
6. Do not use impact wrenches to install in hollow CMU.
7. Set drill to rotation-only mode when drilling into hollow CMU.

* See page 12 for an explanation of the load table icons.

Titen HD® Design Information — Masonry

Titen HD® Allowable Tension and Shear Loads in 8" Lightweight, Medium-Weight and Normal-Weight Grout-Filled CMU Stemwall



Size in. (mm)	Drill Bit Dia. in.	Embed. Depth in. (mm)	Min. Edge Dist. in. (mm)	Min. End Dist. in. (mm)	Critical Spacing Dist. in. (mm)	8-inch Grout-Filled CMU Allowable Loads Based on CMU Strength					
						Tension		Shear Perp. to Edge		Shear Parallel to Edge	
						Ultimate lb. (kN)	Allowable lb. (kN)	Ultimate lb. (kN)	Allowable lb. (kN)	Ultimate lb. (kN)	Allowable lb. (kN)
Anchor Installed in Cell Opening or Web (Top of Wall) (See Figure 6)											
½ (12.7)	½	4½ (114)	1¼ (45)	8 (203)	8 (203)	2,860 (12.7)	570 (2.5)	800 (3.6)	160 (0.7)	2,920 (13.0)	585 (2.6)
⅝ (15.9)	⅝	4½ (114)	1¼ (45)	10 (254)	10 (254)	2,860 (12.7)	570 (2.5)	800 (3.6)	160 (0.7)	3,380 (15.0)	675 (3.0)

1. The tabulated allowable loads are based on a safety factor of 5.0 for installations under the IBC and IRC.
2. Values are for 8-inch-wide, lightweight, medium-weight and normal-weight concrete masonry units.
3. The masonry units must be fully grouted.
4. The minimum specified compressive strength of masonry, f'_m , at 28 days is 1,500 psi.
5. Allowable loads may be increased 33⅓% for short-term loading due to wind or seismic forces where permitted by code.
6. Grout-filled CMU wall design must satisfy applicable design standards and be capable of withstanding applied design loads.
7. Loads are based on anchor installed in either the web or grout-filled cell opening in the top of wall.

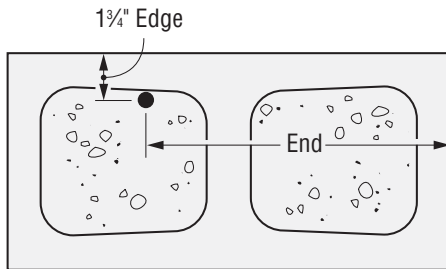

Figure 6. Anchor Installed in top of wall

* See page 12 for an explanation of the load table icons.

Titen HD® Design Information — Masonry

Titen HD® Allowable Tension Loads for 8" Lightweight, Medium-Weight and Normal-Weight CMU Chair Blocks Filled with Normal-Weight Concrete



Size in. (mm)	Drill Bit Dia. (in.)	Min. Embed. Depth in. (mm)	Min. Edge Dist. in. (mm)	Critical Spacing in. (mm)	8-inch Concrete-Filled CMU Chair Block Allowable Tension Loads Based on CMU Strength	
					Ultimate lb. (kN)	Allowable lb. (kN)
3/8 (9.5)	3/8	2 3/8 (60)	1 3/4 (44)	9 1/2 (241)	3,175 (14.1)	635 (2.8)
		3 3/8 (86)	1 3/4 (44)	13 1/2 (343)	5,175 (23.0)	1,035 (4.6)
		5 (127)	2 1/4 (57)	20 (508)	10,584 (47.1)	2,115 (9.4)
1/2 (12.7)	1/2	8 (203)	2 1/4 (57)	32 (813)	13,722 (61.0)	2,754 (12.2)
		10 (254)	2 1/4 (57)	40 (1016)	16,630 (74.0)	3,325 (14.8)
5/8 (15.9)	5/8	5 1/2 (140)	1 3/4 (44)	22 (559)	9,025 (40.1)	1,805 (8.1)
		12 (305)	2 1/4 (57)	48 (1219)	18,104 (80.5)	3,620 (16.1)

1. The tabulated allowable loads are based on a safety factor of 5.0.
2. Values are for 8-inch-wide concrete masonry units (CMU) filled with concrete, with minimum compressive strength of 2,500 psi and poured monolithically with the floor slab.
3. Center #5 rebar in CMU cell and concrete slab as shown in the illustration below.

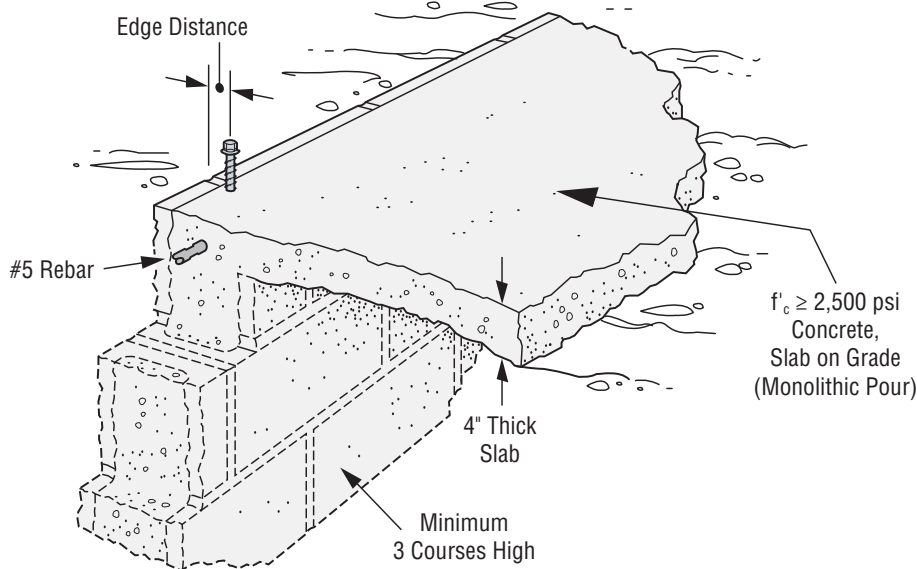

* See page 12 for an explanation of the load table icons.

Titen HD® Design Information — Concrete

Load Adjustment Factors for Titen HD® Anchors in Normal-Weight Concrete:
Edge Distance, Tension and Shear Loads

How to use these charts:

1. The following tables are for reduced edge distance.
2. Locate the anchor size to be used for either a tension and/or shear load application.
3. Locate the anchor embedment (E) used for either a tension and/or shear load application.
4. Locate the edge distance (c_{act}) at which the anchor is to be installed.
5. The load adjustment factor (f_c) is the intersection of the row and column.
6. Multiply the allowable load by the applicable load adjustment factor(s).
7. Reduction factors for multiple edges are multiplied together.

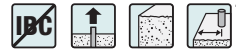

Edge Distance Tension (f_c)

Edge Dist. c_{act} (in.)	Dia.		3/8			1/2			5/8			3/4		
	E	1 1/2	2 3/4	3 3/4	2 3/4	3 3/8	5 3/4	2 3/4	4 1/8	5 3/4	2 3/4	4 3/8	5 3/4	
	c_{cr}	6	3	3	4	4	4	5	5	5	6	6	6	
	c_{min}	6	1 3/4	1 3/4	1 3/4	1 3/4	1 3/4	1 3/4	1 3/4	1 3/4	1 3/4	1 3/4	1 3/4	
	f_{cmin}	1.00	0.83	0.73	0.67	0.57	0.73	0.67	0.57	0.59	0.67	0.48	0.58	
1 3/4			0.83	0.73	0.67	0.57	0.73	0.67	0.57	0.59	0.67	0.48	0.58	
2			0.86	0.78	0.71	0.62	0.76	0.70	0.60	0.62	0.69	0.51	0.60	
2 1/4			0.90	0.84	0.74	0.67	0.79	0.72	0.64	0.65	0.71	0.54	0.63	
2 1/2			0.93	0.89	0.78	0.71	0.82	0.75	0.67	0.68	0.73	0.57	0.65	
2 3/4			0.97	0.95	0.82	0.76	0.85	0.77	0.70	0.72	0.75	0.60	0.68	
3			1.00	1.00	0.85	0.81	0.88	0.80	0.74	0.75	0.77	0.63	0.70	
3 1/4					0.89	0.86	0.91	0.82	0.77	0.78	0.79	0.66	0.73	
3 1/2					0.93	0.90	0.94	0.85	0.80	0.81	0.81	0.69	0.75	
3 3/4					0.96	0.95	0.97	0.87	0.83	0.84	0.83	0.72	0.78	
4					1.00	1.00	1.00	0.90	0.87	0.87	0.84	0.76	0.80	
4 1/4								0.92	0.90	0.91	0.86	0.79	0.83	
4 1/2								0.95	0.93	0.94	0.88	0.82	0.85	
4 3/4								0.97	0.97	0.97	0.90	0.85	0.88	
5								1.00	1.00	1.00	0.92	0.88	0.90	
5 1/4											0.94	0.91	0.93	
5 1/2											0.96	0.94	0.95	
5 3/4											0.98	0.97	0.98	
6		1.00									1.00	1.00	1.00	

See notes below.

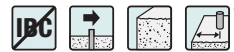

Edge Distance Shear (f_c)

Edge Dist. c_{act} (in.)	Dia.		3/8			1/2			5/8			3/4		
	E	1 1/2	2 3/4	3 3/4	2 3/4	3 3/8	5 3/4	2 3/4	4 1/8	5 3/4	2 3/4	4 3/8	5 3/4	
	c_{cr}	6	4 1/2	4 1/2	6	6	6	7 1/2	7 1/2	7 1/2	9	9	9	
	c_{min}	6	1 3/4	1 3/4	1 3/4	1 3/4	1 3/4	1 3/4	1 3/4	1 3/4	1 3/4	1 3/4	1 3/4	
	f_{cmin}	1.00	0.25	0.24	0.25	0.20	0.17	0.19	0.16	0.19	0.19	0.14	0.13	
1 3/4			0.25	0.24	0.25	0.20	0.17	0.19	0.16	0.19	0.19	0.14	0.13	
2			0.32	0.31	0.29	0.25	0.22	0.23	0.20	0.23	0.22	0.17	0.16	
2 1/2			0.45	0.45	0.38	0.34	0.32	0.30	0.27	0.30	0.27	0.23	0.22	
3			0.59	0.59	0.47	0.44	0.41	0.37	0.34	0.37	0.33	0.29	0.28	
3 1/2			0.73	0.72	0.56	0.53	0.51	0.44	0.42	0.44	0.39	0.35	0.34	
4			0.86	0.86	0.65	0.62	0.61	0.51	0.49	0.51	0.44	0.41	0.40	
4 1/2			1.00	1.00	0.74	0.72	0.71	0.58	0.56	0.58	0.50	0.47	0.46	
5					0.82	0.81	0.80	0.65	0.63	0.65	0.55	0.53	0.52	
5 1/2					0.91	0.91	0.90	0.72	0.71	0.72	0.61	0.58	0.58	
6		1.00			1.00	1.00	1.00	0.79	0.78	0.79	0.66	0.64	0.64	
6 1/2								0.86	0.85	0.86	0.72	0.70	0.70	
7								0.93	0.93	0.93	0.78	0.76	0.76	
7 1/2								1.00	1.00	1.00	0.83	0.82	0.82	
8											0.89	0.88	0.88	
8 1/2											0.94	0.94	0.94	
9											1.00	1.00	1.00	

The tabled adjustment values (f_c) have been calculated using the following information:

1. E = Embedment depth (inches).
2. c_{act} = actual edge distance at which anchor is installed (inches).
3. c_{cr} = critical edge distance for 100% load (inches).
4. c_{min} = minimum edge distance for reduced load (inches).
5. f_c = percent of allowable load at actual edge distance.
6. $f_{c_{cr}}$ = percentage of allowable load at critical edge distance. $f_{c_{cr}}$ is always = 1.00.
7. $f_{c_{min}}$ = percent of allowable load at minimum edge distance.
8. $f_c = f_{c_{min}} + [(1 - f_{c_{min}}) (c_{act} - c_{min}) / (c_{cr} - c_{min})]$.

* See page 12 for an explanation of the load table icons.

Titen HD® Design Information — Concrete

Load Adjustment Factors for Titen HD® Anchors in Normal-Weight Concrete: Edge Distance, Tension and Shear Loads

How to use these charts:

1. The following tables are for reduced edge distance.
2. Locate the anchor size to be used for either a tension and/or a shear load application.
3. Locate the anchor embedment (E) used for either a tension and/or a shear load application.
4. Locate the edge distance (s_{act}) at which the anchor is to be installed.
5. The load adjustment factor (f_s) is the intersection of the row and column.
6. Multiply the allowable load by the applicable load adjustment factor(s).
7. Reduction factors for multiple edges are multiplied together.

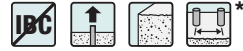

Spacing Tension (f_s)

s_{act} (in)	Dia.	$\frac{3}{8}$			$\frac{1}{2}$			$\frac{5}{8}$			$\frac{3}{4}$		
	E	1½	2¼	3¾	2¼	3½	5¼	2¼	4⅛	5¾	2¼	4⅝	5¾
	s_{cr}	4	6	6	8	8	8	10	10	10	12	12	12
	s_{min}	4	1½	1½	2	2	2	2½	2½	2½	3	3	3
	f_{smin}	1.00	0.66	0.56	0.72	0.63	0.76	0.79	0.69	0.73	0.80	0.70	0.72
1													
1½			0.66	0.56									
2			0.70	0.61	0.72	0.63	0.76						
2½			0.74	0.66	0.74	0.66	0.78	0.79	0.69	0.73			
3			0.77	0.71	0.77	0.69	0.80	0.80	0.71	0.75	0.80	0.70	0.72
4		1.00	0.85	0.80	0.81	0.75	0.84	0.83	0.75	0.78	0.82	0.73	0.75
5			0.92	0.90	0.86	0.82	0.88	0.86	0.79	0.82	0.84	0.77	0.78
6			1.00	1.00	0.91	0.88	0.92	0.89	0.83	0.86	0.87	0.80	0.81
7					0.95	0.94	0.96	0.92	0.88	0.89	0.89	0.83	0.84
8					1.00	1.00	1.00	0.94	0.92	0.93	0.91	0.87	0.88
9								0.97	0.96	0.96	0.93	0.90	0.91
10								1.00	1.00	1.00	0.96	0.93	0.94
11											0.98	0.97	0.97
12											1.00	1.00	1.00

See notes below



Spacing Shear (f_s)

s_{act} (in)	Dia.	$\frac{3}{8}$			$\frac{1}{2}$			$\frac{5}{8}$			$\frac{3}{4}$		
	E	1½	2¼	3¾	2¼	3½	5¼	2¼	4⅛	5¾	2¼	4⅝	5¾
	s_{cr}	4	0	0	0	0	0	0	0	0	0	0	0
	s_{min}	4	0	0	0	0	0	0	0	0	0	0	0
	f_{smin}	1.00	0.77	0.77	0.77	0.77	0.77	0.77	0.77	0.77	0.77	0.77	0.77
1													
1½			0.77	0.77	0.88								
2			0.80	0.80	0.77	0.77	0.77						
2½			0.82	0.82	0.79	0.79	0.79	0.77	0.77	0.77			
3			0.85	0.85	0.81	0.81	0.81	0.79	0.79	0.79	0.77	0.77	0.77
4		1.00	0.90	0.90	0.85	0.85	0.85	0.82	0.82	0.82	0.80	0.80	0.80
5			0.95	0.95	0.89	0.89	0.89	0.85	0.85	0.85	0.82	0.82	0.82
6			1.00	1.00	0.92	0.92	0.92	0.88	0.88	0.88	0.85	0.85	0.85
7					0.96	0.96	0.96	0.91	0.91	0.91	0.87	0.87	0.87
8					1.00	1.00	1.00	0.94	0.94	0.94	0.90	0.90	0.90
9								0.97	0.97	0.97	0.92	0.92	0.92
10								1.00	1.00	1.00	0.95	0.95	0.95
11											0.97	0.97	0.97
12											1.00	1.00	1.00

The tabled adjustment values (f_s) have been calculated using the following information:

1. E = Embedment depth (inches).
2. s_{act} = actual spacing distance at which anchors are installed (inches).
3. s_{cr} = critical spacing distance for 100% load (inches).
4. s_{min} = minimum spacing distance for reduced load (inches).
5. f_s = adjustment factor for allowable load at actual spacing distance.
6. $f_{s_{cr}}$ = adjustment factor for allowable load at critical spacing distance. $f_{s_{cr}}$ is always = 1.00.
7. $f_{s_{min}}$ = adjustment factor for allowable load at minimum spacing distance.
8. $f_s = f_{s_{min}} + [(1 - f_{s_{min}}) (s_{act} - s_{min}) / (s_{cr} - s_{min})]$.

* See page 12 for an explanation of the load table icons.

Titen HD® Design Information — Masonry

Load-Adjustment Factors for Titen HD® Anchors in Face-of-Wall Installation in 8" Grout-Filled CMU: Edge Distance and Spacing, Tension and Shear Loads

How to use these charts:

- The following tables are for reduced edge distance and spacing.
- Locate the anchor size to be used for either a tension and/or shear load application.
- Locate the embedment (E) at which the anchor is to be installed.
- Locate the edge distance (C_{act}) or spacing (S_{act}) at which the anchor is to be installed.
- The load adjustment factor (f_c or f_s) is the intersection of the row and column.
- Multiply the allowable load by the applicable load adjustment factor.
- Reduction factors for multiple edges or spacings are multiplied together.

Edge or End Distance Tension (f_c)

C_{act} (in.)	Dia.	3F8	½	5F8	3F4
	E	4½	3½	4½	4½
	C_{cr}	12	12	12	12
	C_{min}	4	4	4	4
	f_{cmin}	1.00	1.00	0.83	0.66
4		1.00	1.00	0.83	0.66
6		1.00	1.00	0.87	0.75
8		1.00	1.00	0.92	0.83
10		1.00	1.00	0.96	0.92
12		1.00	1.00	1.00	1.00

See notes below

Edge or End Distance Shear (f_c) Shear Load Perpendicular to Edge or End (Directed Towards Edge or End)

C_{act} (in.)	Dia.	¾	½	5/8	¾
	E	2¾	3½	4½	5½
	C_{cr}	12	12	12	12
	C_{min}	4	4	4	4
	f_{cmin}	0.58	0.38	0.30	0.21
4		0.58	0.38	0.30	0.21
6		0.69	0.54	0.48	0.41
8		0.79	0.69	0.65	0.61
10		0.90	0.85	0.83	0.80
12		1.00	1.00	1.00	1.00

- E = Embedment depth (inches).
- C_{act} = actual end or edge distance at which anchor is installed (inches).
- C_{cr} = critical end or edge distance for 100% load (inches).
- C_{min} = minimum end or edge distance for reduced load (inches).
- f_c = adjustment factor for allowable load at actual end or edge distance.
- f_{ccr} = adjustment factor for allowable load at critical end or edge distance.
 f_{ccr} is always = 1.00.
- f_{cmin} = adjustment factor for allowable load at minimum end or edge distance.
- $f_c = f_{cmin} + [(1 - f_{cmin})(C_{act} - C_{min}) / (C_{cr} - C_{min})]$.

Spacing Tension (f_s)

S_{act} (in.)	Dia.	¾	½	5/8	¾
	E	2¾	3½	4½	5½
	S_{cr}	6	8	10	12
	S_{min}	3	4	5	6
	f_{smin}	0.87	0.69	0.59	0.50
3		0.87			
4		0.91	0.69		
5		0.96	0.77	0.59	
6		1.00	0.85	0.67	0.50
8			1.00	0.84	0.67
10				1.00	0.83
12					1.00

- E = Embedment depth (inches).
- S_{act} = actual spacing distance at which anchors are installed (inches).
- S_{cr} = critical spacing distance for 100% load (inches).
- S_{min} = minimum spacing distance for reduced load (inches).
- f_s = adjustment factor for allowable load at actual spacing distance.
- f_{scr} = adjustment factor for allowable load at critical spacing distance. f_{scr} is always = 1.00.
- f_{smin} = adjustment factor for allowable load at minimum spacing distance.
- $f_s = f_{smin} + [(1 - f_{smin})(S_{act} - S_{min}) / (S_{cr} - S_{min})]$.

* See page 12 for an explanation of the load table icons.

Edge and End Distance Shear (f_c) Shear Load Parallel to Edge or End

C_{act} (in.)	Dia.	¾	½	5/8	¾
	E	2¾	3½	4½	4½
	C_{cr}	12	12	12	12
	C_{min}	4	4	4	4
	f_{cmin}	0.77	0.48	0.46	0.44
4		0.77	0.48	0.46	0.44
6		0.83	0.61	0.60	0.58
8		0.89	0.74	0.73	0.72
10		0.94	0.87	0.87	0.86
12		1.00	1.00	1.00	1.00

See notes below

Edge or End Distance Shear (f_c) Shear Load Perpendicular to Edge or End (Directed Away From Edge or End)

C_{act} (in.)	Dia.	¾	½	5/8	¾
	E	2¾	3½	4½	5½
	C_{cr}	12	12	12	12
	C_{min}	4	4	4	4
	f_{cmin}	0.89	0.79	0.58	0.38
4		0.89	0.79	0.58	0.38
6		0.92	0.84	0.69	0.54
8		0.95	0.90	0.79	0.69
10		0.97	0.95	0.90	0.85
12		1.00	1.00	1.00	1.00

Spacing Shear (f_s)

S_{act} (in.)	Dia.	¾	½	5/8	¾
	E	2¾	3½	4½	5½
	S_{cr}	6	8	10	12
	S_{min}	3	4	5	6
	f_{smin}	0.62	0.62	0.62	0.62
3		0.62			
4		0.75	0.62		
5		0.87	0.72	0.62	
6		1.00	0.81	0.70	0.62
8			1.00	0.85	0.75
10				1.00	0.87
12					1.00