

HR-251 IMPACT CURTAIN WALL 2-1/2" X 7 1/2"  
FINISH CLEAR  
DOOR NUMBER(S): 1 A\*4

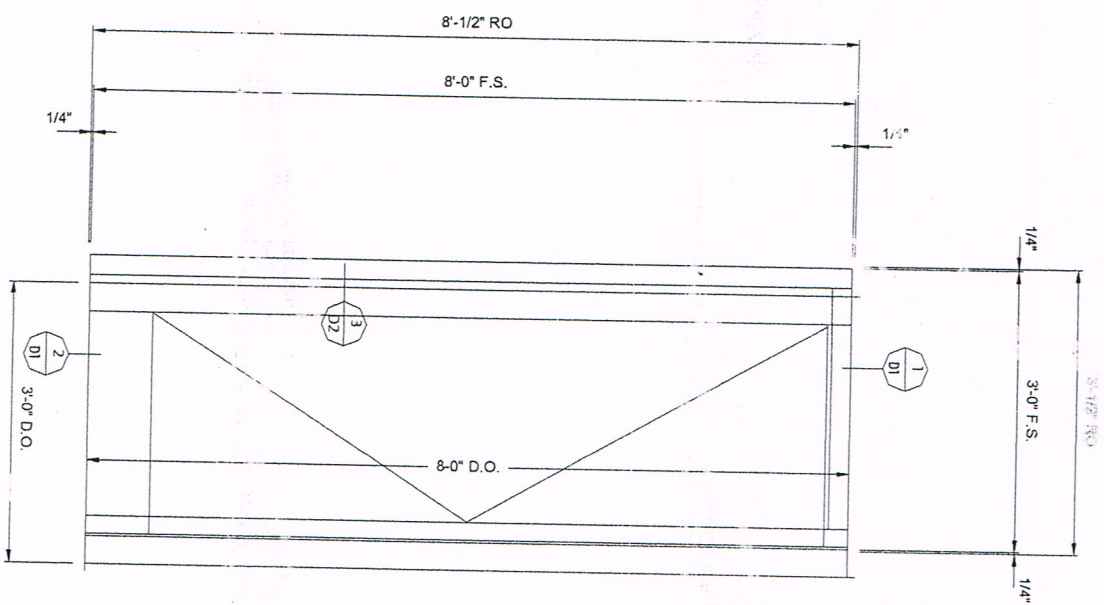

HR-251 IMPACT CURTAIN WALL 2-1/2" X 7 1/2"  
FINISH CLEAR  
DOOR NUMBER(S): 2

PROJECT Woodmere Community Center	CUSTOMER J.A. Jack Julius	ARCHITECT Meyer Engineers, Ltd.	Slidell Glass, Inc.		MANUAL COMP	REV	BY	DATE	DESCRIPTION
			Slidell LA						
PROJECT NO.	DATE 12/06/13	SCALE 1" = 1'-0"							
DRAWING NO. E1.mdf	SHEET E1								



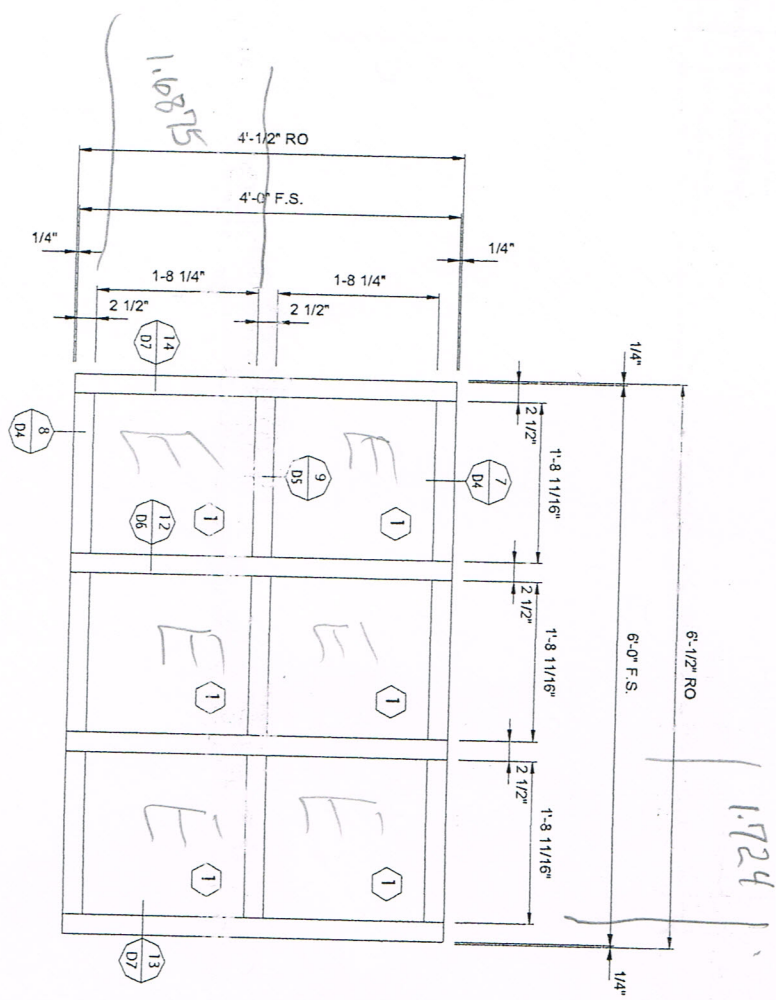

HR-251 IMPACT CURTAINWALL 2-1/2" X 7 1/2"  
 3 THUS REQ'D  
 FINISH: CLEAR

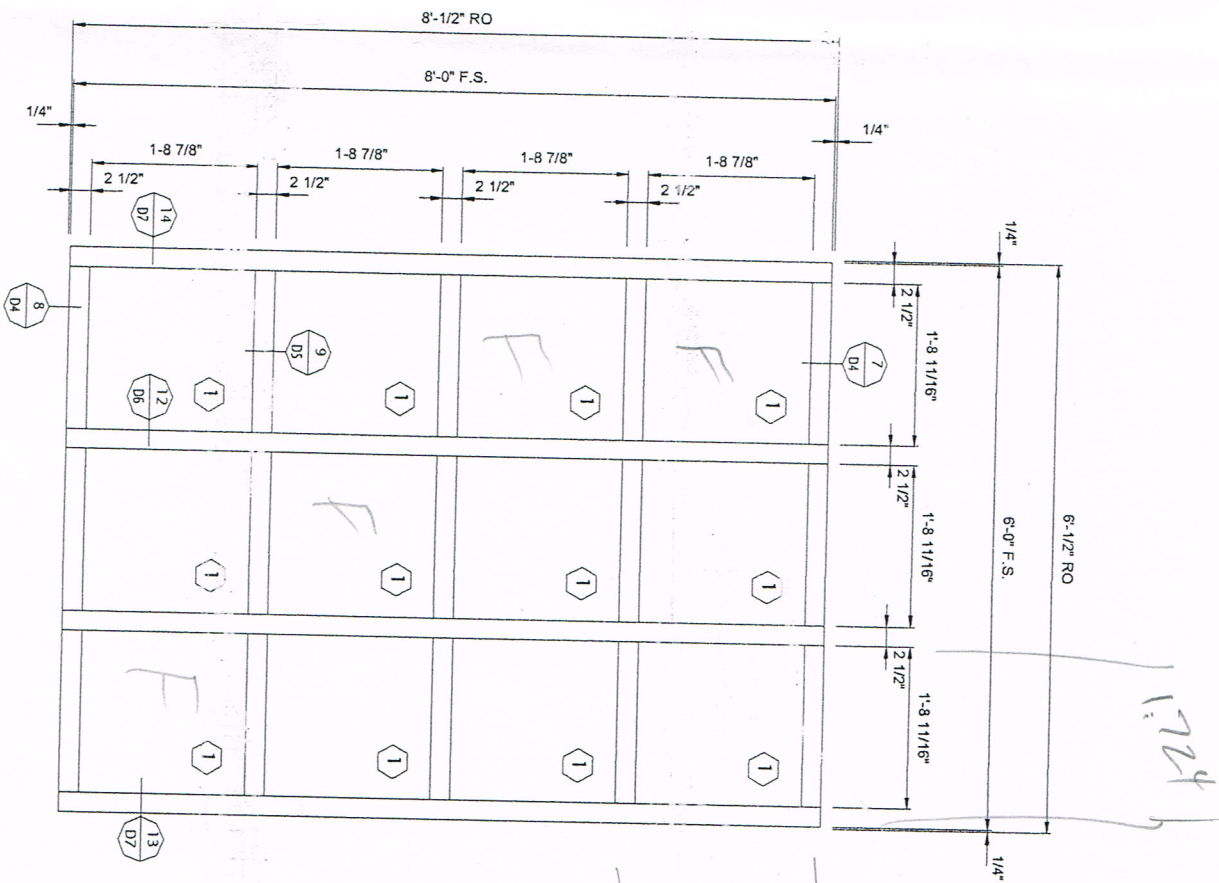

HR-251 IMPACT CURTAINWALL 2-1/2" X 7 1/2"  
 2 THUS REQ'D  
 FINISH: CLEAR

REV	BY	DATE	DESCRIPTION

Slidell Glass, Inc.  
 Slidell LA

PROJECT  
**Woodmere Community Center**  
 CUSTOMER  
**J.A. Jack Julius**  
 ARCHITECT  
**Meyer Engineers, Ltd.**

DRAWN  
 DATE 12/06/13  
 SCALE 1" = 1'-0"  
 DRAWING NO. E3.vdf  
 SHEET E3

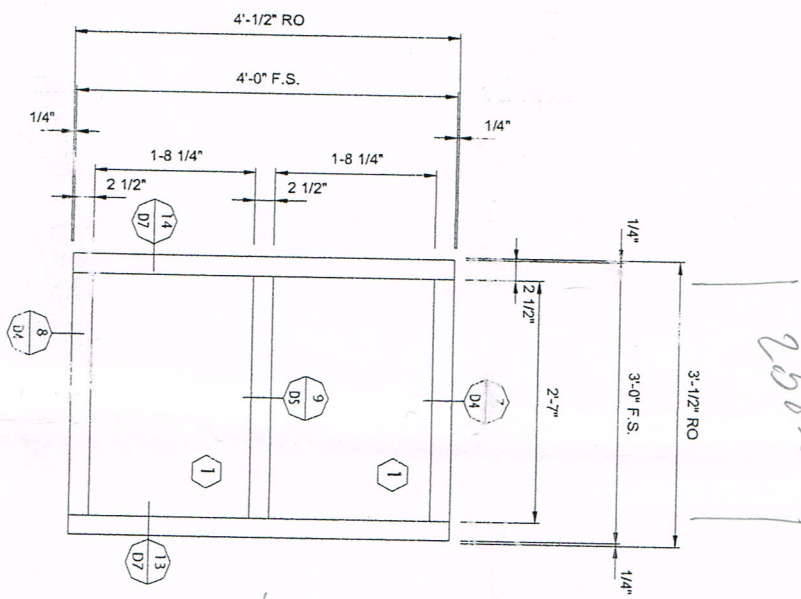

HR-251 IMPACT CURTAINWALL 2'-1/2" X 7'-1/2"  
 1 THUS REQ'D  
 FINISH: CLEAR

25833

1.6875

REV	R.	DATE	DESCRIPTION

Slidell Glass, Inc.  
 Slidell LA

PROJECT  
 Woodmere Community Center  
 CUSTOMER  
 J.A. Jack Julius  
 ARCHITECT  
 Meyer Engineers, Ltd.

PROJECT NO.  
 DRAWING NO.  
 E4.vdf  
 SHEET  
 E4

SCALE  
 1" = 1'-0"

DATE  
 12/06/13



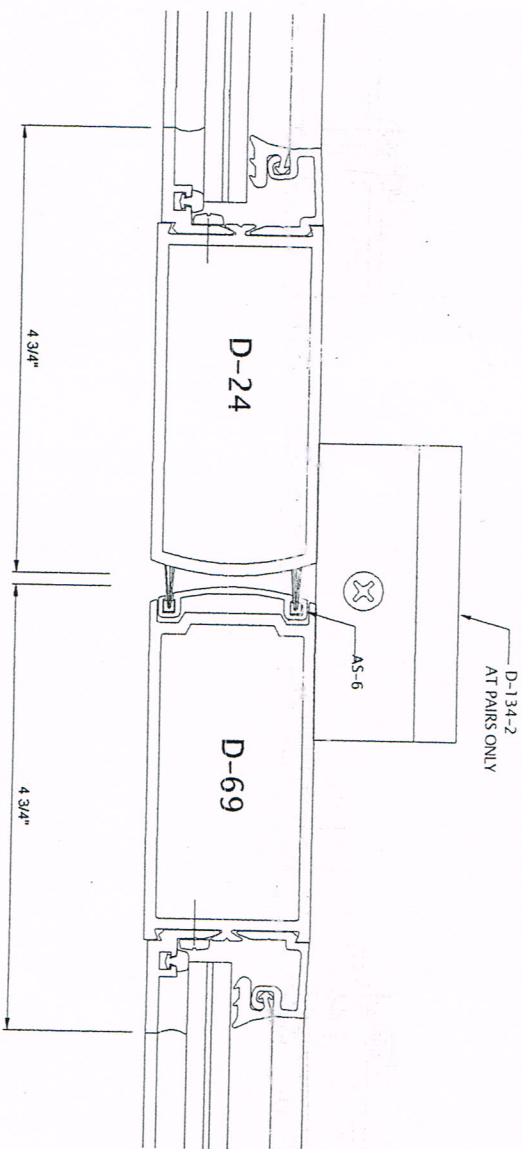
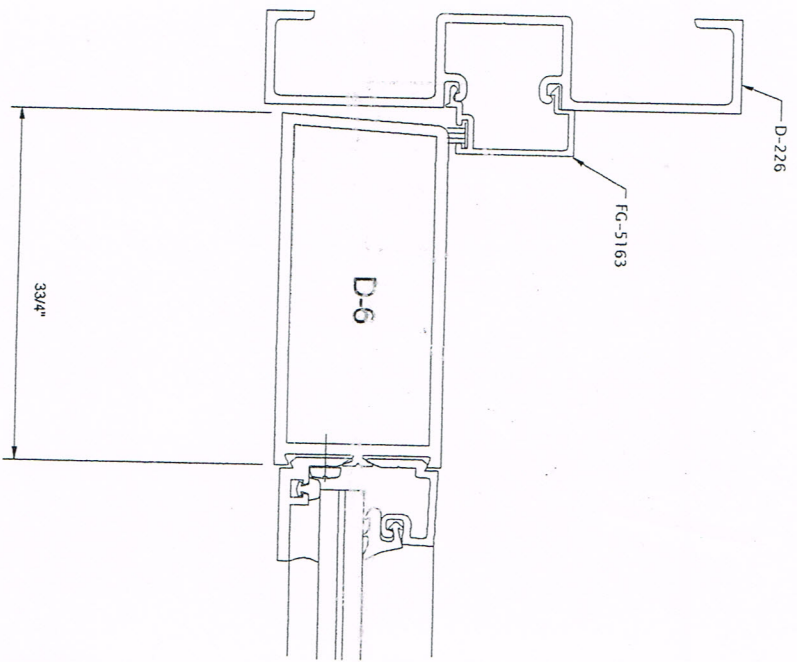

3

4

REV	BY	DATE	DESCRIPTION

Slidell Glass, Inc.  
Slidell LA

PROJECT  
Woodmere Community Center

CUSTOMER  
J.A. Jack Julius

ARCHITECT  
Meyer Engineers, Ltd.

PROJECT NO.

DRAWN

DATE  
12/06/13

SCALE  
24

DRAWING NO.  
D2.vdf

SHEET  
D2

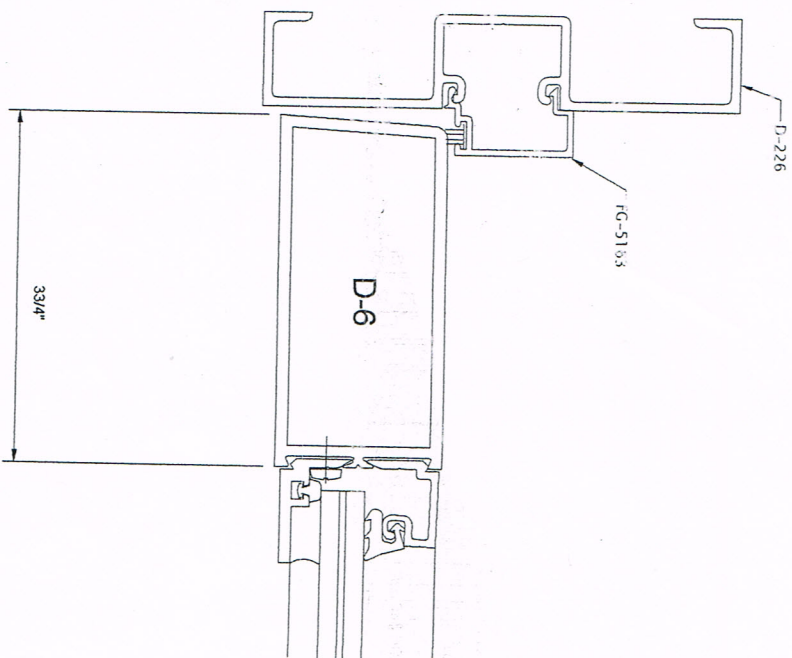
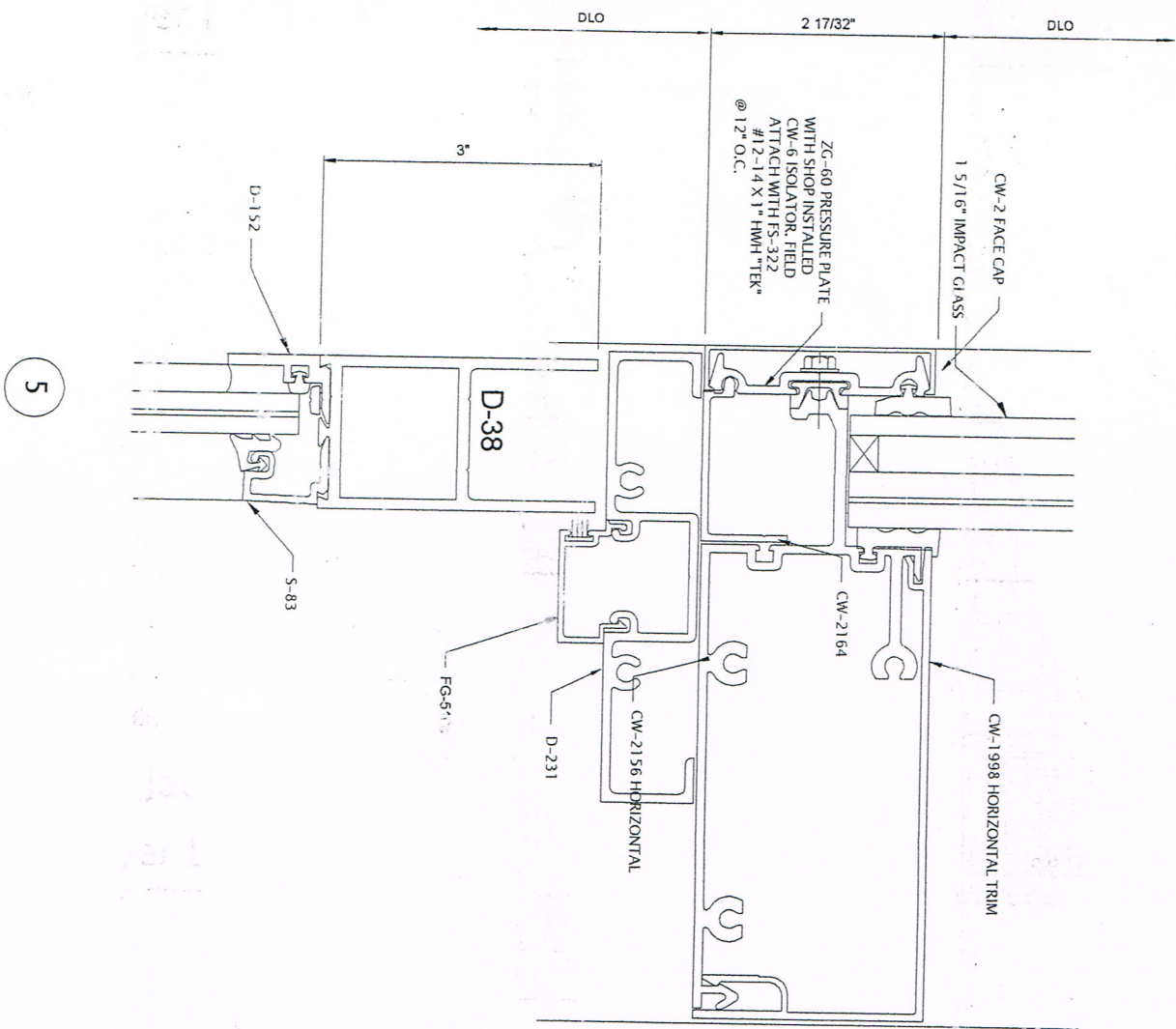

PROJECT  
Woodmere Community Center  
CUSTOMER  
J.A. Jack Julius  
ARCHITECT  
Meyer Engineers, Ltd.

Slidell Glass, Inc.  
Slidell LA

REV	BY	DATE	DESCRIPTION

PROJECT NO.  
DRAWN  
DATE  
12/06/13  
SCALE  
24  
DRAWING NO.  
D3.vdf  
SHEET  
D3

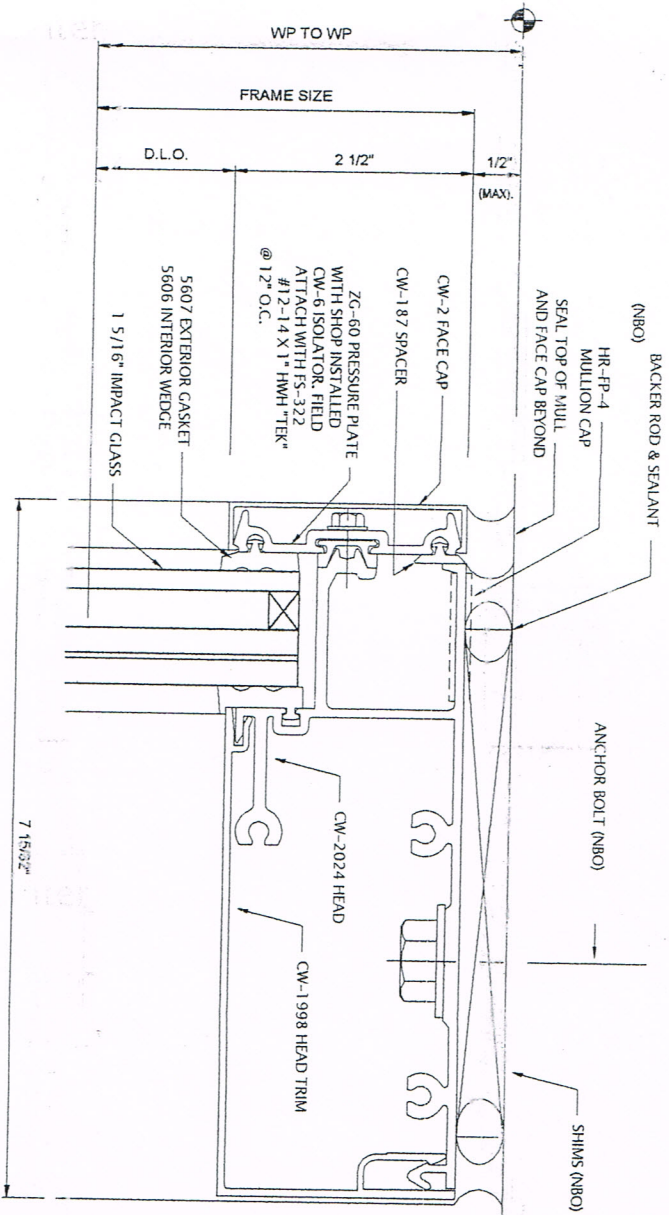

7

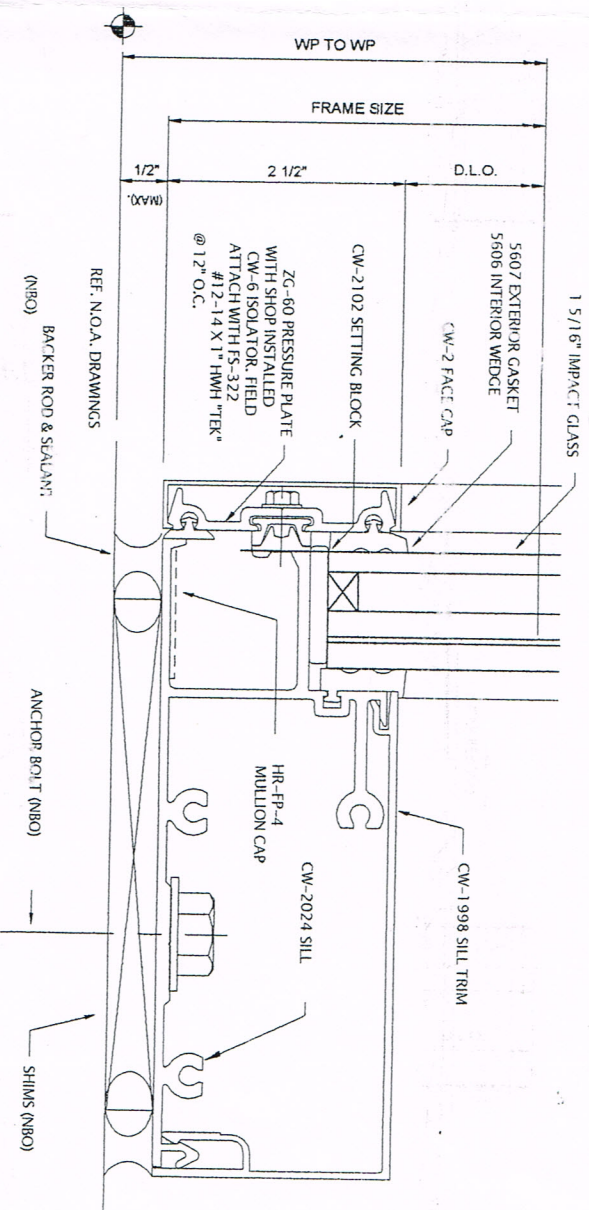

8

PROJECT  
Woodmere Community Center  
CUSTOMER  
J.A. Jack Julius  
ARCHITECT  
Meyer Engineers, Ltd.

Slidell Glass, Inc.  
Slidell LA

REV	BY	DATE	DESCRIPTION

DRAWING NO.  
D4.vdf  
SHEET  
D4  
SCALE  
24  
DATE  
12/06/13

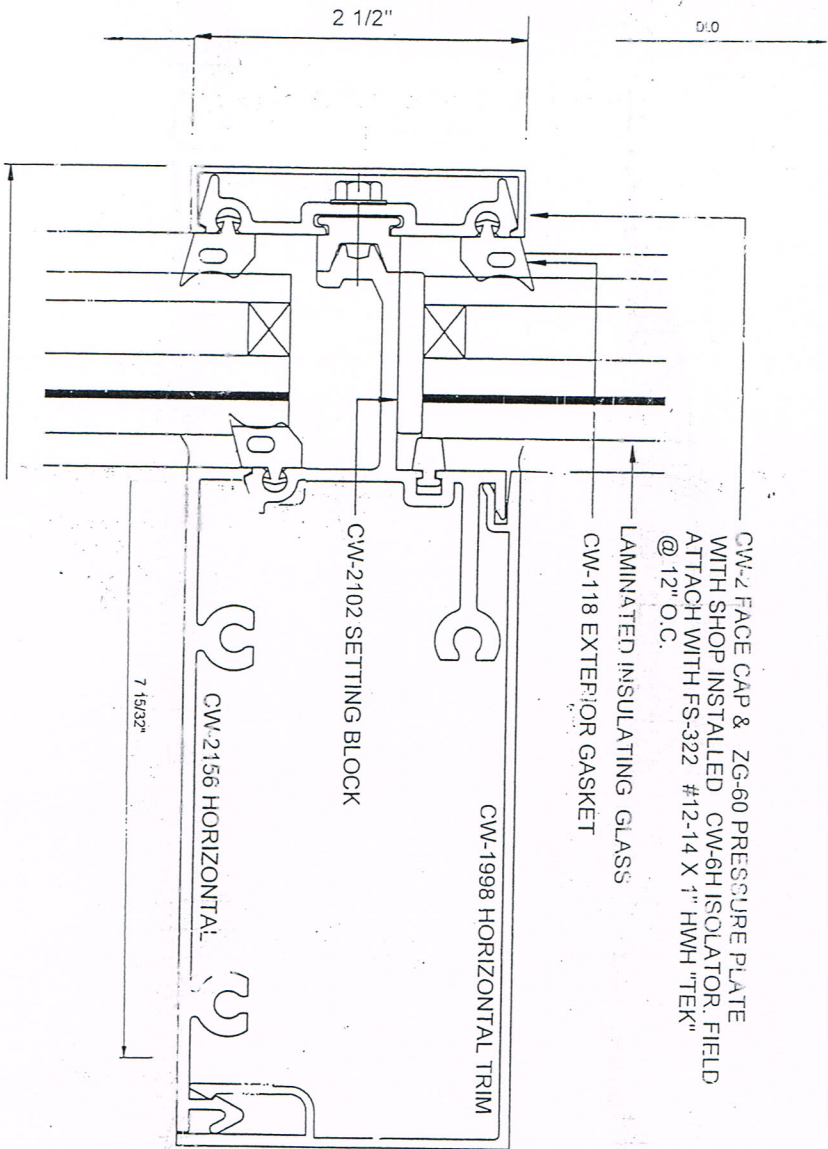

9

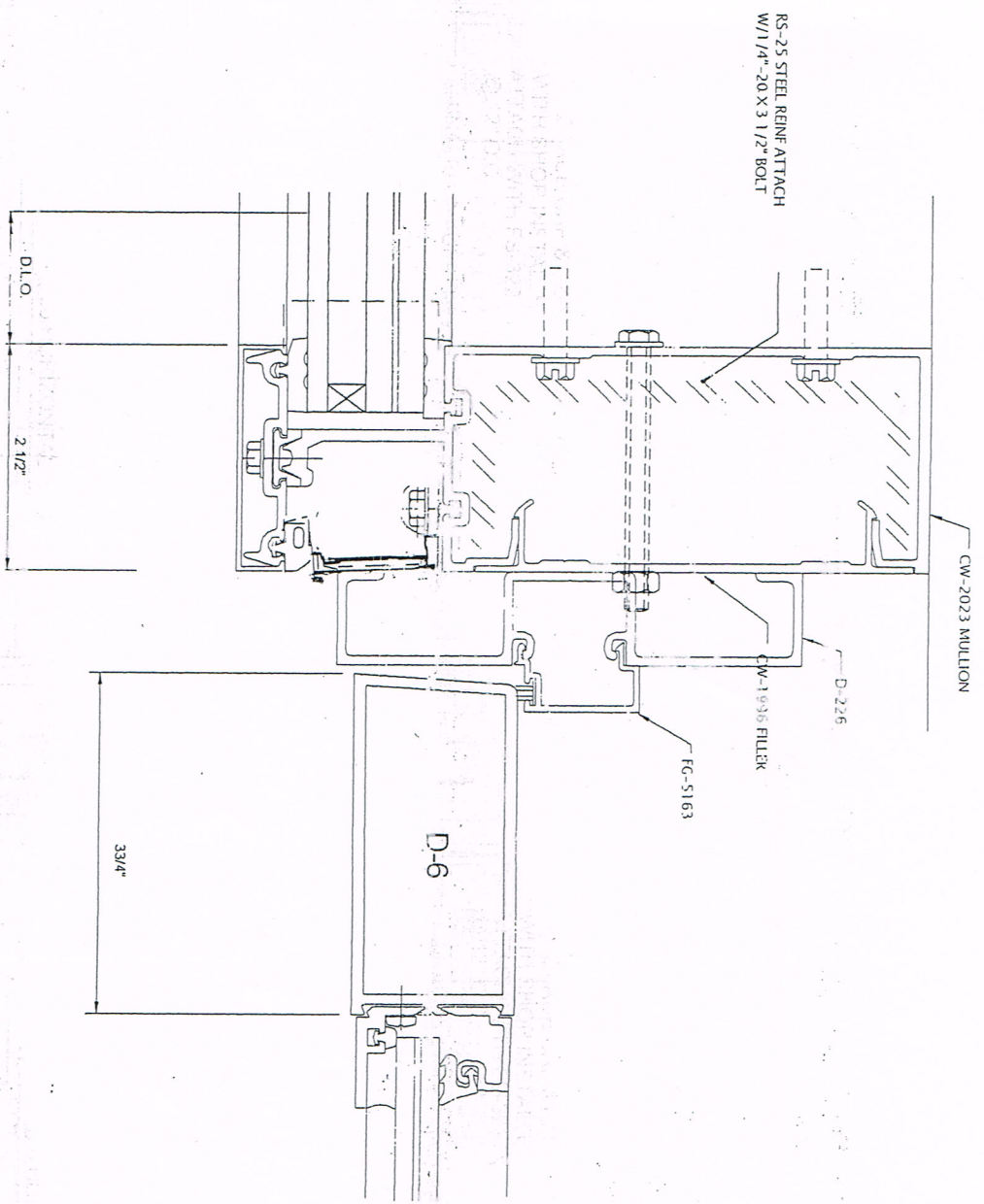

10

PROJECT  
**Woodmere Community Center**  
 CUSTOMER  
**J.A. Jack Julius**  
 ARCHITECT  
**Meyer Engineers, Ltd.**

**Slidell Glass, Inc.**  
 Slidell LA

REV	BY	DATE	DESCRIPTION

DRAWING NO. **D5.vdf**  
 SCALE **24**  
 DATE **12/06/13**  
 SHEET **D5**

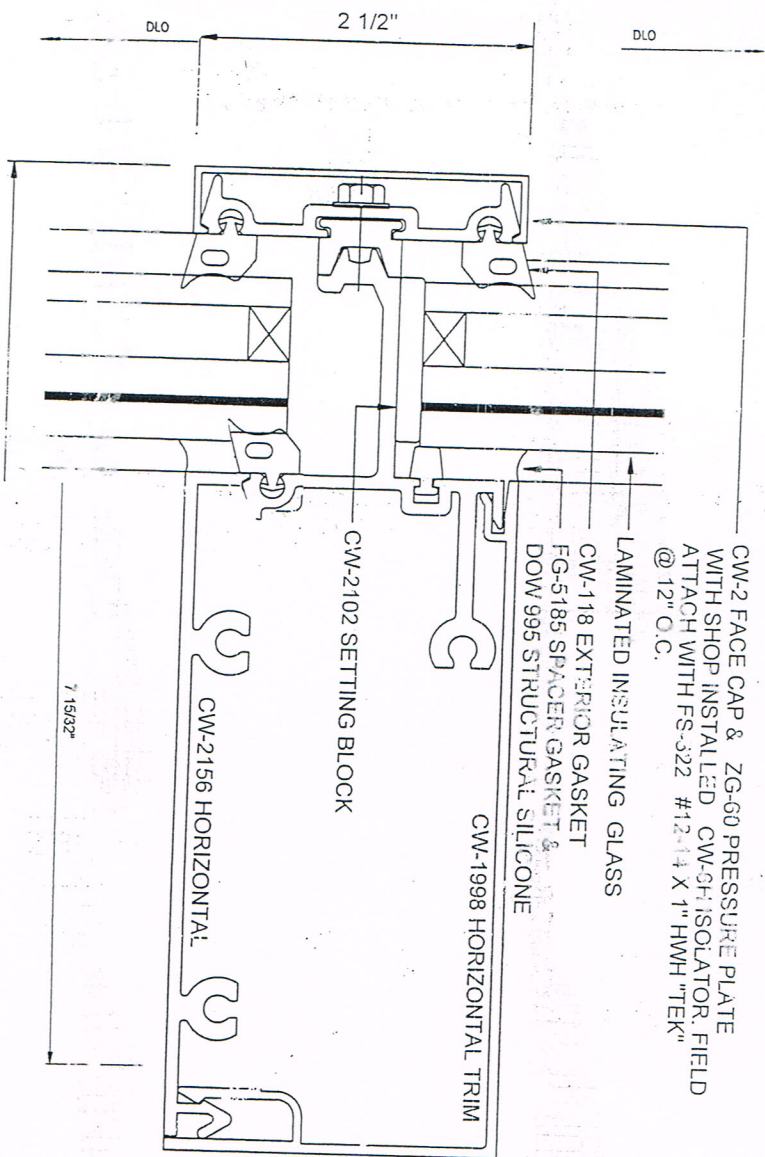

11

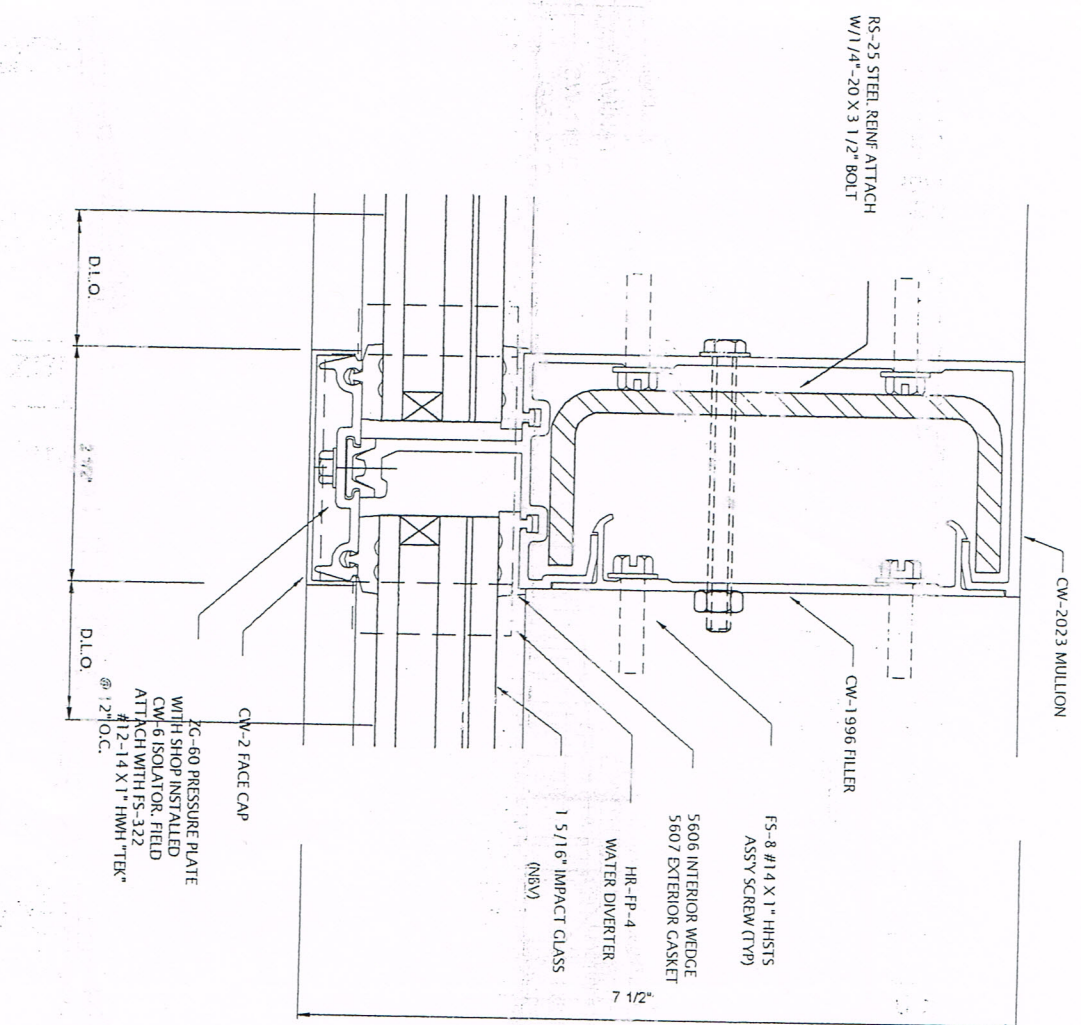

12

PROJECT  
**Woodmere Community Center**  
 CUSTOMER  
**J.A. Jack Julius**  
 ARCHITECT  
**Meyer Engineers, Ltd.**

Slidell Glass, Inc.  
 Slidell LA

REV	BY	DATE	DESCRIPTION

DRAWN  
 DATE  
 12/06/13  
 SCALE  
 24  
 DRAWING NO.  
 D6.vdf  
 SHEET  
 D6

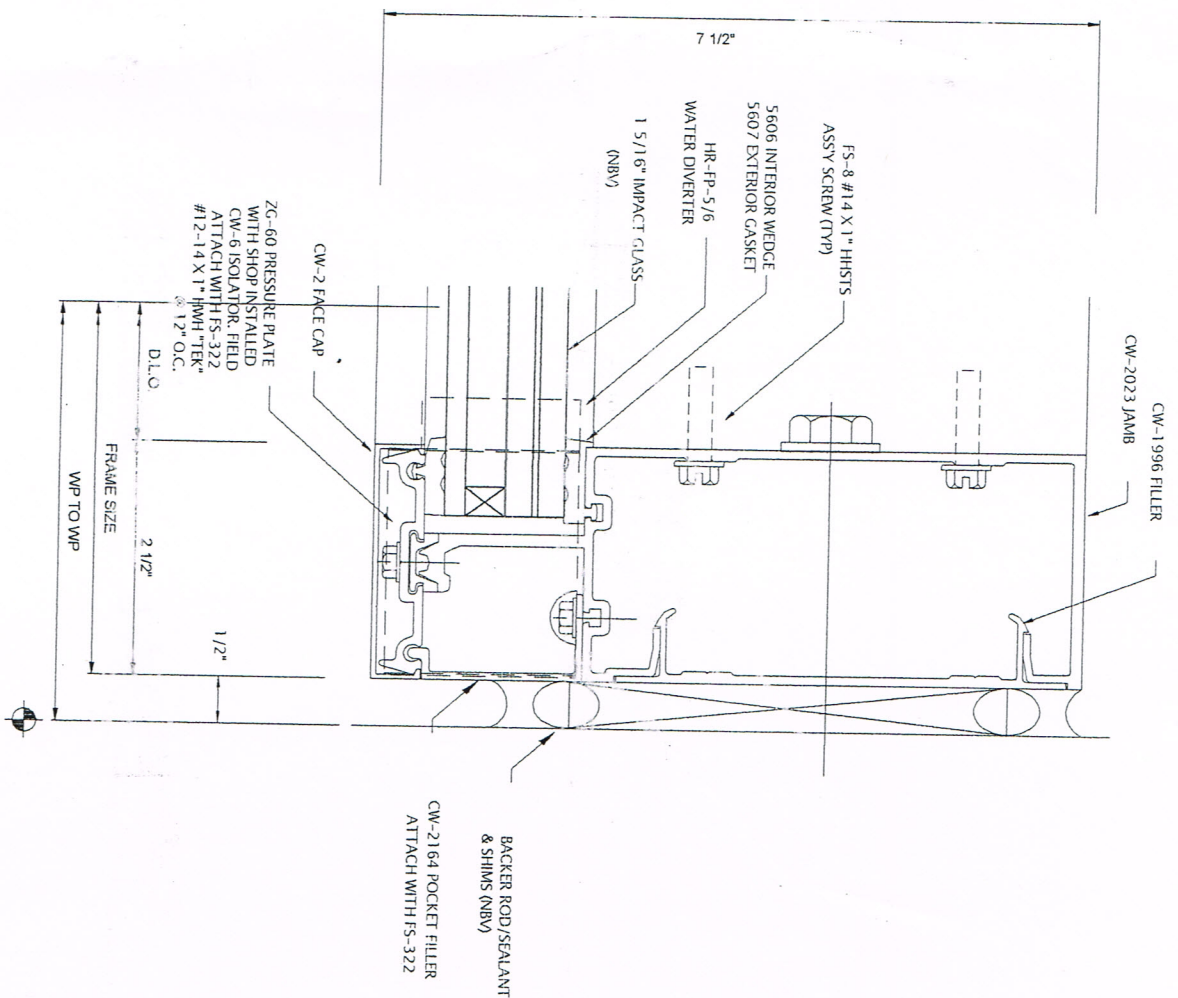

13

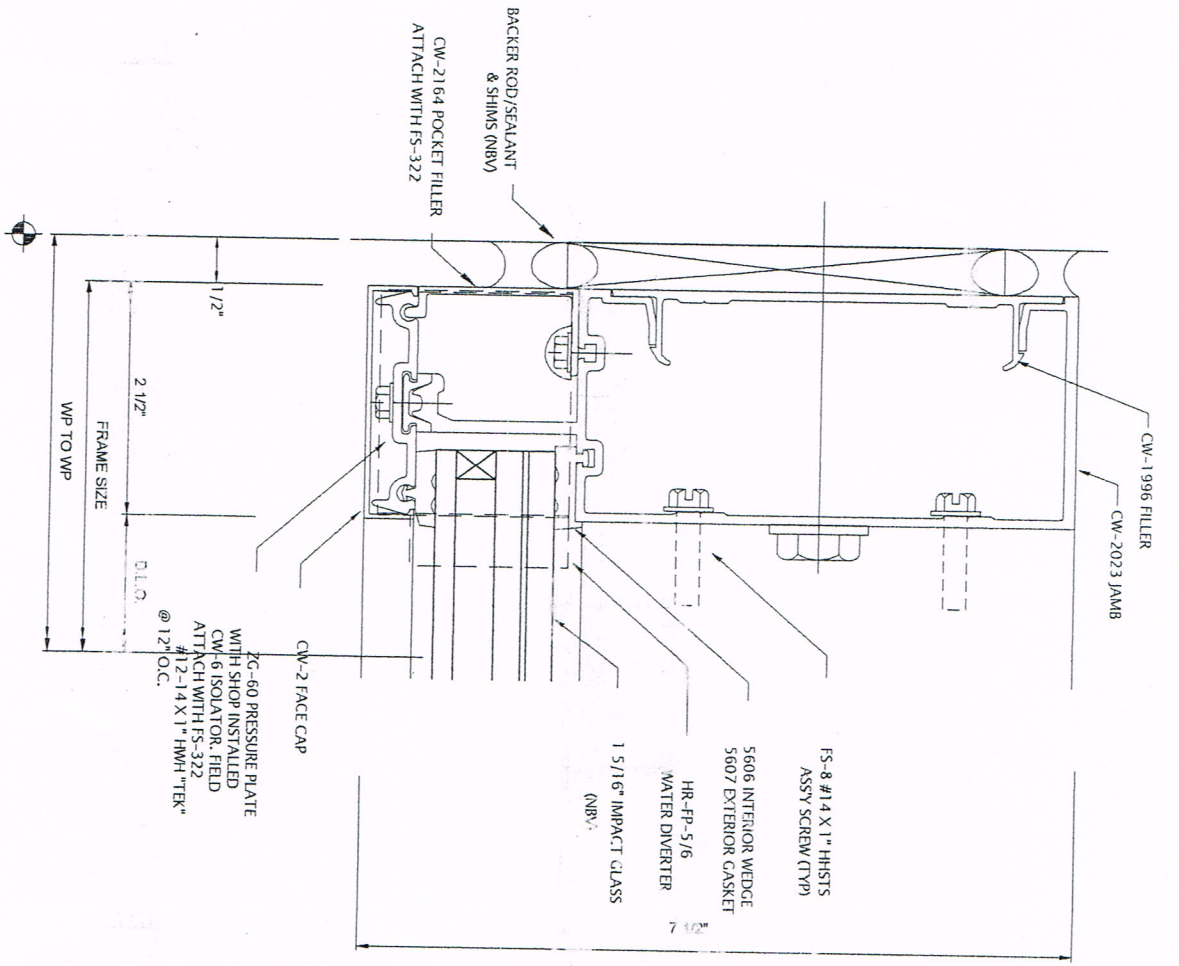

14

PROJECT <b>Woodmere Community Center</b>	CUSTOMER <b>J.A. Jack Julius</b>	ARCHITECT <b>Meyer Engineers, Ltd.</b>	Slidell Glass, Inc.		MANUAL COMP	
			Slidell LA			
DRAWN	DATE	SCALE	REV	BY	DATE	DESCRIPTION
	12/06/13	24				
DRAWING NO. <b>D7.vdf</b>	SHEET <b>D7</b>					