

1-INNER & OUTER SKID  
DETAIL @ EVERY JOIST

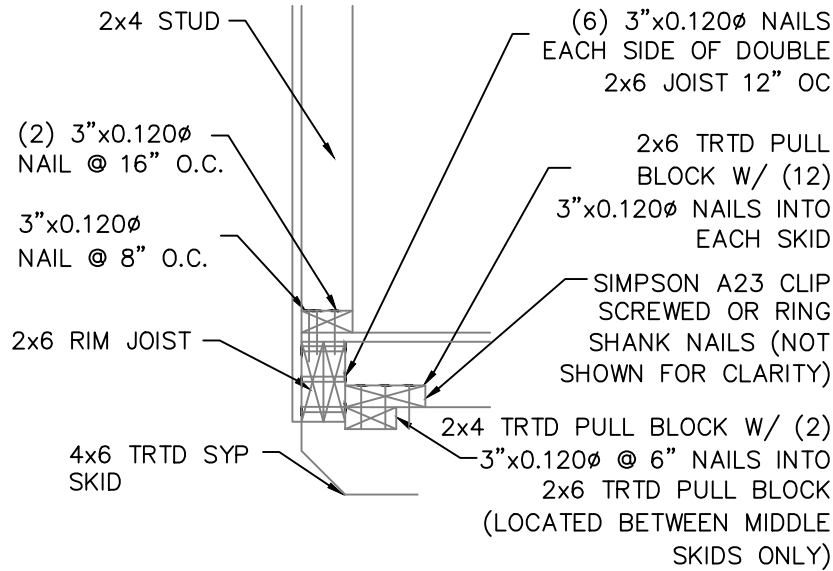

2-ENTRY DOOR ENDWALL JOIST DETAIL

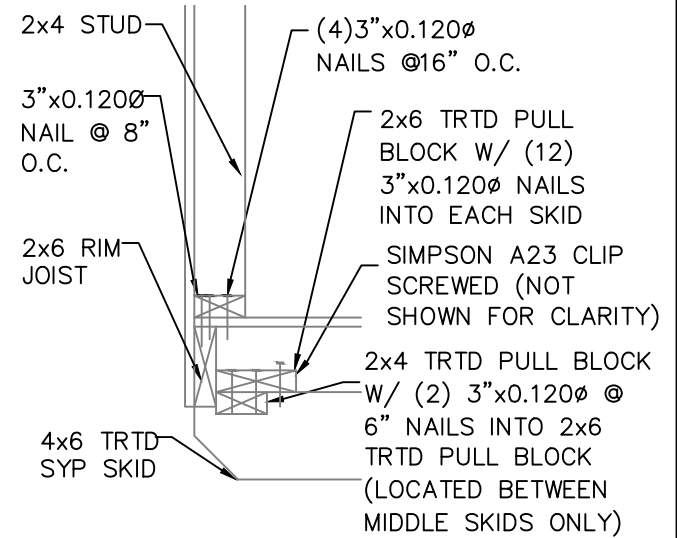

3-REAR ENDWALL JOIST DETAIL

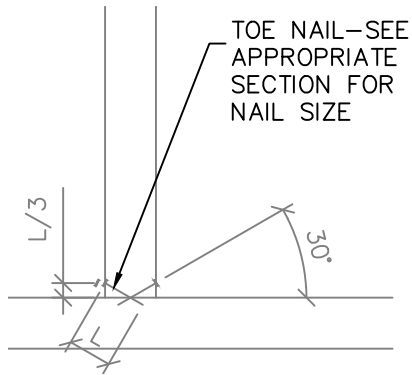

4-TOE-NAIL DETAIL

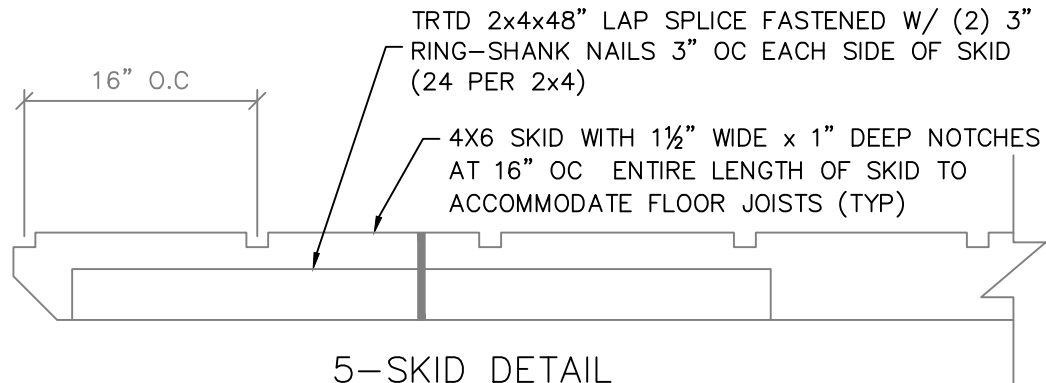

5-SKID DETAIL



**APEX BUILDERS AND ASSOCIATES**

504-858-6544

DRAWN BY: TNT

SCALE: NTS

DATE: 03-07-2022

SHEET TITLE: BUILD DETAILS 2

DRAWING NUMBER:

**S-110**



**DAMMON ENGINEERING, INC.**

554 Old Spanish Trail Slidell, LA 70458 (985) 649-5832

Chief Engineer: Brian Mistich, PE  
554 Old Spanish Trail  
Slidell, LA 70458

www.dammonengineering.com  
info@dammonengineering.com  
PHONE: 985-649-5832