

Ordering Information

Applicable product:		
Three-hole bar sink	K-6540-3	shown
Two-hole bar sink	K-6540-2	not shown
One-hole bar sink	K-6540-1	not shown
Accessories/hardware:		
Hardwood cutting board	K-6508	optional

Product Information

Fixture*:		basin area	water depth
Sink		12" x 13"	6-1/2"
Outlet	3-5/8" D.		
Faucet holes	1-3/8" D.		

* Approximate measurements for comparison only.

Installation Notes

Refer to installation instructions included with fixture before beginning installation.

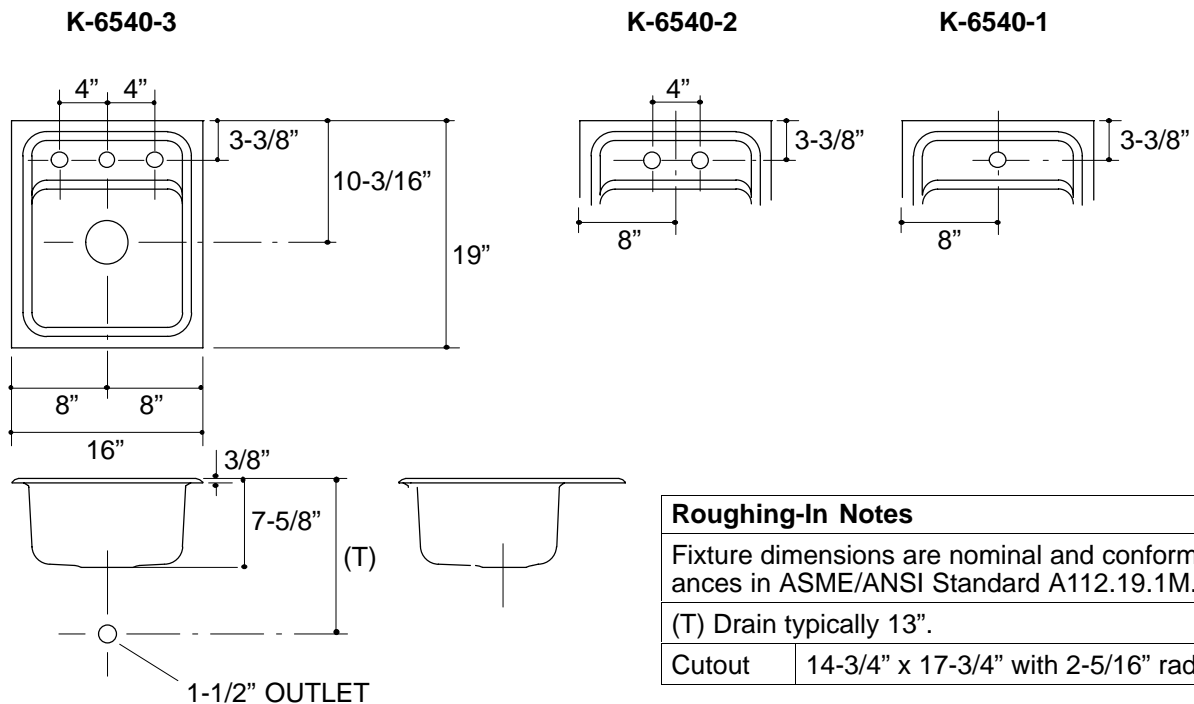

Roughing-In Notes	
Fixture dimensions are nominal and conform to tolerances in ASME/ANSI Standard A112.19.1M.	
(T) Drain typically 13".	
Cutout	14-3/4" x 17-3/4" with 2-5/16" radius corners.