

Ordering Information

Applicable product:		
Seat on left	K-12211	shown
Seat on right	K-12212	not shown
Accessories/hardware:		
Drain	K-9132	recommended
Mastershower™ Handshower	K-9500	recommended*
Revival™ valve trim	K-T16117-4A	recommended
Rite-Temp™ valve	K-304-K	recommended
Dome light	K-1570	optional
Helios™ shower door	K-704014	optional
* Dimensions illustrated		

Product Information

Fixture:	255 lbs.
Configuration	3-piece
Drain Outlet	3-3/8" D.

Installation Notes

Refer to installation instructions included with fixture before beginning installation.

For increased accessibility, utilize "pit" installation as detailed in instructions.

For optimum accessibility, specify faucets and fittings to install and operate within the control area shown.

Fixture not drilled for supply fittings.

Shimming may be required to level fixture.

Roughing-In Notes

Fixture conforms to ANSI Standard Z124.2. All dimensions are nominal.

*Recess opening must be 52-1/4" x 84-1/4".

No change in measurements if connected with drain illustrated.

Stud opening tolerance (+ 1/4" - 0"). When fire rated wall is specified, dimensions are to the inside of the wall board. Some shimming between stud frame and fixture may be required.

Provide clear floor space per ICC/ANSI A117.1, and as shown.

	Represents control area for faucets.
	Represents 24" wall mount slide bar.
	Represents clear floor space for 36" x 43" side entrance.
	Represents clear floor space for 48" x 43" front entrance.

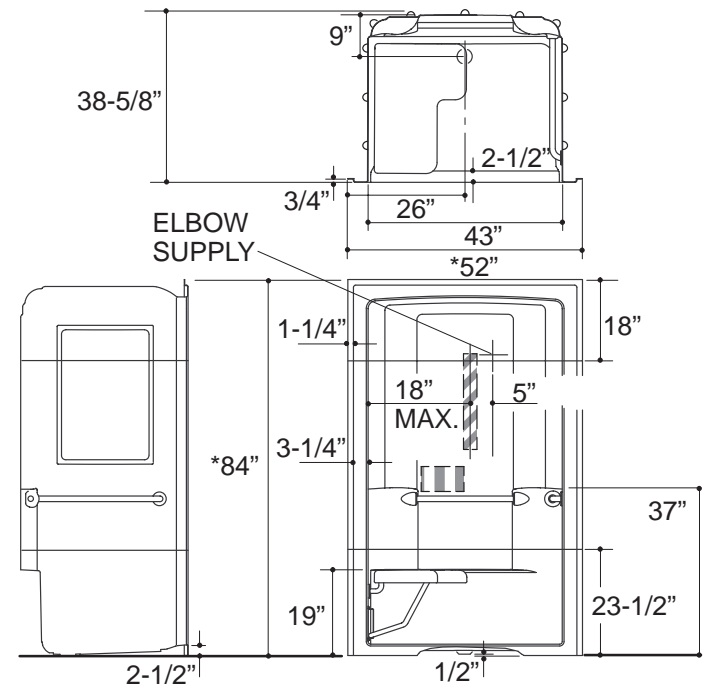

.75<132