

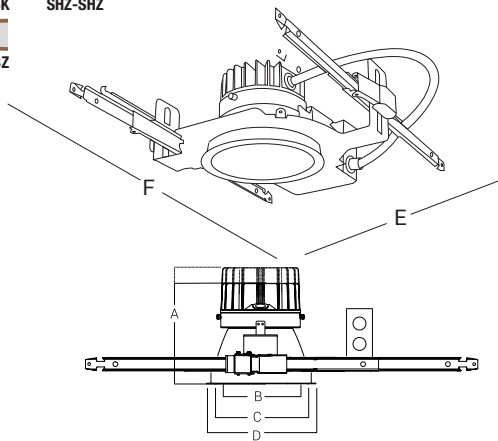

REFLECTOR/  
FLANGE COLORS

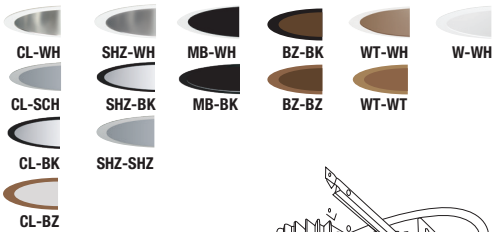

A 900L to 4000L: Height = 5-5/8"  
A 6000L to 8000L: Height = 9"  
B: Trim Aperture = 6-3/16"  
C: Cut-Out = 6-13/16"  
D: Trim Outside Dia = 7-3/8"  
E: Width = 16"  
F: Length = 20-33"

NOMINAL LUMENS	DELIVERED LUMENS	WATTAGE
6000	6696	61 W
4000	4575	38 W
3000	3374	32 W
2000	2252	20 W
1500	1785	15 W
1200	1422	11 W
900	1065	9 W
NOMINAL LUMENS (HP)	DELIVERED LUMENS (HP)	WATTAGE (HP)
1200	1398	12W
2000	2102	18W
3000	3259	28W

Based on 4000K, 90+CRI with semi-specular chrome reflector.

Actual wattage may vary +/-5%

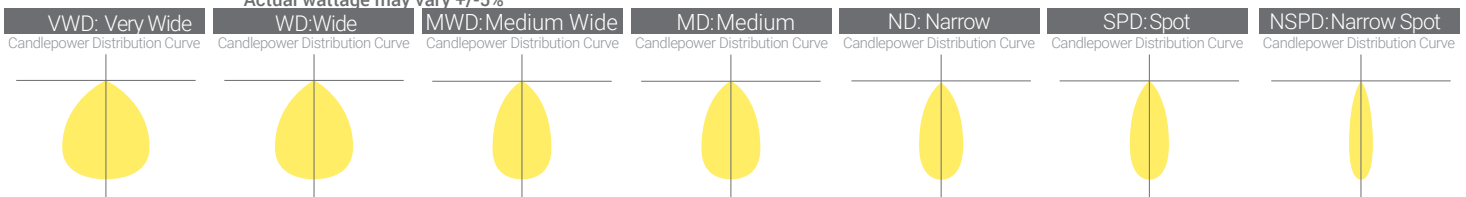

Reference IES files for additional distribution curve information.

**FEATURES**

A highly sustainable and ultra-efficient architectural LED downlight that provides even, glare-free illumination. Available in a range of finishes, distributions, and lumen packages, it is ideally suited for use in corporate office space, hospitality, healthcare, commercial, academic, churches and retail.

**OPTICS AND REFLECTOR**

The reflector has a 45° visual cutoff, and is shipped standard with a Solite lens in a smooth frosted finish. Spun from 0.05" thick aluminum, with a 1-step anodized finish, and available in different colors or custom RAL finishes. Reflector flange options include self-flanged and white painted flange. Various distribution options are available, and all optics are field changeable.

<b>LUMENS</b>	900, 1200, 1500, 2000, 3000, 4000, 6000 (Custom lumen packages available)
<b>CCT &amp; DYNAMIC PLATFORMS</b>	22K, 27K, 30K, 35K, 40K, 50K, Tunable White, Dims to Warm, RGB + White
<b>CRI</b>	90+ Standard, 98+ Optional
<b>COLOR QUALITY</b>	2 Step MacAdam Ellipse
<b>DISTRIBUTIONS</b>	VWD, WD, MWD, MD, ND, SPD, NSPD
<b>TRIM OPTIONS</b>	Downlight, Wall Wash, Double Wall Wash, Wet Location
<b>REFLECTOR COLORS</b>	CL (Semi-Specular Chrome), SHZ (Low Iridescent Satin Haze), WT (Wheat), W (White), MB (Black), BZ (Bronze)
<b>FLANGE COLORS</b>	Self-Flanged WH (White), SCH (Semi-Specular Chrome), SHZ (Low Iridescent Satin Haze), BK (Black), BZ (Bronze)
<b>DIMMING</b>	0-10V Flicker Free 1% Dimming Standard (DIM10), LUTH, LUTFB, LUT2W, ELDO10.1, ELDODMX.1, ELDODALI.1, DIMTR, BLE
<b>EMERGENCY</b>	10W - Up to 1000L Output 20W - Up to 2000L Output EMG-LED-G2-10W-SDT - Self Diagnostic (Consult Factory)
<b>LIFETIME</b>	L70 at 102,000 Hours
<b>PHOTOMETRIC TESTS</b>	In Accordance with IES LM79-08, LM80 and TM-30, TM-21





**THERMAL MANAGEMENT SYSTEM**

Passive cooling Diecast Aluminum Heat Sink, LED light engine and driver are replaceable, upgradeable, and can be accessed from below the ceiling. The consistency in the quality of light is delivered with precision performance by the use of a unique locking mechanism that aligns the reflector with the light engine.

**MOUNTING FRAME & BRACKETS**

The downlight mounting frame is a fabricated assembly constructed of 16-gauge steel, with C-channel mounting brackets, included. The versatility of the mounting brackets allow for an adjustability of up to 28" horizontally, and 2-3/4" vertically, locking into place. With the added die-formed construction of the mounting frame, it provides maximum heat dissipation and rust protection.

**DRIVER ELECTRICAL INFORMATION**

The LED driver is rated for 50 to 60Hz at 120V/277V, also available in 347V input, produces less than 20%THD, has a power factor between 90% and 100%, and is thermally protected for additional safety. Junction box and Driver can be accessed from below the ceiling and above the ceiling. Junction Box is Listed for through branch circuit wiring.

**DIMMING & DRIVER INFORMATION**

**DIM10** - 0-10V dimming on either MVOLT 120, 277 or 347V. Dimmable down to 1% of initial lumens, standard.

**DIMTR** - Triac & Electronic low voltage dimming. Available in 120V, and up to 4000 lumens only.

**LUT2W** - Lutron LTEA2W Hi-Lume 1%. 2-wire LED Driver 120V Forward Phase only.

**LUTH** - Lutron LDE1 Hi-Lume 1% Eco System LED driver with Soft-on, Fade to Black dimming technology.

**LUTFB** - Lutron PEQ0E Hi-Lume Premier 1% Eco System LED Driver with Soft-on, Fade to Black dimming technology. Available on all luminaires up to 1500 lumens.

**ELDO10.1** - EldoLED SoloDrive 0-10V. Dimming down to 0.1%.

**DALI** - DALI DT6, DT8 dimming down to 1%.

**ELDODMX** - EldoLED PowerDrive dimming down to 0.1%.

Please see EldoLED website for wiring diagrams and a list of compatible DMX and DALI control systems.

**BLE** - Luminaires may be controlled, grouped, scheduled or placed in scenes and or zones Via Cassambi Bluetooth 4.0 App.

**LED DYNAMIC PLATFORM OPTIONS**

Tunable White with Smart White Technology utilizing the Lumenetix Platform allows you to color tune the luminaire via various controls. Create the perfect environment for the desired use of the space, while maintaining a CRI of 90+ across the tunable range of 8000 to 1650K. (Click here for more details)

Dims to Warm with Smart Dimming Technology. At 100% full brightness the luminaire is at 3000K. When dimmed to 1%, the light transitions to 1800K, creating a warm ambiance within the space. (Click here for more details)

RGB+White with Smart Hue Technology provides full color mixing of RGB and white colors. Utilizing the Lumenetix Platform allows you to choose from unlimited RGB color options, via various controls. Ideal for Circadian Rhythm applications or to create the perfect human centric environment. (Click here for more details)

**OPTICAL**

Modular Optics Available with 15°, 24°, 30°, 36°, 52°, 60° and 70° field interchangeable optics design with 45° cutoff to source.

Top-down flash characteristic for superior glare control. The optics attached directly the light engine to the Trim for complete optical alignment and sufficient efficacy.

**WARRANTY**

Five-year warranty for parts and components. (Labor not included)

**LISTINGS**

c-UL-us - Listed for Wet Location if used with HH6-6501 Trim.

c-UL-us - Listed for Feed Through Wiring.

U.S Patent No. - D685,118S

CP-City of Chicago environmental air (CCEA) marking for plenum applications.

Energy Star and California Title 24 compliant

Optional Black color trim is not ENERGYSTAR certified and won't meet the requirement.

Example: HH6-LED-2000L-DIM10-MVOLT-MD-40K-90-HH6-6501-CL-WH

SERIES	LUMENS	DRIVER	VOLTAGE	CCT	EMERGENCY	TRIM TYPE	REFLECTOR/FLANGE COLORS	
HH6-LED	<input type="checkbox"/> 900L	<input type="checkbox"/> DIM10	<input type="checkbox"/> 120	<input type="checkbox"/> 22K	<input type="checkbox"/> EMG-LED-10W	<input type="checkbox"/> HH6-6501 Flanged Downlight	<input type="checkbox"/> CL-WH <input type="checkbox"/> W-WH <input type="checkbox"/> SHZ-SHZ	
	<input type="checkbox"/> 1200L	<input type="checkbox"/> DIMTR <sup>3 5</sup>	<input type="checkbox"/> 277	<input type="checkbox"/> 27K	<input type="checkbox"/> EMG-LED-20W	<input type="checkbox"/> HH6-6507 Flanged Wall Wash	<input type="checkbox"/> CL-SCH <input type="checkbox"/> MB-WH* <input type="checkbox"/> SHZ-BK	
	<input type="checkbox"/> 1500L	<input type="checkbox"/> LUTH <sup>3</sup>	<input type="checkbox"/> MVOLT	<input type="checkbox"/> 30K	<input type="checkbox"/> INTG-EMG-LED-10W	<input type="checkbox"/> HH6-6577 Flanged Double Wall Wash	<input type="checkbox"/> CL-BK <input type="checkbox"/> MB-BK* <input type="checkbox"/> WT-WH	
	<input type="checkbox"/> 2000L	<input type="checkbox"/> LUT2W <sup>3 5</sup>	<input type="checkbox"/> 347 (DIM10 only)	<input type="checkbox"/> 35K	<input type="checkbox"/> INTG-EMG-LED-20W		<input type="checkbox"/> CL-BZ <input type="checkbox"/> BZ-BK <input type="checkbox"/> WT-WT	
	<input type="checkbox"/> 3000L	<input type="checkbox"/> LUTFB <sup>4</sup>		<input type="checkbox"/> 40K	<input type="checkbox"/> EMG-LED-G2-10W-SDT* Typical lumen output of the luminaire is up to 1000L with EMG-LED-10W option & 2000L with EMG-LED-20W option in emergency mode. Contact the factory for details. <i>Remote mounted installation</i> * Consult Factory for Self Diagnostic		<input type="checkbox"/> SHZ-WH <input type="checkbox"/> BZ-BZ <small>* Black color trim is not ENERGYSTAR certified</small>	
	<input type="checkbox"/> 4000L	<input type="checkbox"/> ELDO10-.1		<input type="checkbox"/> 50K <sup>1</sup>		<input type="checkbox"/> HH6-6535 Polycarbonate "Dead Front" Trim with Tempered Albalite Lens	<b>FLANGE COLORS</b>	
	<input type="checkbox"/> 6000L	<input type="checkbox"/> ELDODALI-.1				<input type="checkbox"/> HH6-6534 Polycarbonate "Dead Front" Trim with Polycarbonate ClearLens	<input type="checkbox"/> WH <input type="checkbox"/> BK <input type="checkbox"/> SHZ	
		<input type="checkbox"/> ELDODMX-.1					<input type="checkbox"/> SCH <input type="checkbox"/> BZ	
		<input type="checkbox"/> BLE						
			<b>OPTICS</b>	<b>CRI</b>	<b>OTHER OPTIONS</b>		<b>TRIMLESS</b>	<b>TRIMLESS FINISH</b>
			<input type="checkbox"/> VWD <sup>70°</sup>	<input type="checkbox"/> 90+	<input type="checkbox"/> CP (Chicago Plenum)		<input type="checkbox"/> HH6-TL-6501 Trimless Downlight	<input type="checkbox"/> CL
			<input type="checkbox"/> WD <sup>60°</sup>	<input type="checkbox"/> 98+ <sup>2</sup>	<input type="checkbox"/> HP (High Performance) <sup>6</sup>		<input type="checkbox"/> HH6-TL-6507 Trimless Wall Wash	<input type="checkbox"/> MB
		<input type="checkbox"/> MWD <sup>52°</sup>					<input type="checkbox"/> SHZ	
		<input type="checkbox"/> MD <sup>36°</sup>					<input type="checkbox"/> WH	
		<input type="checkbox"/> ND <sup>30°</sup>						
		<input type="checkbox"/> SPD <sup>24°</sup>						
		<input type="checkbox"/> NSPD <sup>15°</sup>						
						<b>OPTIONS</b>		
						<input type="checkbox"/> INTG (Reflector shipped with pre-punched hole to accept INTG-EMG-LED)		

<sup>1</sup> 50K series are available with 85+ CRI only <sup>2</sup> 98+ CRI is available in 27K, 30K and 40K only **-Reference last page for Control Options**  
<sup>3</sup> LUTH and LUT2W, DIMTR Available for luminaires up to 4000L <sup>4</sup> LUTFB Available for luminaires up to 1500L <sup>5</sup> DIMTR and LUT2W are available in 120V only <sup>6</sup> 3500K and 4000K based on 90CRI

**HH6-LED-4000L-DIM10-MVOLT-MD-40K-90-HH6-6501-CL-WH**

TEST NO.: **EL05112270**

INPUT WATTS: **38.7**      LUMENS: **4576**      EFFICACY: **118**      BEAM ANGLE: **34**      SPACING CRITERIA: **0.50**

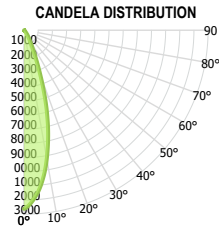

**CANDELA TABLE**

	0°	90°
0°	12618	12618
10°	9225	9999
20°	3340	4245
30°	738	925
40°	207	265
50°	72	93
60°	10	14
70°	0	0
80°	0	0
90°	0	0

**LUMINANCE (cd/sq.m)**

	0.00°	90.00°
0.00°	480355	480355
45.00°	6651	8234
55.00°	1872	2742
65.00°	211	223
75.00°	106	115
85.00°	35	39

**LUMENS PER ZONE**

ZONE	LUMENS
0° - 10°	1081
10° - 20°	1990
20° - 30°	1000
30° - 40°	334
40° - 50°	122
50° - 60°	41
60° - 70°	0
70° - 80°	0
80° - 90°	0

**ZONAL LUMEN SUMMARY**

ZONE	UMENS	% LUMINAIRE
0° - 20°	3070	67%
0° - 30°	4070	89%
0° - 40°	4404	96%
0° - 60°	4568	100%
0° - 80°	4573	100%
0° - 90°	4574	100%

**CONE OF LIGHT**

MOUNTING HEIGHT	FC AT BEAM CENTER	BEAM DIA. 0°-180°	BEAM DIA. 90°-270°
6.0 ft	350.5 fc	3.6 ft	3.6 ft
8.0 ft	197.2 fc	4.8 ft	4.8 ft
10.0 ft	126.2 fc	6.0 ft	6.0 ft
12.0 ft	87.6 fc	7.3 ft	7.2 ft
14.0 ft	64.4 fc	8.5 ft	8.4 ft
16.0 ft	49.3 fc	9.7 ft	9.6 ft
18.0 ft	38.9 fc	10.9 ft	10.8 ft
20.0 ft	31.5 fc	12.1 ft	12.0 ft

**INDOOR COEFFICIENTS OF UTILIZATION**

pf	20%																0%				
	80%				70%				50%				30%					10%			
pc	70%	50%	30%	10%	70%	50%	30%	10%	70%	50%	30%	10%	70%	50%	30%	10%	70%	50%	30%	10%	0%
pw	119	119	119	119	116	116	116	116	111	111	111	111	106	106	106	102	102	102	102	100	0%
1	114	112	110	108	112	110	108	106	106	104	103	102	101	100	99	98	98	97	95	95	95
2	110	106	103	100	108	104	101	99	101	99	97	98	96	95	96	94	93	91	91	91	91
3	106	101	96	93	104	99	95	92	97	94	91	94	92	90	92	90	88	87	87	87	87
4	102	96	91	88	100	95	90	87	93	89	86	91	88	85	89	86	84	83	83	83	83
5	98	91	87	83	97	90	86	83	89	85	82	87	84	81	86	83	81	79	76	76	76
6	95	87	83	79	93	87	82	79	85	81	78	84	81	78	83	80	77	74	73	73	73
7	91	84	79	76	90	83	79	75	82	78	75	81	77	75	80	77	74	71	69	68	68
8	88	80	76	72	87	80	75	72	79	75	72	78	74	72	77	74	71	68	66	65	65
9	85	77	73	70	84	77	72	69	76	72	69	75	72	69	75	71	69	66	64	63	63
10	82	75	70	67	82	74	70	67	74	69	67	73	69	66	72	69	66	63	61	60	60

**HH6-LED-4000L-DIM10-MVOLT-MWD-40K-90-HH6-6501-CL-WH**

TEST NO.: **EL05112270**

INPUT WATTS: **38.8**      LUMENS: **4110**      EFFICACY: **106**      BEAM ANGLE: **55**      SPACING CRITERIA: **0.81**

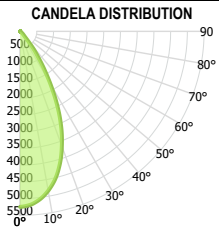

**CANDELA TABLE**

	0°	90°
0°	5246	5246
10°	4838	4975
20°	3649	3917
30°	1808	2107
40°	338	509
50°	75	83
60°	8	13
70°	0	0
80°	0	0
90°	0	0

**LUMINANCE (cd/sq.m)**

	0.00°	90.00°
0.00°	199717	199717
45.00°	7686	8369
55.00°	1766	2428
65.00°	250	289
75.00°	149	179
85.00°	52	83

**LUMENS PER ZONE**

ZONE	LUMENS
0° - 10°	488
10° - 20°	1258
20° - 30°	1393
30° - 40°	758
40° - 50°	166
50° - 60°	38
60° - 70°	0
70° - 80°	0
80° - 90°	0

**ZONAL LUMEN SUMMARY**

ZONE	UMENS	% LUMINAIRE
0° - 20°	1746	42%
0° - 30°	3139	76%
0° - 40°	3897	95%
0° - 60°	4101	100%
0° - 80°	4107	100%
0° - 90°	4108	100%

**CONE OF LIGHT**

MOUNTING HEIGHT	FC AT BEAM CENTER	BEAM DIA. 0°-180°	BEAM DIA. 90°-270°
6.0 ft	145.7 fc	6.3 ft	6.2 ft
8.0 ft	82.0 fc	8.4 ft	8.3 ft
10.0 ft	52.5 fc	10.5 ft	10.4 ft
12.0 ft	36.4 fc	12.6 ft	12.5 ft
14.0 ft	26.8 fc	14.6 ft	14.5 ft
16.0 ft	20.5 fc	16.7 ft	16.6 ft
18.0 ft	16.2 fc	18.8 ft	18.7 ft
20.0 ft	13.1 fc	20.9 ft	20.8 ft

**INDOOR COEFFICIENTS OF UTILIZATION**

pf	20%																0%				
	80%				70%				50%				30%					10%			
pc	70%	50%	30%	10%	70%	50%	30%	10%	70%	50%	30%	10%	70%	50%	30%	10%	70%	50%	30%	10%	0%
pw	119	119	119	119	116	116	116	116	111	111	111	111	106	106	106	102	102	102	102	100	0%
1	114	111	109	107	111	109	107	105	105	103	102	101	100	99	98	97	96	94	94	94	94
2	108	104	100	97	106	102	98	96	99	96	93	96	93	91	93	91	90	88	88	88	88
3	103	97	92	89	101	96	91	88	93	89	86	91	88	85	88	86	84	82	82	82	82
4	98	91	86	82	96	90	85	81	88	84	80	86	82	79	84	81	78	77	77	77	77
5	94	86	80	76	92	85	79	76	83	78	75	81	77	74	80	76	74	72	72	72	72
6	89	81	75	71	88	80	74	71	78	74	70	77	73	70	76	72	69	68	68	68	68
7	85	76	70	66	84	75	70	66	74	69	66	73	69	65	72	68	65	64	64	64	64
8	81	72	66	62	80	71	66	62	70	65	62	69	65	62	68	64	61	60	60	60	60
9	77	68	62	59	76	68	62	58	67	62	58	66	61	58	65	61	58	57	57	57	57
10	74	65	59	55	73	64	59	55	63	58	55	63	58	55	62	58	55	54	54	54	54

**HH6-LED-4000L-DIM10-MVOLT-NSPD-40K-90-HH6-6501-CL-WH**

TEST NO.: **EL05112270**

INPUT WATTS: **38.6**      LUMENS: **3986**      EFFICACY: **103**      BEAM ANGLE: **19**      SPACING CRITERIA: **0.26**

**CANDELA DISTRIBUTION**

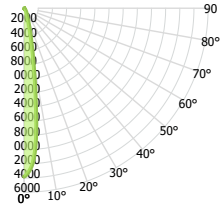

**CANDELA TABLE**

	0°	90°
0°	23792	23792
10°	7538	10215
20°	1485	1942
30°	596	690
40°	202	250
50°	62	73
60°	9	14
70°	0	0
80°	0	0
90°	0	0

**LUMINANCE (cd/sq.m)**

	0.00°	90.00°
0.00°	905757	905757
45.00°	5537	6698
55.00°	1777	2295
65.00°	187	208
75.00°	90	110
85.00°	31	35

**LUMENS PER ZONE**

ZONE	LUMENS
0° - 10°	1691
10° - 20°	1327
20° - 30°	535
30° - 40°	283
40° - 50°	108
50° - 60°	35
60° - 70°	0
70° - 80°	0
80° - 90°	0

**ZONAL LUMEN SUMMARY**

ZONE	LUMENS	% LUMINAIRE
0° - 20°	3018	76%
0° - 30°	3553	89%
0° - 40°	3836	96%
0° - 60°	3979	100%
0° - 80°	3984	100%
0° - 90°	3984	100%

**CONE OF LIGHT**

MOUNTING HEIGHT	FC AT BEAM CENTER	BEAM DIA. 0°-180°	BEAM DIA. 90°-270°
6.0 ft	660.9 fc	2.0 ft	2.0 ft
8.0 ft	371.8 fc	2.7 ft	2.6 ft
10.0 ft	237.9 fc	3.4 ft	3.3 ft
12.0 ft	165.2 fc	4.1 ft	4.0 ft
14.0 ft	121.4 fc	4.7 ft	4.6 ft
16.0 ft	92.9 fc	5.4 ft	5.3 ft
18.0 ft	73.4 fc	6.1 ft	6.0 ft
20.0 ft	59.5 fc	6.8 ft	6.6 ft

**INDOOR COEFFICIENTS OF UTILIZATION**

pc	20%												10%				0%			
	80%			70%			50%			30%			10%		0%					
pw	70%	50%	30%	10%	70%	50%	30%	10%	50%	30%	10%	50%	30%	10%	50%	30%	10%	0%		
0	119	119	119	119	116	116	116	111	111	111	106	106	106	102	102	102	102	100		
1	115	113	111	109	112	111	109	107	107	105	104	103	102	101	100	99	98	96		
2	111	107	104	102	109	106	103	101	103	100	98	100	98	96	97	96	94	93		
3	107	103	99	96	106	101	98	95	99	96	94	97	94	92	94	93	91	90		
4	104	99	95	91	102	97	94	91	95	92	90	94	91	89	92	90	88	87		
5	101	95	91	88	99	94	90	87	92	89	87	91	88	86	89	87	85	84		
6	98	92	87	84	97	91	87	84	90	86	84	88	85	83	87	85	83	81		
7	95	89	84	82	94	88	84	81	87	83	81	86	83	81	85	82	80	79		
8	93	86	82	79	92	86	82	79	85	81	79	84	81	78	83	80	78	77		
9	90	84	80	77	89	83	79	77	82	79	76	82	78	76	81	78	76	75		
10	88	81	77	75	87	81	77	75	80	77	74	80	77	74	79	76	74	73		

**HH6-LED-4000L-DIM10-MVOLT-ND-40K-90-HH6-6501-CL-WH**

TEST NO.: **EL05112270**

INPUT WATTS: **38.6**      LUMENS: **4575**      EFFICACY: **119**      BEAM ANGLE: **32**      SPACING CRITERIA: **0.42**

**CANDELA DISTRIBUTION**

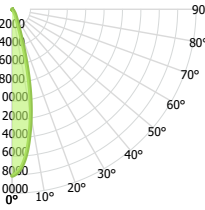

**CANDELA TABLE**

	0°	90°
0°	18099	18099
10°	11695	13524
20°	2196	3060
30°	722	807
40°	254	284
50°	75	84
60°	11	14
70°	0	0
80°	0	0
90°	0	0

**LUMINANCE (cd/sq.m)**

	0.00°	90.00°
0.00°	689034	689034
45.00°	6994	7930
55.00°	2028	2470
65.00°	213	222
75.00°	112	121
85.00°	35	44

**LUMENS PER ZONE**

ZONE	LUMENS
0° - 10°	1475
10° - 20°	1937
20° - 30°	651
30° - 40°	330
40° - 50°	133
50° - 60°	42
60° - 70°	0
70° - 80°	0
80° - 90°	0

**ZONAL LUMEN SUMMARY**

ZONE	LUMENS	% LUMINAIRE
0° - 20°	3411	75%
0° - 30°	4062	89%
0° - 40°	4392	96%
0° - 60°	4567	100%
0° - 80°	4573	100%
0° - 90°	4573	100%

**CONE OF LIGHT**

MOUNTING HEIGHT	FC AT BEAM CENTER	BEAM DIA. 0°-180°	BEAM DIA. 90°-270°
6.0 ft	502.8 fc	2.9 ft	2.8 ft
8.0 ft	282.8 fc	3.8 ft	3.8 ft
10.0 ft	181.0 fc	4.8 ft	4.7 ft
12.0 ft	125.7 fc	5.7 ft	5.7 ft
14.0 ft	92.3 fc	6.7 ft	6.6 ft
16.0 ft	70.7 fc	7.7 ft	7.6 ft
18.0 ft	55.9 fc	8.6 ft	8.5 ft
20.0 ft	45.2 fc	9.6 ft	9.4 ft

**INDOOR COEFFICIENTS OF UTILIZATION**

pc	20%												10%				0%			
	80%			70%			50%			30%			10%		0%					
pw	70%	50%	30%	10%	70%	50%	30%	10%	50%	30%	10%	50%	30%	10%	50%	30%	10%	0%		
0	119	119	119	119	116	116	116	111	111	111	106	106	106	102	102	102	102	100		
1	115	112	110	109	112	110	109	107	106	105	104	103	102	101	99	98	98	96		
2	111	107	104	101	108	105	102	100	102	100	98	99	97	96	96	95	94	92		
3	107	102	98	95	105	100	97	94	98	95	93	96	93	91	93	91	90	88		
4	103	97	93	90	101	96	92	89	94	91	88	92	90	87	91	88	86	85		
5	100	93	89	86	98	92	88	85	91	87	85	89	86	84	88	85	83	82		
6	96	90	85	82	95	89	85	82	88	84	81	86	83	81	85	82	80	79		
7	93	86	82	79	92	86	82	79	85	81	78	84	80	78	83	80	78	76		
8	91	84	79	76	90	83	79	76	82	78	76	81	78	75	80	77	75	74		
9	88	81	76	73	87	80	76	73	80	76	73	79	75	73	78	75	73	72		
10	85	78	74	71	85	78	74	71	77	74	71	77	73	71	76	73	71	70		

**HH6-LED-4000L-DIM10-MVOLT-WD-40K-90-HH6-6501-CL-WH**

TEST NO.: **EL05112270**

INPUT WATTS: **38.5**      LUMENS: **4082**      EFFICACY: **106**      BEAM ANGLE: **65**      SPACING CRITERIA: **0.90**

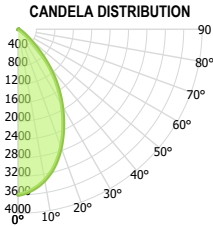

CANDELA TABLE

	0°	90°
0°	3601	3601
10°	3333	3448
20°	2724	2887
30°	1903	2051
40°	1032	1152
50°	281	335
60°	41	52
70°	0	0
80°	0	0
90°	0	0

LUMINANCE (cd/sq.m)

	0.00°	90.00°
0.00°	137096	137096
45.00°	31651	36489
55.00°	8079	9507
65.00°	986	993
75.00°	459	484
85.00°	144	135

LUMENS PER ZONE

ZONE	LUMENS
0° - 10°	337
10° - 20°	898
20° - 30°	1132
30° - 40°	996
40° - 50°	544
50° - 60°	14
60° - 70°	0
70° - 80°	0
80° - 90°	0

ZONAL LUMEN SUMMARY

ZONE	UMENS	% LUMINAIRE
0° - 20°	1235	30%
0° - 30°	2367	58%
0° - 40°	3363	95%
0° - 60°	4057	100%
0° - 80°	4080	100%
0° - 90°	4081	100%

CONE OF LIGHT

MOUNTING HEIGHT	FC AT BEAM CENTER	BEAM DIA. 0°-180°	BEAM DIA. 90°-270°
6.0 ft	100.0 fc	7.7 ft	7.7 ft
8.0 ft	56.3 fc	10.3 ft	10.2 ft
10.0 ft	36.0 fc	12.8 ft	12.8 ft
12.0 ft	25.0 fc	15.4 ft	15.3 ft
14.0 ft	18.4 fc	18.0 ft	17.9 ft
16.0 ft	14.1 fc	20.5 ft	20.5 ft
18.0 ft	11.1 fc	23.1 ft	23.0 ft
20.0 ft	9.0 fc	25.7 ft	25.6 ft

INDOOR COEFFICIENTS OF UTILIZATION

pf	20%												0%					
	80%			70%			50%			30%								
pc	70%	50%	30%	10%	70%	50%	30%	10%	50%	30%	10%	50%	30%	10%	50%	30%	10%	0%
0	119	119	119	119	116	116	116	111	111	111	106	106	106	102	102	102	100	0%
1	113	110	107	105	110	108	105	103	104	102	100	100	98	97	96	95	94	92
2	107	101	97	93	104	100	96	92	96	93	90	93	91	88	90	88	86	85
3	101	93	88	84	98	92	87	83	89	85	82	87	83	80	85	82	79	77
4	95	86	80	76	93	85	80	75	83	78	74	81	77	73	79	75	72	71
5	89	80	74	69	87	79	73	68	77	72	68	75	71	67	74	70	67	65
6	84	74	68	63	83	73	67	63	72	66	62	70	66	62	69	65	61	60
7	79	69	63	58	78	68	62	58	67	62	57	66	61	57	65	60	57	55
8	75	65	58	54	74	64	58	53	63	57	53	62	57	53	61	56	53	51
9	71	60	54	50	70	60	54	50	59	53	49	58	53	49	57	52	49	48
10	67	57	50	46	66	56	50	46	55	50	46	55	49	46	54	49	46	44

**HH6-LED-4000L-DIM10-MVOLT-SPD-40K-90-HH6-6501-CL-WH**

TEST NO.: **EL05112270**

INPUT WATTS: **38.5**      LUMENS: **4390**      EFFICACY: **114**      BEAM ANGLE: **29**      SPACING CRITERIA: **0.41**

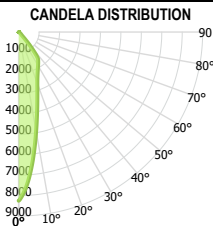

CANDELA TABLE

	0°	90°
0°	8250	8250
10°	4918	5790
20°	2668	2925
30°	1897	2004
40°	845	1167
50°	123	136
60°	39	46
70°	0	0
80°	0	0
90°	0	0

LUMINANCE (cd/sq.m)

	0.00°	90.00°
0.00°	314092	314092
45.00°	10848	13237
55.00°	4866	5380
65.00°	886	832
75.00°	437	424
85.00°	135	114

LUMENS PER ZONE

ZONE	LUMENS
0° - 10°	660
10° - 20°	1130
20° - 30°	1084
30° - 40°	1063
40° - 50°	348
50° - 60°	8
60° - 70°	0
70° - 80°	0
80° - 90°	0

ZONAL LUMEN SUMMARY

ZONE	UMENS	% LUMINAIRE
0° - 20°	1789	41%
0° - 30°	2873	65%
0° - 40°	3937	94%
0° - 60°	4365	100%
0° - 80°	4388	100%
0° - 90°	4388	100%

CONE OF LIGHT

MOUNTING HEIGHT	FC AT BEAM CENTER	BEAM DIA. 0°-180°	BEAM DIA. 90°-270°
6.0 ft	229.2 fc	3.1 ft	3.0 ft
8.0 ft	128.9 fc	4.1 ft	4.0 ft
10.0 ft	82.5 fc	5.1 ft	5.0 ft
12.0 ft	57.3 fc	6.2 ft	6.0 ft
14.0 ft	42.1 fc	7.2 ft	7.0 ft
16.0 ft	32.2 fc	8.2 ft	8.0 ft
18.0 ft	25.5 fc	9.2 ft	9.0 ft
20.0 ft	20.6 fc	10.3 ft	10.0 ft

INDOOR COEFFICIENTS OF UTILIZATION

pf	20%												0%					
	80%			70%			50%			30%								
pc	70%	50%	30%	10%	70%	50%	30%	10%	50%	30%	10%	50%	30%	10%	0%			
0	119	119	119	119	116	116	116	111	111	111	106	106	106	102	102	102	100	0%
1	113	111	108	106	111	109	106	104	104	103	101	101	99	98	97	96	95	93
2	108	103	99	95	106	101	98	94	98	95	92	95	93	90	92	90	88	87
3	102	96	91	87	100	95	90	86	92	88	85	89	86	84	87	85	82	81
4	97	90	84	80	95	88	83	79	86	82	78	84	81	77	82	79	77	75
5	92	84	78	74	91	83	77	73	81	76	73	79	75	72	78	74	71	70
6	88	79	73	68	86	78	72	68	76	71	68	75	71	67	74	70	67	65
7	83	74	68	64	82	73	68	64	72	67	63	71	66	63	70	66	63	61
8	79	70	64	60	78	69	64	60	68	63	59	67	63	59	66	62	59	58
9	76	66	60	56	75	66	60	56	65	60	56	64	59	56	63	59	56	54
10	72	63	57	53	71	62	57	53	61	56	53	61	56	53	60	56	53	51

**HH6-LED-4000L-DIM10-MVOLT-VWD-40K-90-HH6-6501-CL-WH**

TEST NO.: **EL05112270**

INPUT WATTS: **38.6**

LUMENS: **3979**

EFFICACY: **103**

BEAM ANGLE: **74**

SPACING CRITERIA: **1.06**

**CANDELA DISTRIBUTION**

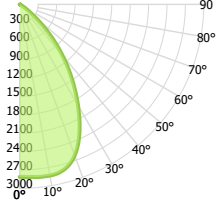

**CANDELA TABLE**

	0°	90°
0°	2813	2813
10°	2833	2805
20°	2619	2639
30°	1899	2009
40°	1077	1199
50°	340	440
60°	39	57
70°	6	7
80°	0	0
90°	0	0

**LUMINANCE (cd/sq.m)**

	0.00°	90.00°
0.00°	107095	107095
45.00°	36820	43347
55.00°	8980	11859
65.00°	973	1122
75.00°	444	528
85.00°	122	157

**LUMENS PER ZONE**

ZONE	LUMENS
0° - 10°	270
10° - 20°	788
20° - 30°	1097
30° - 40°	997
40° - 50°	617
50° - 60°	184
60° - 70°	20
70° - 80°	1
80° - 90°	0

**ZONAL LUMEN SUMMARY**

ZONE	LUMENS	% LUMINAIRE
0° - 20°	1058	27%
0° - 30°	2155	54%
0° - 40°	3152	89%
0° - 60°	3953	100%
0° - 80°	3977	100%
0° - 90°	3977	100%

**CONE OF LIGHT**

MOUNTING HEIGHT	FC AT BEAM CENTER	BEAM DIA. 0°-180°	BEAM DIA. 90°-270°
6.0 ft	78.1 fc	9.1 ft	9.1 ft
8.0 ft	44.0 fc	12.1 ft	12.1 ft
10.0 ft	28.1 fc	15.1 ft	15.1 ft
12.0 ft	19.5 fc	18.1 ft	18.1 ft
14.0 ft	14.4 fc	21.1 ft	21.2 ft
16.0 ft	11.0 fc	24.2 ft	24.2 ft
18.0 ft	8.7 fc	27.2 ft	27.2 ft
20.0 ft	7.0 fc	30.2 ft	30.3 ft

**INDOOR COEFFICIENTS OF UTILIZATION**

pf pc pw	20%																0%		
	80%				70%				50%				30%				10%	0%	
	70%	50%	30%	10%	70%	50%	30%	10%	50%	30%	10%	50%	30%	10%	50%	30%	10%	10%	0%
0	119	119	119	119	116	116	116	116	111	111	111	106	106	106	102	102	102	102	100
1	113	110	107	104	110	107	105	103	103	101	100	100	98	97	96	95	94	92	
2	106	101	96	92	104	99	95	91	96	92	89	93	90	87	90	87	85	84	
3	100	92	87	82	98	91	86	82	88	84	80	86	82	79	84	80	78	76	
4	94	85	79	74	92	84	78	74	82	77	73	80	75	72	78	74	71	69	
5	88	79	72	67	86	78	71	67	76	70	66	74	69	65	72	68	65	63	
6	83	73	66	61	81	72	65	61	70	64	60	69	64	60	67	63	59	58	
7	78	67	60	56	76	67	60	56	65	59	55	64	59	55	63	58	55	53	
8	73	63	56	51	72	62	56	51	61	55	51	60	54	51	59	54	50	49	
9	69	58	52	47	68	58	51	47	57	51	47	56	51	47	55	50	47	45	
10	65	55	48	44	64	54	48	44	53	47	44	52	47	43	52	47	43	42	

- 1- Luminaire will be shipped with Powerpacks pre-installed, ready to be integrated to designated control systems
- 2- Luminaire will be shipped with Sensors installed on the luminaire, allowing for individual luminaire control. Luminaires will be ready to be integrated with designated control systems
- 3- Luminaire will be shipped with Sensors to be remotely installed on the ceiling. Luminaires will be ready to be integrated with designated control systems

BRAND	EASYFIT <small>by EnOcean</small>	LUTRON	enlighted	LEVITON®	OSRAM	PHILIPS <small>EasySense</small>	legrand®
CONTROL UNIT	<input type="checkbox"/> LEDRU LED Relay Zone Controller 0-10V <sup>1</sup>  <input type="checkbox"/> LEDDU LED Zone Controller 0-10V <sup>1</sup>	<input type="checkbox"/> FCJS-010 Lutron Vive 0-10V Individual Pow Pak (Luminaire is shipped Vive Enabled) <sup>14</sup>  <input type="checkbox"/> A-WN-D01-RF-WH Athena wireless node (RF only)	<input type="checkbox"/> CU-4E-FMH Fixture Mount Control Unit <sup>15</sup>	<input type="checkbox"/> ZL027 –NOW Intellect Power Control Module <sup>16</sup>  <input type="checkbox"/> ZL027 –NOW Intellect Power Control Module <sup>16</sup>	<input type="checkbox"/> EN-WCM2-ZB-DR Wireless Control Module <sup>17</sup>  <input type="checkbox"/> EN- ALC-ZB-BK-DR Wireless Area Lighting Control Module <sup>17</sup>  <input type="checkbox"/> ZBHA-CLM-DIM-ENC Connected Lighting Module DIM <sup>17</sup>	<input type="checkbox"/> SBR -BS Xitanium SR Bridge <sup>18</sup>	<input type="checkbox"/> LMFC-011 ON/OFF/0-10V dimming fixture controller <sup>19</sup>  <input type="checkbox"/> LMFS-601 Integrated Fixture Sensor & Controller
INTEGRAT SENSOR	N/A	N/A	N/A	N/A	N/A	N/A	N/A
*WIRELESS OCCUPANCY SENSOR	<input type="checkbox"/> EOSCU-W-E0 Occupancy Sensor - Ceiling Mounted <b>(Must be specified with LEDRU or LEDDU control unit)<sup>3</sup></b>	N/A	N/A	N/A	N/A	N/A	<input type="checkbox"/> LMDC-100 Dual technology PIR Ceiling Mount Occupancy Sensor <sup>3</sup>
*WIRELESS DAYLIGHT SENSOR	<input type="checkbox"/> ELLSU-W-E0 Light Level Sensor - Ceiling Mounted <b>(Must be specified with LEDRU or LEDDU control unit)<sup>3</sup></b>	N/A	N/A	N/A	N/A	N/A	<input type="checkbox"/> LMLS-400 Single zone switching and dimming digital photosensor <sup>3</sup>
*WIRELESS OCCUPANCY & DAYLIGHT SENSOR	N/A	N/A	<input type="checkbox"/> SU-5E-IoT IoT Node Micro Sensor <sup>3</sup> <input type="checkbox"/> SU-5E-CL Connected Lighting Micro Sensor <sup>3</sup> <input type="checkbox"/> SU-5E-IL Independent Lighting / Enlighted One Micro Sensor <sup>3</sup> <input type="checkbox"/> SU-5S-H-(IoT/CL/IL) Surface Mount Sensor <sup>3</sup>  <b>(Must be specified with CU 4E-FMH Control Unit)</b>	<input type="checkbox"/> ZL00J -TOW Intellect Intelligent Fixture Control System <sup>3</sup>  <b>(Must be specified with ZL027 –NOW Control Unit)</b>	<input type="checkbox"/> EN-CLM-PIR-DD-ZB SensiLUM™ Wireless Integrated Sensor <input type="checkbox"/> EN-SCPPH-1500-ZB Wireless Passive Infrared Occupancy and Photo Sensors <sup>3</sup>  <b>(Must be specified with EN-WCM2-ZB-DR or EN- ALC-ZB-BK-DR Control Unit)</b>	<input type="checkbox"/> SNS200- CMP SNS200 for grouping <sup>3</sup>	<input type="checkbox"/> LMFS-601 DLM Fixture Sensor and Controller, Occupancy, Daylight Harvesting, and IPv6/Bluetooth® Low Energy Technology
ACCESSORIES	N/A	N/A	<input type="checkbox"/> TMC-SU-5E Tile Mount Carrier <input type="checkbox"/> CBL-5E-CU4-30N 30 inch Sensor Cable for CU-4 and IoT Ready™ drivers <input type="checkbox"/> CBL-5E-CU4-7F 7 foot Sensor Cable for CU-4 and IoT Ready™ drivers	N/A	N/A	N/A	N/A
NOTES	N/A	4- Luminaire will be compatible with Lutron LRF2-OCR2B-P-WH Ceiling mount 360° occupancy/vacancy sensor & LRF2-DCRB-WH Ceiling-mount daylight sensor. Sensors must be ordered through Lutron.	5- Luminaire will be compatible with ENLIGHTED SU-5E-IoT, SU-5E-CL, SU-5E-IL, SU-5S-H, Sensors.	6-Luminaire will be compatible with Leviton Intellect App & Keypad Room Controller	7-Luminaire will be compatible with EN-SCPPH-1500-ZB Wireless Passive Infrared Occupancy and Photo Sensors	8-Luminaire will be compatible with Philips field and wireless switch.	9-Luminaire will be compatible with DLM Room control system LMPB-100. DLM control system must be orderd through Legrand.