



115 JAMES DRIVE W. SUITE 100 SAINT ROSE, LA 70087
TELEPHONE: (504) 471-0917 FAX: (504) 471-0924

SHOP DRAWING / SUBMITTAL REVIEW

- REVIEWED REVIEWED AS NOTED
 REVISE AND RESUBMIT REJECTED

Project No.: 6584 Submittal No.: 1

Corrections or comments made on the shop drawings during this review do not relieve the contractor from compliance with requirements of the drawings and specifications. This check is only for review of the general conformance with the design concept of the project and general compliance with the information given in the contract documents. This contractor is responsible for: confirming and correlating all quantities and dimensions; selecting fabrication processes and techniques of construction; coordinating his or her work with that and other trades and performing all in a safe and satisfactory manner.

By: Chuck Dammon Date: 04-16-26

DAMMON ENGINEERING, INC.
Slidell, LA



FIRE ALARM submittal

I-10 S. SERVICE ROAD MIXED USED BLDG

I-10 SERVICE ROAD SOUTH, METAIRIE LA 70001

Date:04/13/2026

ADS Job# 6584

DESIGNED BY: WAYNE GUILLOT JR

SOLD BY: WAYNE LEVET



SECTION 1
Equipment List

SECTION 2
Data Sheets & Uls

SECTION 3
Battery Calculations

MIXED USED BLDG
METAIRIE, LA
ADS# 6584FA

6584 MIXED USED BLDG
FIRE ALARM EQUIPMENT LIST

<u>QTY</u>	<u>MODEL</u>	<u>DESCRIPTION</u>
01	NFW-100X	NOTIFIER INTELLIGENT FIRE ALARM CONTROL PANEL
01	HPF-PS10B	NOTIFIER POWER SUPPLY
31	NOT-BG12LX	NOTIFIER ADDRESSABLE PULL STATION
06	NP-200	ADDRESSABLE SMOKE DETECTOR
02	NH-200	ADDRESSABLE HEAT DETECTOR
08	B300-6	6" BASE FOR SMOKE DETECTOR
02	NMM-100P	ADDRESSABLE MINI MONITOR MODULE
01	NC-100	ADDRESSABLE CONTROL MODULE
06	NC-100R	ADDRESSABLE RELAY MODULE
02	R-10E	MULTI VOLTAGE RELAY
19	P2WLED	SYSTEM SENSOR WALL MOUNT SPEAKER STROBE WHITE
09	P2WK	SYSTEM SENSOR WALL MOUNT WEATHERPROOF HORN STROBE WHITE
20	SWLED	SYSTEM SENSOR WALL MOUNT STROBE WHITE
02	IM-12120	12AH BATTERIES
02	IM-12180	18 AH BATTERIES

NFW-100X Intelligent Addressable FACP with Communicator

The **FireWarden-100X (NFW-100X)** is the latest intelligent addressable Fire Alarm Control Panel (FACP) within the FireWarden Series and is a direct replacement for the FireWarden-100 (NFW-100). The NFW-100X comes with a pre-installed communicator and supports up to 198 addressable devices (99 detectors and 99 modules). With an extensive list of powerful features, the NFW-100X programs just like FireWarden-100 products, yet fits into applications previously served only by conventional panels.

The pre-installed IPOTS-COM is a dual technology (POTS and IP) communicator. The POTS transmits system status (alarms, troubles, AC loss, etc.) to a Central Station via the public switched telephone network. The IP communicator's internet monitoring capability sends alarm signals over the Internet saving the monthly cost of two dedicated business telephone lines. Although not required, the secondary telephone line may be retained providing backup communication over the public switched telephone line. Optional cellular reporting is available using the CELL-MOD or CELL-CAB-N.

Remote and local programming of the control panel is possible using the FS-Tools Upload/Download utility. Programming databases can be uploaded/downloaded via the panel's USB port (and USB cable) or via an ethernet connection using the IPOTS-COM communicator. The USB port also allows for the download or upload of the entire program, history file, walk-test data, current status and system voltages by means of a USB flash drive.

The power supply and all electronics are contained on a circuit board supported on a new quick install chassis and housed in a metal cabinet. Available accessories include local and remote upload/download software, remote annunciators, and reverse polarity/city box transmitter (4XTM).

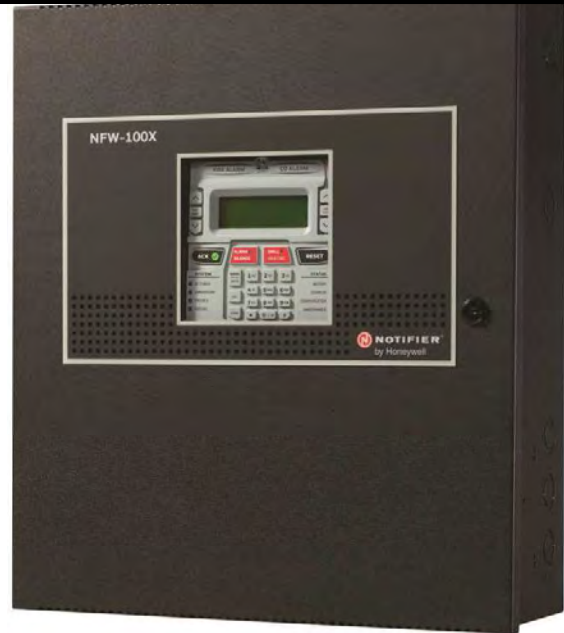

- Listed to UL Standard 864, 10th edition
- Pre-installed IPOTS-COM Ethernet IP and POTS (Plain Old Telephone Service) Central Station Communicator over AlarmNet
- Optional CELL-MOD or CELL-CAB-N GSM Central Station Communicator over AlarmNet®
- Automated activation of the NFC-50/100 Emergency Command Center
- NFC-FFT Firefighter Telephone option
- Compatible with SWIFT® wireless devices
- Auto-programming (learn mode) reduces installation time. Reports two devices set to the same address
- Four built-in, independently programmable Style Z (Class A) or Style Y (Class B) NAC circuits
- Selectable strobe synchronization for System Sensor, Wheelock, and Gentex devices
- Notification Appliance Circuit End of Line resistor matching
- Four programmable function keys for ease of maintenance
- Two programmable relays and one fixed trouble relay
- Built-in Programmer
- Integral 80-character LCD display with backlighting
- Real-time clock/calendar with automatic daylight savings control
- History file with 1,000 event capacity
- Addressable sounder base compatibility
- Control module delay timer
- Automatic detector sensitivity testing (NFPA 72 compliant)
- Automatic device type-code verification
- Point trouble identification
- Waterflow selection per module point
- Alarm verification selection per detector point

- Maintenance alert warns when smoke detector dust accumulation is excessive
- One-person audible or silent walk test with walk-test log and printout
- System alarm verification selection per detector point
- PAS (Positive Alarm Sequence) and Pre-signal per point (NFPA 72 compliant)

- Up to 16 ANN-BUS annunciators- 8 per each ANN-Bus
- Remote Acknowledge, Alarm Silence, Reset and Drill via addressable modules or remote annunciator
- Upload/Download of program and data via USB with optional FS-Tools Programming Utility

SLC COMMUNICATION LOOP

- Supports FlashScan® and CLIP protocols
- SLC operates up to 10,000 ft. (3,000 m) in FlashScan mode with twisted, unshielded wire
- Single addressable SLC loop which meets NFPA Class B and Class A requirements
- 198 addressable device capacity (99 addressable detectors and 99 modules)
- Compatible with NOTIFIER FireWarden and ONYX Series addressable devices (refer to the *FireWarden SLC Wiring Manual*)

NOTIFICATION APPLIANCE CIRCUITS (NACS)

- Four independently programmable output circuits. Circuits can be configured for the following outputs:
 - Style Y (Class B)
 - Style Z (Class A)
 - Silence Inhibit and Autosilence timer options
 - Continuous, March Time, Temporal, or California code for main circuit board NACs with two-stage capability
 - Selectable strobe synchronization per NAC
 - 2.5 A special application, 250mA regulated, total power for NACs
- NOTE:** Maximum or total 24VDC system power shared between all NAC circuits and the ANN-BUS is 2.7 A

PROGRAMMING AND SOFTWARE

- Autoprogramming (learn mode) reduces installation time
- Custom English labels (per point) may be manually entered or selected from an internal library file
- Two programmable Form-C relay outputs
- 99 software zones
- Continuous fire protection during online programming
- Program Check automatically catches common errors not linked to any zone or input point
- **OFFLINE PROGRAMMING:** Create the entire program in your office using FS-Tools, a Windows®-based software package, and upload/download system programming locally. Offline programming requires an ethernet connection. FS-Tools is available on www.notifier.com.

LED INDICATORS

- Fire Alarm (red)
- AC Power (green)
- Trouble (yellow)
- Battery fault (yellow)
- Maintenance (yellow)
- Alarm Silenced (yellow)
- CO Alarm (red)
- Supervisory (yellow)
- Ground fault (yellow)
- Disabled (yellow)
- Communication (yellow)
- F1-F4 Programmable Function Keys (yellow)

KEYPAD

- 16 key alpha-numeric pad
- Alarm Silence
- Four (4) programmable function keys
- Acknowledge
- Drill (Manual Evacuate)
- Reset (lamp test)

PRODUCT LINE INFORMATION

NFW-100X: Addressable Fire Alarm Control Panel with one SLC loop. Includes main circuit board with display chassis with transformer, backbox with door, plastic bag containing screws, cables, key, etc.

FS-Tools: Programming software for Windows®-based PC computer. Available for download at www.notifier.com.

CELL-CAB-N/CELL-MOD: Optional GSM communicators.

IPOTS-COM: Dual technology (POTS and IP) communicator. (replacement board)

DP-ES-R: Optional dress panel for the NFW-100X (red).

DP-ES-B: Optional dress panel for NFW-100X (black).

TR-CE-B: Optional trim ring for semi-flush mounting. (Black. For red, order **TR-CE**.)

BB-XP: Optional cabinet for one or two modules.

BB-25: Optional cabinet for up to six modules mounted on CHS-6 chassis.

BB-26: Battery backbox, holds up to two 25 AH batteries and CHG-75.

NFS-LBB: Battery box, houses two 55 AH batteries

CHS-6: Chassis, mounts up to six multi-modules in a BB-25 cabinet.

CHG-75: Battery charger for lead-acid batteries with a rating of 25 to 75 AH.

CHG-120: Remote battery charging system for lead-acid batteries with a rating of 55 to 120 AH. Requires additional NFS-LBB for mounting.

NOTE: CHG-120 or CHG-75 required for batteries larger than 18AH.

BAT Series: Batteries, see data sheet DN-6933.

PRN Series: UL listed compatible event printer. Uses tractor-fed paper.

OPTIONAL MODULES

4XTM Reverse Polarity Transmitter Module: Provides a super-

vised output for local energy municipal box transmitter, alarm and trouble. Includes a disable switch and disable trouble LED.

PWRMOD24 Power Expander Module: Optional power module. Increases alarm power output to 6 amps.

COMPATIBLE ANNUNCIATORS

N-ANN-80: Remote LCD annunciator mimics the information displayed on the FACP LCD display. Recommended wire type is unshielded. (Basic model is black; order -W for white; see DN-7114.)

N-ANN-100R: Remote LCD annunciator mimics the information displayed on the FACP LCD display. Recommended wire type is unshielded. For use in FM applications only. (Basic model is black; order R for red.)

N-ANN-I/O: LED Driver Module provides connections to a user supplied graphic annunciator. (See DN-7105.)

N-ANN-LED: Annunciator Module provides three LEDs for each

(See DN-60242.)

N-ANN-RLED: Provides alarm (red) indicators for up to 30 input zones or addressable points. (See DN-60242.)

N-ANN-RLY: Relay Module provides 10 programmable Form-C relays. Can be mounted inside the cabinet. (See DN-7107.)

N-ANN-S/PG: Serial/Parallel Printer Gateway module provides a connection for a serial or parallel printer. (See DN-7103.)

ADDRESSABLE DEVICES

FSP-951: Addressable low-profile photoelectric smoke detector. FlashScan only.

FSP-951-IV: Addressable low-profile photoelectric smoke detector. Ivory. FlashScan and CLIP mode.

NP-200: Addressable low-profile photoelectric smoke detector. B300-6 base included, FlashScan only.

NP-200-IV: Addressable low-profile photoelectric smoke detector. Ivory, B300-6-IV base included. FlashScan and CLIP mode.

FSP-951T: Addressable low-profile photoelectric smoke detector with thermal sensor. FlashScan only.

FSP-951T-IV: Addressable low-profile photoelectric smoke detector with thermal sensor. Ivory. FlashScan and CLIP mode.

NP-200T: Addressable low-profile photoelectric smoke detector with thermal sensor. B300-6 base included. FlashScan only.

NP-200T-IV: Addressable low-profile photoelectric smoke detector with thermal sensor. Ivory, B300-6-IV base included. FlashScan and CLIP mode.

FSP-951R: Remote test capable addressable photoelectric smoke detector for use with DNR(W) duct detector housing. FlashScan only.

FSP-951R-IV: Remote test capable addressable photoelectric smoke detector for use with DNR(W) duct detector housing. Ivory. FlashScan and CLIP mode.

NP-200R: Remote test capable addressable photoelectric smoke detector for use with DNR(W) duct detector housing. FlashScan only.

NP-200R-IV: Remote test capable addressable photoelectric smoke detector for use with DNR(W) duct detector housing. Ivory, FlashScan and CLIP mode.

FST-951: Low-profile 135°F fixed thermal sensor. FlashScan only.

FST-951-IV: Low-profile 135°F fixed thermal sensor. Ivory. FlashScan and CLIP mode.

NH-200: Low-profile 135°F fixed thermal sensor. B300-6 base included, FlashScan only.

NH-200-IV: Low-profile 135°F fixed thermal sensor. Ivory, B300-6-IV base included, FlashScan and CLIP mode.

FST-951R: Low-profile, intelligent, rate-of-rise thermal sensor. FlashScan only.

FST-951R-IV: Low-profile, intelligent, rate-of-rise thermal sensor. Ivory. FlashScan and CLIP mode.

NH-200R: Low-profile 135°F fixed thermal sensor. B300-6 base included, FlashScan only.

NH-200R-IV: Low-profile 135°F fixed thermal sensor. Ivory. B300-6-IV base included, FlashScan and CLIP mode.

FST-951H: Low-profile intelligent 190°F/88°C fixed thermal sensor. FlashScan only.

FST-951H-IV: Low-profile intelligent 190°F/88°C fixed thermal sensor. Ivory. FlashScan and CLIP mode.

NH-200H: Low-profile intelligent 190°F/88°C fixed thermal sensor. B300-6 base included, FlashScan only.

NH-200H-IV: Low-profile intelligent 190°F/88°C fixed thermal sensor. Ivory. B300-6-IV base included, FlashScan and CLIP mode.

Legacy Devices

FSI-851: Addressable low-profile ionization smoke detector.

NI-100: Addressable low-profile ionization smoke detector.

FSP-851: Addressable low-profile photoelectric smoke detector.

NP-100: Addressable low-profile photoelectric smoke detector.

FSP-851T: Addressable low-profile photoelectric smoke detector with thermal sensor.

NP-100T: Addressable low-profile photoelectric smoke detector with thermal sensor.

FSP-851R: Remote test capable addressable photoelectric smoke detector for use with DNR(W) duct detector housing.

NP-100R: Remote test capable addressable photoelectric smoke detector for use with DNR(W) duct detector housing.

FST-851: Fast-response, low-profile heat detector.

NH-100: Fast-response, low-profile heat detector.

FST-851R: Fast-response, low-profile heat detector with rate-of-rise option.

NH-100R: Fast-response, low-profile heat detector with rate-of-rise option.

FST-851H: Fast-response, low-profile heat detector that activates at 190°F/88°C.

NH-100H: Fast-response, low-profile heat detector that activates at 190°F/88°C.

FAPT-851: Addressable low-profile multi-sensor detector.

NP-A100: Addressable low-profile multi-sensor detector.

B200S: Programmable, addressable sounder base.

B200SR: Addressable sounder base.

DNR: InnovairFlex low-flow non-relay duct-detector housing. (Order FSP-851R, FSP-951R, or NP-100R separately.)

DNRW: InnovairFlex low-flow non-relay duct-detector housing, with NEMA-4 rating. Watertight. (Order FSP-851R, FSP-951R, or NP-100R separately.)

Addressable Modules

FMM-1: Addressable Monitor Module for one zone of normally-open dry-contact initiating devices. Mounts in standard 4.0" (10.16 cm.) box. Includes plastic cover plate and end-of-line resistor. Module may be configured for either a Style B (Class B) or Style D (Class A) IDC.

NMM-100: Addressable Monitor Module for one zone of normally-open dry-contact initiating devices. Mounts in standard 4.0" (10.16 cm.) box. Includes plastic cover plate and end-of-line resistor. Module may be configured for either a Style B (Class B) or Style D (Class A) IDC.

FDM-1: Dual Monitor Module. Same as NMM-100 except it provides two Style B (Class B) only IDCs.

NDM-100: Dual Monitor Module. Same as NMM-100 except it provides two Style B (Class B) only IDCs.

FMM-101: Miniature version of NMM-100. Excludes LED and Style D option. Connects with wire pigtailed. May mount in device backbox.

NMM-100P: Miniature version of NMM-100. Excludes LED and Style D option. Connects with wire pigtailed. May mount in device backbox.

FZM-1: Similar to NMM-100. Addressable Monitor Module for one

zone of conventional two-wire detectors. Requires resettable 24 VDC power. Refer to the *Device Compatibility Document* for listed compatible devices and quantity limitation.

NZM-100: Similar to NMM-100. Addressable Monitor Module for one zone of conventional two-wire detectors. Requires resettable 24 VDC power. Refer to the *Device Compatibility Document* for listed compatible devices and quantity limitation.

FCM-1: Addressable Control Module for one Style Y/Z (Class B/A) zone of supervised polarized Notification Appliances. Mounts directly to a 4.0" (10.16 cm.) electrical box. NAC option requires external 24 VDC to power notification appliances.

NC-100: Addressable Control Module for one Style Y/Z (Class B/A) zone of supervised polarized Notification Appliances. Mounts directly to a 4.0" (10.16 cm.) electrical box. NAC option requires external 24 VDC to power notification appliances.

FRM-1: Addressable relay module containing two isolated sets of Form-C contacts, which operate as a DPDT switch. Mounts directly to a 4.0" (10.16 cm.) box, surface mount using the SMB500.

NC-100R: Addressable relay module containing two isolated sets of Form-C contacts, which operate as a DPDT switch. Mounts directly to a 4.0" (10.16 cm.) box, surface mount using the SMB500.

NBG-12LX: Addressable manual pull station with interface module mounted inside.

NOT-BG12LX: Addressable manual pull station with interface module mounted inside.

ISO-X: Fault Isolator Module.

N100-ISO: Fault Isolator Module.

ISO-6: Six-fault isolator module. Mount one or two modules in a BB-XP cabinet (optional). Mount up to six modules on a CHS-6 chassis in a CAB-3/CAB-4 series cabinet.

SMB500: Used to mount all modules except the FMM-101/NMM-100P.

NMM-100-10: Ten-input monitor module. Mount one or two modules in a BB-2F cabinet (optional). Mount up to six modules on a CHS-6 chassis in a BB-6F cabinet.

NZM-100-6: Six-zone interface module. Mount one or two modules in a BB-XP cabinet (optional). Mount up to six modules on a CHS-6 chassis in a CAB-3/CAB-4 series cabinet.

SWIFT Wireless Devices

FWSG: Wireless Gateway

FWD-200P: intelligent, wireless photo detector.

FWH-200ROR135: LiteSpeed intelligent wireless rate of rise (135°) heat detector.

FWD-200ACCLIMATE: Wireless Acclimate Detector

FWH-200FIX135: intelligent wireless fixed-temperature (135°) heat detector.

FW-MM: Intelligent wireless monitor module.

FW-RM: Intelligent wireless relay module.

NBG-12LW: Intelligent wireless pull station.

WAV-RL, WAV-WL, WAV-CRL, WAV-CWL: Intelligent AV bases.

W-USB: Wireless USB radio/antenna dongle that plugs into the USB port of a PC running SWIFT Tools.

SWIFT Tools: Programming and diagnostic utility for the Wireless Gateway and devices. Available for download from firelite.com.

NOTE: For more information on Compatible Addressable Devices for use with the FireWarden-100X, see the following data sheets (document numbers): NP-200 Series (DN-60979), NH-200 Series (DN-60980), FSP-851 Series (DN-6935), FSP-951 Series (DN-60977), FST-851 Series (DN-6936), FST-951 Series (DN-60975), FAPT-851 (DN-6937), N100-ISO (DN-6994), NP-100 series (DN-6995), NH-100/NH-100R (DN-6997), DNR/InnovairFlex (DN-60424, DN-60429), NP-A100 (DN-6998), NMM-100/NMM-100P/NDM-100/NZM-100 (DN-6999), NC-100 (DN-7000), NC-100R (DN-60383), NMM-100-10 (DN-6990), MM-1/FDM-1/FZM-1/FMM-101 (DN-6720), FCM-1/FRM-1 (DN-6724), NOT-BG12LX (DN-7001), NBG-12LX (DN-6726), and FireWarden SLC Manual (52304).

SPECIFICATIONS

• Intelligent Signaling Line Circuits.....	1
• Addressable device capacity.....	198
• Programmable software zones.....	99
• Annunciators.....	16

AC Power: Operates in either 120 or 240 VAC, 50/60 Hz, 3.25 A, auto-sensing- no switch required. Wire size: minimum 14 AWG (2.00 mm²) with 600 V insulation. Nonpower-limited, supervised.

Battery: Two 12 V 18 AH lead-acid batteries. Battery Charger Capacity: 7-18 AH (FireWarden-100X cabinet holds maximum of two 18 AH batteries.)

Communication Loop: Supervised and power-limited.

Notification Appliance Circuits: Terminal Block provides connections for four NACs, Style Y (Class B) or Style Z (Class A). Special Application power. Power-limited, supervised circuitry. Maximum signaling current per circuit: 2.5 amps special application, 250mA regulated. End-of-Line Resistor: 4.7k ohm, ½ watt (P/N 71252 UL listed) for Style Y (Class B) NAC; system capable of 1.9 kΩ - 22 kΩ ELR range. Refer to the *NOTIFIER Device Compatibility Document* for listed compatible devices.

Two Programmable Relays and One Fixed Trouble Relay: Contact rating: 2.0 A @ 30 VDC (resistive), 0.5 A @ 30 VAC (resistive). Form-C relays, non-power-limited, non-supervised.

Door: 19.26" (48.92 cm.) high x 16.82" (42.73 cm.) wide x 0.72" (1.82 cm.) deep. **Backbox:** 19.00" (48.26 cm.) high x 16.65" (42.29 cm.) wide x 5.25" (13.34 cm.) deep. **Trim Ring (TR-CE/B):** 22.00" (55.88 cm.) high x 19.65" (49.91 cm.) wide.

Weight: 26.9 lbs. (12.20 kg.) **Dimensions:** 20.00" (50.80 cm.) high x 22.5" (57.15 cm.) wide x 8.5" (21.59 cm.) deep.

This system meets NFPA requirements for operation at 0 – 49°C/32 – 120°F and at a relative humidity 93% ± 2% RH (noncondensing) at 32°C ± 2°C (90°F ± 3°F). However, the useful life of the system's standby batteries and the electronic components may be adversely affected by extreme temperature ranges and humidity. Therefore, it is recommended that this system and its peripherals be installed in an environment with a normal room temperature of 15 – 27°C/60 – 80°F.

End-of-Line Resistor Assembly (R-47K and R-3.9K): The 47k ohm assembly supervises the NMM-100-10, NDM-100, NMM-100P, and NC-100 module circuits. The 3.9k ohm assembly supervises the NZM-100-6 module circuit. These resistors are included with each module.

Power Supervision Relay: Supervises the power to 4-wire smoke

While shielded wire is not required, it is recommended that all SLC wiring be twisted-pair to minimize the effects of electrical interference. Refer to the panel manual for wiring details.

The FireWarden-100X complies with the following NFPA 72 Fire Alarm Systems requirements:

- **LOCAL** (Automatic, Manual, Waterflow and Sprinkler Supervisory).
- **AUXILIARY** (Automatic, Manual and Waterflow) (requires 4XTM).
- **REMOTE STATION** (Automatic, Manual and Waterflow) (Where a DACT is not accepted, the alarm, trouble and supervisory relays may be connected to UL 864 listed transmitters. For reverse polarity signaling of alarm and trouble, 4XTM is required.)
- **PROPRIETARY** (Automatic, Manual and Waterflow).

Sprinkler Supervised).

- **OT, PSDN** (Other Technologies, Packet-switched Data Network)
- **IBC 2012, IBC 2009, IBC 2006, IBC 2003, IBC 2000** (Seismic).
- **CBC 2007** (Seismic)

The listings and approvals below apply to the basic FireWarden-100X control panel. In some cases, certain modules may not be

Consult factory for latest listing status.

- **UL:** S635
- **CSFM:** 7165-0028:0505
- **FDNY:** COA #6268



This document is not intended to be used for installation purposes.
We try to keep our product information up-to-date and accurate.
We cannot cover all specific applications or anticipate all requirements.
All specifications are subject to change without notice.

AlarmNet®, NOTIFIER®, FireWarden®, SWIFT®, and System Sensor® are registered trademarks of Honeywell International Inc. Microsoft® and Windows® are registered trademarks of the Microsoft Corporation.

©2018 by Honeywell International Inc. All rights reserved. Unauthorized use of this document is strictly prohibited.

Country of Origin: USA

NOTIFIER

12 Clintonville Road
Northford, CT 06472
203.484.7161
www.notifier.com





UOJZ.S635 - CONTROL UNITS, SYSTEM

Control Units, System

See General Information for Control Units, System

NOTIFIER

12 Clintonville Rd
Northford, CT 06472-1610 USA

S635

UL 864 10th Edition Listed

Model	Control Unit System Type(s)	Initiating Device Type(s)	Signaling Type(s)
FireWarden-100X	AUX	A, M, WF	Rev Pol
	L	A, CO, M, SS, WF	March, NC, T4
	RS (PPU)	A, CO, M, SS, WF	DAC, PB, Rev Pol
	P (PPU)	A, CO, M, SS, WF	DAC, PB, Rev Pol
	CS (PPU)	A, CO, M, SS, WF	DAC, PB, Rev Pol
FireWarden-50X	AUX	A, M, WF	Rev Pol
	L	A, CO, M, SS, WF	March, NC, T4
	RS (PPU)	A, CO, M, SS, WF	DAC, PB, Rev Pol
	P (PPU)	A, CO, M, SS, WF	DAC, PB, Rev Pol
	CS (PPU)	A, CO, M, SS, WF	DAC, PB, Rev Pol
NFS2-3030 # (f) (c), NFS2-3030E # (f) (c), XLS3000 # (f) (c)	L	A, M, SS, WF	C, NC
	AUX	A, M, WF	NC
	RS (PPU)	A, M, SS, WF	DAC, PB, Rev Pol
	CS (PPU)	A, M, SS, WF	DAC, NC, PB
	P (PPU)	A, M, SS, WF	DAC, MX, NC, PB
NFS2-640 (R) # (g) (c), NFS2-640E (R) (c) # (g) (c), NFS-320 (R) # (g) (c), NFS-320E/C (R) # (g) (c), NFS-320SYS/(E)(-FR) # (g) (c)			
	L	A, M, SS, WF	C, MX, NC
	AUX	A, M, WF	NC
	RS (PPU)	A, M, SS, WF	DAC, PB, Rev Pol

	CS (PPU)	A, M, SS, WF	DAC, MX, NC, PB
	P (PPU)	A, M, SS, WF	DAC, MX, NC, PB
NFW-100X	AUX	A, M, WF	Rev Pol
	L	A, CO, M, SS, WF	March, NC, T4
	RS (PPU)	A, CO, M, SS, WF	DAC, PB, Rev Pol
	P (PPU)	A, CO, M, SS, WF	DAC, PB, Rev Pol
	CS (PPU)	A, CO, M, SS, WF	DAC, PB, Rev Pol
NFW-50X	AUX	A, M, WF	Rev Pol
	L	A, CO, M, SS, WF	March, NC, T4
	RS (PPU)	A, CO, M, SS, WF	DAC, PB, Rev Pol
	P (PPU)	A, CO, M, SS, WF	DAC, PB, Rev Pol
	CS (PPU)	A, CO, M, SS, WF	DAC, PB, Rev Pol

UL 864 9th Edition Listed

Model	Control Unit System Type(s)	Initiating Device Type(s)	Signaling Type(s)
Firewarden-100 (d)	L	A, M, SS, WF	March, NC
	AUX	A, M, WF	NC
	RS (PPU)	A, M, SS, WF	C
	RS (PPU)	A, M, SS, WF	Rev Pol
	RS (PPU)	A, M, SS, WF	DAC, OT
	P (PPU)	A, M, SS, WF	C, DAC, OT
	CS (PPU)	A, M, SS, WF	DAC
Firewarden-100-2 (d), Firewarden 100-2E (d)	L	A, M, SS, WF	March, NC
	AUX	A, M, WF	NC
	RS (PPU)	A, M, SS, WF	C
	RS (PPU)	A, M, SS, WF	Rev Pol

	RS (PPU)	A, M, SS, WF	DAC, OT
	P (PPU)	A, M, SS, WF	C, DAC, OT
	CS (PPU)	A, M, SS, WF	DAC, OT
FireWarden-50 (e), FireWarden-50E (e)	L	A, M, SS, WF	C, March, NC
	AUX	A, M, WF	NC
	RS (PPU)	A, M, SS, WF	DAC, NC, OT, Rev Pol
	P (PPU)	A, M, SS, WF	C, DAC, OT
	CS (PPU)	A, M, SS, WF	DAC, OT
NCS5-W-ONYX, NCS5-F-ONYX	CS, P (RU)	A, M, SS, WF	MX
NFW-100 (d)	L	A, M, SS, WF	March, NC
	AUX	A, M, WF	NC
	RS (PPU)	A, M, SS, WF	C
	RS (PPU)	A, M, SS, WF	Rev Pol
	RS (PPU)	A, M, SS, WF	DAC, OT
	P (PPU)	A, M, SS, WF	C, DAC, OT
	CS (PPU)	A, M, SS, WF	DAC
NFW-50 (e), NFW-50E (e)	L	A, M, SS, WF	C, March, NC
	AUX	A, M, WF	NC
	RS (PPU)	A, M, SS, WF	DAC, NC, OT, Rev Pol
	P (PPU)	A, M, SS, WF	C, DAC, OT
	CS (PPU)	A, M, SS, WF	DAC, OT

NFW2-100 (d), NFW2-100E (d)	L	A, M, SS, WF	March, NC
	AUX	A, M, WF	NC
	RS (PPU)	A, M, SS, WF	C
	RS (PPU)	A, M, SS, WF	Rev Pol
	RS (PPU)	A, M, SS, WF	DAC, OT
	P (PPU)	A, M, SS, WF	C, DAC, OT
	CS (PPU)	A, M, SS, WF	DAC, OT
NSP-25, NSP-25E	AUX	A, M, WF	-
	L	A, M, SS, WF	C, NC
	RS (PPU)	A, M, SS, WF	DAC, OT, Rev Pol
	CS (PPU)	A, M, SS, WF	DAC, OT
RP-1001*	L	A, M, SS, WF	NC
	AUX	A, M, WF	NC
	RS (PPU)	A, M, WF	NC
	RS (PPU)	A, M, WF	DAC
	P (PPU)	A, M, WF	NC
	CS (PPU)	A, M, WF	DAC
RP-1002*, RP-1002E*	L	A, M, SS, WF	NC
	AUX	A, M, WF	NC
	RS (PPU)	A, M, WF	NC
	RS (PPU)	A, M, WF	DAC
	P (PPU)	A, M, WF	NC
	CS (PPU)	A, M, WF	DAC
RP-2001 (2)(h), RP-2001E (2)(h), RP-2002 (2)(h), RP-2002E (2)(h)	L	A, M, SS, WF	March, NC

	AUX	A, M, WF	NC
	RS (PPU)	A, M, SS, WF	DAC, NC, Rev Pol
	P (PPU)	A, M, WF	C, DAC
	CS (PPU)	A, M, SS, WF	DAC
S5000 # (b)	AUX, L, P (PPU), RS (PPU)	A, M, SS, WF	C, NC
	CS (PPU)	A, M, WF	C, DAC, NC
	CS, RS (PPU)	A, M, SS, WF	DAC
	RS (PPU)	SS	Rev Pol
S5000E (b)	CS (PPU)	A, M, WF	C, DAC, NC
	CS, RS (PPU)	A, M, SS, WF	DAC
	RS (PPU)	SS	Rev Pol
SFP-2402 (a)	L	A, M, SS, WF	March, NC
	P (PPU)	A, M, SS, WF	C
	CS (PPU)	A, M, SS, WF	DAC
SFP-2402E (i), SFP-2404E (i)	L	A, M, SS, WF	March, NC
	AUX	A, M, WF	NC
	P (PPU)	A, M, SS, WF	C
	CS (PPU)	A, M, SS, WF	DAC
SFP-2404 (i)	L	A, M, SS, WF	March, NC
	AUX	A, M, WF	NC
	RS (PPU)	A, M, SS, WF	Rev Pol
	P (PPU)	A, M, SS, WF	C
	CS (PPU)	A, M, SS, WF	DAC

SFP-400*(j), SFP-400B*(j)	L	A, M, SS, WF	NC
	AUX	A, M, WF	NC
	RS (PPU)	A, M, SS, WF	Rev Pol
	RS (PPU)	A, M, WF	DAC
	P (PPU)	A, M, WF	NC
	CS (PPU)	A, M, WF	DAC
SFP-5UD (1)(h), SFP-10UD (1)(h), SFP-5UDE (1)(h), SFP-10UDE (1)(h), SFP-10UDC (1)(h), SFP-5UDC (1)(h)			
	L	A, M, SS, WF	March, NC
	AUX	A, M, WF	NC
	RS (PPU)	A, M, SS, WF	DAC, NC, OT, Rev Pol
	CS (PPU)	A, M, SS, WF	DAC, OT
	P (PPU)	A, M, SS, WF	C, DAC, OT
SGL-404	CS (PPU)	A, M, WF	NC
	AUX, L	A, M, SS, WF	NC
	RS (PPU)	A, M, WF	NC
XP Transponder #	L	A, M, WF	NC
	AUX, P (PPU)	A, M, WF	MX, NC

UL 864 10th Edition Listed

Subassembly, Model(s) AMPS-24 Power Supply, AMPS-24E Power Supply, BDA-25V Backup Digital Audio Amplifier, BDA-70V Backup Digital Audio Amplifier, CAB-AA4(n), CPS-24 Power Supply, CPS-24E Power Supply, CPU2-3030D CPU Board with Display, CPU2-640 Central Processing Unit Board, CPU2-640E Central Processing Unit Board, DAA-PS Power Supply, DS-FM, DS-RFM, DS-SFM Fiber Conversion Module, DVC, DVC-EM, DVC-EMF, DVC-EMSF Digital Voice Command, DVC-AO Audio Output Board, DVC-KD Keypad Board, LCM-320 Loop Control Module, LEM-320 Loop Expander Module, NCD Network Control Display, NCM-F, NCM-W Network Control Module, NCM-W Network Control Module, TM-4 Transmitter Module

Subassembly, amplifier, Model(s) AA-100, AA-100E, AA-120, AA-120E, AA-30, AA-30E

Subassembly, backbox, Model(s) SBB-A4(l), SBB-B4(l), SBB-C4(l), SBB-D4(l)

Subassembly, battery holder chassis, Model(s) CHS-BH1

Subassembly, chassis, Model(s) CHS-2D, CHS-4L, CHS-4N, CHS-M2, CHS-M3

Subassembly, door, Model(s) ADDR-B4(l), ADDR-C4(l), ADDR-D4(l), DR-A4(l), DR-AA4, DR-AA4BR, DR-AA4R, DR-B4(l), DR-C4(l), DR-D4(l), DR-PS1, EQDR-B4(l), EQDR-C4(l), EQDR-D4(l)

Subassembly, dress panel, Model(s) ADP-4B, BM-1B, BP-4, BP2-4, DP-1B, DP-DISP, DP-GDIS1, DP-GDIS2, DPA-1, DPA-1A4, DPA-2, DPDW-1B, DPSW-1B, MP-1B, VP-2B

Subassembly, enclosure, Model(s) ABF-1(m), ABF-2(m), ABF-4(l), ABS-1(l), ABS-1T(l), ABS-2(l), ABS-2D(l), ABS-4D(l), ABS-8R, ABS-TD, BB-100, BB-100R, BB-200, BB-200R, BB-UZC, CA-1, CA-2, CAB-A4(l), CAB-B4(l), CAB-C4(l), CAB-D4(l), CAB-PS1, CAB-RP, CAB-RPR, EQBB-B4(l), EQBB-C4(l), EQBB-D4(l), SBB-AA4, SBB-AA4B, SBB-AA4R

Subassembly, microphone chassis, Model(s) CMIC-1

UL 864 9th Edition Listed

Battery Boxes, Model(s) BB-17

Control Unit Subassemblies - Intended for use with compatible control units as described in the control unit installation manual, Model(s) N-CAC-5X (1) class A converter module

Fire Alarm System Enclosures, Model(s) NFS-LBRR

Proprietary System Ancillary Display, Model(s) NWS, NWS-2, NWS-3, ONYXWeb

Subassembly, Model(s) 4XLM LED Interface Module, 4XTM Transmitter Module, 4XZM Zone Relay Module, BacNet-GW-3 Interface, CMIC-RP Microphone, CPU2-3030ND CPU Board without Display, DS-AMP/E Digital Amplifier, DS-DB Distribution Board, DS-XF70V Audio Transformer, DVC-RPU Remote Paging Unit, GW-WEBPORTAL Supplementary Network Bridge, KAPS-24 Power Supply, KDM-R2 Keyboard Display Module, MODBUS-GW Interface, N-WEBPORTAL Supplementary Network Bridge, SK-WEBPORTAL Supplementary Network Bridge, Vesda-HLI-GW Interface

AUX - Auxiliary System

A - Automatic Fire Alarm: thermostats, smoke detectors, etc.

M - Manual Fire Alarm: manually operated boxes

WF - Waterflow Alarm: waterflow switches

Rev Pol - Reverse Polarity

L - Local System

CO - Carbon Monoxide Alarm: carbon monoxide detectors

SS - Supervisory: gate valves, water-level switches, temperature switches, carbon monoxide alarm, residential fire alarm control units, etc.

March - March Time

NC - Noncoded, Steady, Temporal 3 Pattern, etc.

T4 - Temporal 4 Pattern

RS (PPU) - Remote Station System (Protected Premises Unit)

DAC - Digital Alarm Communicator

PB - Performance Based Technologies

P (PPU) - Proprietary System (Protected Premises Unit)

CS (PPU) - Central Station System (Protected Premises Unit)

C - Coded

MX - Multiplex

OT - Other Transmission Technologies

CS - Central Station System

P (RU) - Proprietary System (Supervising Station Receiving Unit)

- When Local (L) Type, System control unit with additional emergency voice communication, emergency telephone communication and paging.

(1) - Models are complementary Listed to FSZI, SYZV and QVAX.

(2) - Models are complementary Listed to FSZI, SYZV and QVAX when the System Type is Local.

(a) - When the Type Signaling is Coded (C) or Digital Alarm Communicator (DAC), see footnote +.

(b) - When Central Station (PPU) Type or Type Signaling is Digital Alarm Communicator (DAC), see footnote +.

(c) - When type signaling is OTHER TECHNOLOGIES, see footnote +

- (d) - When Type Signaling is Digital Alarm Communicator (DAC), Coded (C) or Other Technologies (OT) see footnote +. When Type Signaling is Reverse Polarity - requires separately Listed Model 4XTMF transmitter module.
- (e) - Noncoded (NC) or Coded (C) Type Signaling (except when Type is Local (L) Rev. Pol. Type Signaling, see footnote +.
- (f) - When Type Signaling is Coded (C), Digital Alarm Communicator (DAC) or Reverse Polarity, see footnote +.
- (g) - When Type Signaling is Coded (C), see footnote +.
- (h) - When Type is Auxiliary or Type Signaling is Reverse Polarity- requires separately Listed Model 4XTMF transmitter Module. When the Type is any Protected Premises Unit (PPU) and the Type Signaling is Coded (C), Non Coded (NC) or Digital Alarm Communicator (DAC), see footnote +.
- (i) - When the Type is Auxiliary or the Type Signaling is Coded (C) or Digital Alarm Communicator (DAC), see footnote +.
- (j) - When Type Signaling is Reverse Polarity, see footnote +.
- (l) - May include /R, /F or /B suffix.
- (m) - May include /R, /F, /B or /D suffix.
- (n) - The CAB-AA4 backbox Series is made up of the SBB-AA4, SBB-AA4R, SBB-AA4B, SBB-AA4BR enclosures, and the DR-AA4, DR-AA4B, DR-AA4R, DR-AA4BR Doors.
- * - Protected Premises Unit when installed and interconnected with additional Listed equipment as described in the units installation instructions.
- + - Must be employed with additional specific Listed device(s) as indicated in installation instructions and wiring diagrams to provide indicated type service. The installation instructions for the Other Transmission Technologies transmitter will specify the compatible Notifier control unit model.

Last Updated on 2019-11-13

The appearance of a company's name or product in this database does not in itself assure that products so identified have been manufactured under UL's Follow-Up Service. Only those products bearing the UL Mark should be considered to be Certified and covered under UL's Follow-Up Service. Always look for the Mark on the product.

UL permits the reproduction of the material contained in the Online Certification Directory subject to the following conditions: 1. The Guide Information, Assemblies, Constructions, Designs, Systems, and/or Certifications (files) must be presented in their entirety and in a non-misleading manner, without any manipulation of the data (or drawings). 2. The statement "Reprinted from the Online Certifications Directory with permission from UL" must appear adjacent to the extracted material. In addition, the reprinted material must include a copyright notice in the following format: "© 2020 UL LLC"

The PS Series are independently configurable power supplies, allowing you to pair any input with any output, and feature LED diagnostics for troubleshooting.

The PS Series is a remote power supply line from Honeywell Power Products and is a direct replacement for the HPF-24S6/8. The HPF-PS6 is a 6 amp and the HPF-PS10 is a 10 amp, remote power supply with battery charger that may be connected to any 12 or 24 volt fire alarm control panel (FACP) or used as a standalone power supply. The PS Series provides 24 VDC power for NACs (notification appliance circuits) configured as either Class B or Class A (requires the ZNAC-PS option card) with multiple sync protocol options. The PS Series also provides auxiliary power, constant or resettable, suited for detectors, annunciators, door holders, and other fire alarm system peripherals. The PS Series cabinet can hold two 7 AH or 18 AH batteries and can charge up to 33 AH batteries in a separate cabinet. The HPF-PS6E and HPF-PS10E are models rated for 240V operation.



ORDERING INFORMATION

HPF-PS6: 6.0 A, 120 VAC remote charger power supply in a lockable, metal enclosure, red

HPF-PS6B: 6.0 A, 120 VAC remote charger power supply in a lockable, metal enclosure, black

HPF-PS6E: 6.0 A, 240 VAC remote charger power supply in a lockable, metal enclosure, red

HPF-PS10: 10.0 A, 120 VAC remote charger power supply in a lockable, metal enclosure, red

HPF-PS10B: 10.0 A, 120 VAC remote charger power supply in a lockable, metal enclosure, black

HPF-PS10E: 10.0 A, 240 VAC remote charger power supply in a lockable, metal enclosure, red

ZNAC-PS: Optional Class A converter card, sold separately

TC810N1013: Addressable Control Module for one Class B or Class A zone of supervised, polarized Notification Appliances. Notification Appliance Circuit option requires external 24 VDC to power notification appliances.

TC810R1024: Addressable relay module containing two isolated sets of Form-C contacts, which operate as a DPDT switch

TC809A1059: Addressable Monitor Module for one zone of normally open dry-contact initiating devices. Includes plastic cover plate and end-of-line resistor. Module may be configured for either a Class B or Class A

TC809D1004: Dual Monitor Module. Same as TC809A1059 except it provides two inputs for Class B wiring only

TC822A1010: Provides two monitored inputs and two Form-C relays. Functions in Class B wiring only

XP6-C: Six-circuit supervised control module

XP6-R: Six Form-C relay control module

EOLR-1: 12/24 VDC end-of-line relay for monitoring four-wire smoke detector power

BAT-1270-BP: Battery, 12 volt, 7.0 AH, 5-pack (two required)

BAT-12180-BP: Battery, 12 volt, 18AH, 2-pack

BAT-12330: Battery, 12 volt, 33AH

SEISKIT-MULTI-1: Seismic kit for the PS Series. Includes bracket and hardware for two 7AH or two 18AH batteries.

PRIMARY (AC) POWER

HPF-PS6(B): 120 VAC, 50/60 Hz, 5.0A maximum

HPF-PS10(B): 120VAC, 50/60 Hz, 6.2 A maximum

HPF-PS6E: 240 VAC, 50/60 Hz, 2.7A maximum

HPF-PS10E: 240 VAC, 50/60 Hz, 3.5A maximum

Wire Size: #12-14 AWG with 600 V insulation

COMMAND INPUT CIRCUIT

Trigger Input Voltage: 9 to 32 VDC

Trigger Current: 2.0 mA (16 - 32 V); Per Input: 1.0 mA (9 - 16 V)

RELAY CIRCUITS

Trouble Contact Rating: 4 A at 24 VDC

OUTPUT CIRCUITS

SECONDARY POWER (BATTERY) CHARGING CIRCUIT

PHYSICAL

Dimensions:

50.8H x 36.83W x 8.9D)

Weight: with two 7Ah batteries is 24 pounds (10.9 kg), with two 18 AH batteries is 39 pounds (17.7 kg)

STANDARDS AND CODES

The HPF-PS complies with the following standards:

NFPA 72: National Fire Alarm Code

UL 864: Standard for Control Units for Fire Alarm Systems (NAC expander mode)

UL 1481: Power Supplies for Fire Alarm Systems

AGENCY LISTINGS AND APPROVALS

The listings and approvals apply to the modules specified in this document. In some cases, certain modules or applications may not be listed by certain approval agencies, or listing may be in process. Consult factory for latest listing status.

UL Listed: S24562

CSFM: 7315-1637:0505

FDNY Approved

FM Approved

System Sensor® is a registered trademark of Honeywell

International, Inc. Wheelock™ is a registered trademark of Cooper

Technologies Company. Gentex™ is a registered trademark of Gentex

Corporation. AMSECO® is a registered trademark of Potter

Electric Signal Company, LLC. ANSI® is a registered trademark of the American National Standards

Institute, Inc.

©2021 by Honeywell International Inc. All rights reserved.

Unauthorized use of this document is strictly prohibited.

This document is not intended to be used for installation purposes. We try to keep our product information

up-to-date and accurate. We cannot cover all specific applications or

anticipate all requirements. All specifications are subject to change

without notice.

Honeywell Power Products

12 Clintonville Road
Northford, CT 06472-1610
203.484.7161
www.honeywellpower.com

DH-61094 | C | 03/21
©2021 Honeywell International Inc.

THE
FUTURE
IS
WHAT
WE
MAKE IT

Honeywell

PGWM.S24562 - Control and Communication Equipment

Control and Communication Equipment

[See General Information for Control and Communication Equipment](#)

HONEYWELL INTERNATIONAL INC

S24562

HONEYWELL POWER PRODUCTS DIV

12 CLINTONVILLE RD

NORTHFORD, CT 06472-1610 USA

Power supply expander, Model(s) HPF-PS10, HPF-PS10B, HPF-PS10E, HPF-PS6, HPF-PS6B, HPF-PS6E

Subassembly, Class A converter, Model(s) ZNAC-PS

[Last Updated](#) on 2020-09-24

The appearance of a company's name or product in this database does not in itself assure that products so identified have been manufactured under UL Solutions' Follow - Up Service. Only those products bearing the UL Mark should be considered to be Certified and covered under UL Solutions' Follow - Up Service. Always look for the Mark on the product.

UL Solutions permits the reproduction of the material contained in Product iQ subject to the following conditions: 1. The Guide Information, Assemblies, Constructions, Designs, Systems, and/or Certifications (files) must be presented in their entirety and in a non-misleading manner, without any manipulation of the data (or drawings). 2. The statement "Reprinted from Product iQ with permission from UL Solutions" must appear adjacent to the extracted material. In addition, the reprinted material must include a copyright notice in the following format: "©2023 UL LLC."

NOT-BG12LX**Addressable Manual Pull Station**

Intelligent/Addressable Devices

General

The Notifier NOT-BG12LX is a state-of-the-art, dual-action (i.e., requires two motions to activate the station) pull station that includes an addressable interface for FireWarden series intelligent control panels, and the NSP-25 panel. Because the NOT-BG12LX is addressable, the control panel can display the exact location of the activated manual station. This leads fire personnel quickly to the location of the alarm.

Features

- Maintenance personnel can open station for inspection and address setting without causing an alarm condition.
- Built-in bicolor LED, which is visible through the handle of the station, flashes in normal operation and latches steady red when in alarm.
- Handle latches in down position and the word “ACTIVATED” appears to clearly indicate the station has been operated.
- Captive screw terminals wire-ready for easy connection to SLC loop (accepts up to 12 AWG/3.25 mm² wire).
- Can be surface mounted (with SB-10 or SB-I/O) or semi-flush mounted. Semi-flush mount to a standard single-gang, double-gang, or 4" (10.16 cm) square electrical box.
- Smooth dual-action design.
- Meets ADAAG controls and operating mechanisms guidelines (Section 4.1.3[13]); meets ADA requirement for 5 lb. maximum activation force.
- Highly visible.
- Attractive shape and textured finish.
- Key reset.
- Includes Braille text on station handle.
- Optional trim ring (BG12TR).
- Meets UL 38, Standard for Manually Actuated Signaling Boxes.

Construction

Shell, door, and handle are molded of durable polycarbonate material with a textured finish.

Specifications

- **Shipping Weight:** 9.6 oz. (272.15 g)
- **Normal operating voltage:** 24 VDC.
- **Maximum SLC loop voltage:** 28.0 VDC.
- **Maximum SLC standby current:** 375 μ A.
- **Maximum SLC alarm current:** 5 mA.
- **Temperature Range:** 32°F to 120°F (0°C to 49°C)
- **Relative Humidity:** 10% to 93% (noncondensing)
- **For use indoors in a dry location**

Installation

The NOT-BG12LX will mount semi-flush into a single-gang, double-gang, or standard 4" (10.16 cm) square electrical outlet box, or will surface mount to the model SB-10 or SB-I/O surface backbox. If the NOT-BG12LX is being semi-flush mounted, then the optional trim ring (BG12TR) may be used.



**The NOT-BG12LX
Addressable Manual Pull Station**

The BG12TR is usually needed for semi-flush mounting with 4" (10.16 cm) or double-gang boxes (not with single-gang boxes).

Operation

Pushing in, then pulling down on the handle causes it to latch in the down/activated position. Once latched, the word “ACTIVATED” (in bright yellow) appears at the top of the handle, while a portion of the handle protrudes from the bottom of the station. To reset the station, simply unlock the station with the key and pull the door open. This action resets the handle; closing the door automatically resets the switch.

Each manual station, on command from the control panel, sends data to the panel representing the state of the manual switch. Two rotary decimal switches allow address settings (1 – 99 on NFW2-100/NFW2-100C, 1 – 50 for NFW-50/NFW-50C).

Architectural/Engineering Specifications

Manual Fire Alarm Stations shall be non-coded, with a key-operated reset lock in order that they may be tested, and so designed that after actual Emergency Operation, they cannot be restored to normal except by use of a key. An operated station shall automatically condition itself so as to be visually detected as activated. Manual stations shall be constructed of red-colored polycarbonate material with clearly visible operating instructions provided on the cover. The word FIRE shall appear on the front of the stations in white letters, 1.00 inches (2.54 cm) or larger. Stations shall be suitable for surface mounting on matching backbox SB-10 or SB-I/O; or semi-flush mounting on a standard single-gang, double-gang, or 4" (10.16 cm) square electrical box, and shall be installed

within the limits defined by the Americans with Disabilities Act (ADA) or per national/local requirements. Manual Stations shall be Underwriters Laboratories listed.

Manual stations shall connect with two wires to one of the control panel SLC loops. The manual station shall, on command from the control panel, send data to the panel representing the state of the manual switch. Manual stations shall provide address setting by use of rotary decimal switches.

Product Line Information

NOT-BG12LX: Dual-action addressable pull station. Includes key locking feature. (Listed for Canadian and non-Canadian applications.)

SB-10: Surface backbox; metal.

SB-I/O: Surface backbox; plastic.

BG12TR: Optional trim ring.

17021: Keys, set of two.

Agency Listings and Approvals

In some cases, certain modules or applications may not be listed by certain approval agencies, or listing may be in process. Consult factory for latest listing status.

- **UL/ULC Listed:** S692 (listed for Canadian and non-Canadian applications).
- **MEA:** 67-02-E Vol. IV.
- **CSFM:** 7150-0028:0199.
- **FM Approved.**

Patented: U.S. Patent No. D428,351; 6,380,846; 6,314,772; 6,632,108.

NOTIFIER® is a registered trademark of Honeywell International Inc.
©2012 by Honeywell International Inc. All rights reserved. Unauthorized use of this document is strictly prohibited.



This document is not intended to be used for installation purposes.
We try to keep our product information up-to-date and accurate.
We cannot cover all specific applications or anticipate all requirements.
All specifications are subject to change without notice.



Made in the U. S. A.

For more information, contact Notifier. Phone: (203) 484-7161, FAX: (203) 484-7118.
www.notifier.com

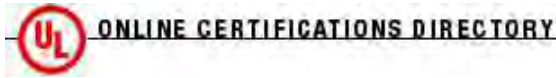

UNI7.S692 Boxes, Noncoded Certified for Canada

[Page Bottom](#)

Boxes, Noncoded Certified for Canada

[See General Information for Boxes, Noncoded Certified for Canada](#)

NOTIFIER

S692

12 CLINTONVILLE RD
NORTHFORD, CT 06472 USA

Models NBG-12, -12L, -12LA, -12LPS, -12LPSP, -12LR, -12LRA, -12LSP, -12LW, -12LWP, -12LX, -12LXBL, -12LXP, -12LXSP, -12NC, -12PS, -12S, -12SP, -12W, -12WP, NOT-BG12LX; Models NBG-12LAO, -12LAOB, -12LO, -12LOB, -12LW, -12LWP, -12W, -12WP are for outdoor use when used with a back box as specified in the installation instructions.

Back boxes, Models SB-I/O, 58BB.

[Last Updated](#) on 2007-12-05

[Questions?](#)

[Print this page](#)

[Terms of Use](#)

[Page Top](#)

© 2012 UL LLC

When the UL Leaf Mark is on the product, or when the word "Environment" is included in the UL Mark, please search the [UL Environment database](#) for additional information regarding this product's certification.

The appearance of a company's name or product in this database does not in itself assure that products so identified have been manufactured under UL's Follow-Up Service. Only those products bearing the UL Mark should be considered to be Listed and covered under UL's Follow-Up Service. Always look for the Mark on the product.

UL permits the reproduction of the material contained in the Online Certification Directory subject to the following conditions: 1. The Guide Information, Designs and/or Listings (files) must be presented in their entirety and in a non-misleading manner, without any manipulation of the data (or drawings). 2. The statement "Reprinted from the Online Certifications Directory with permission from UL" must appear adjacent to the extracted material. In addition, the reprinted material must include a copyright notice in the following format: "© 2012 UL LLC".

NP-200 Series

Addressable Photoelectric Detectors



Addressable Devices

General

The NOTIFIER NP-200 Series intelligent plug-in smoke detectors are designed for both performance and aesthetics. A new modern, sleek, contemporary design and enhanced optical sensing chamber is engineered to sense smoke produced by a wide range of combustion sources in accordance with more stringent code standards. Exclusively for use with NOTIFIER's FireWarden Series Addressable Fire Alarm Control Panels, the NP-200 Series point ID capability allows each detector's address to be set with rotary, decimal address switches, providing exact detector location for emergency personnel quickly locate a fire during its early stages, potentially saving precious rescue time while also reducing property damage. Two LEDs on each sensor light to provide a local, visible sensor indication. Dual electronic thermistors add 135°F (57°C) fixed temperature thermal sensing on the NP-200T. The NP-200R is a remote test capable detector for use with DNR Series duct detector housings.

Features

SLC LOOP

- Two-wire loop connection.
- Unit uses base for wiring.

ADDRESSING

- Addressable by device.
- Rotary, decimal addressing: *Please refer to the FireWarden panel manuals for device capacity.*

ARCHITECTURE

- New modern profile for improved aesthetics.
- Unique single-source design to respond quickly and dependably to a broad range of fires.
- Integral communications and built-in type identification.
- Built-in tamper-resistant feature.
- Removable cover and insect-resistant screen for simple field cleaning.

OPERATION

- Designed to meet UL 268 7th Edition.
- Factory preset at 1.5% nominal sensitivity for panel alarm threshold level.
- Visible LED "blinks" when the unit is addressed (communicating with the fire panel) and latches on in alarm.
- Low standby current.

MECHANICALS

- Sealed against back pressure.
- Mounts to: single-gang box, 3.5" (8.89 cm) or 4.0" (10.16 cm) octagonal box, or 4.0" (10.16 cm) square electrical box (*with or without a mud ring - not included*).

OPTIONS

- Remote LED output connection, RA100Z.

Installation

NP-200 series plug-in detectors use a detachable mounting base to simplify installation, service and maintenance.



NP-200 in B300-6 Base

Mount base (all base types) on an electrical backbox which is at least 1.5" (3.81 cm) deep. For a chart of compatible junction boxes, see *DN-60054*.

NOTE: *Because of the inherent supervision provided by the SLC loop, end-of-line resistors are not required. Wiring "T-taps" or branches are permitted for Style 4 (Class B) wiring. NP-200R mounts in a DNR/DNRW duct detector housing.*

Operation

Each NP-200 Series detector uses one possible addresses on the FireWarden Signaling Line Circuit (SLC). It responds to regular polls from the system and reports its type and status.

Detector Sensitivity Test

Each detector can have its sensitivity tested (required per NFPA 72, Chapter 14 on *Inspection, Testing and Maintenance*) when installed/connected to an FireWarden Series addressable fire alarm control panel. The results of the sensitivity test can be printed off the FireWarden Series for record keeping.

Specification

Voltage range: 15 – 32 VDC (peak).

Standby current: 200 μ A @ 24 VDC.

Max current: 4.5 mA @ 24 VDC (latched "ON").

Air velocity: 4,000 ft./min. (20 m/sec.) maximum.

Sensitivity: UL Applications: 0.5% to 4.0% per foot obscuration

Size: 2.0" (5.3 cm) high; base determines diameter.

– B300-6: 6.1" (15.6 cm) diameter.

– B501: 4" (10.2 cm) diameter.

For a complete list of detector bases see *DN-60981*.

Shipping weight: 3.4 oz. (95 g).

Operating temperature range:

- NP-200: 0°C to 50°C (32°F to 122°F);
- NP-200T: 0°C to 38°C (32°F to 100°F).
- NP-200R: installed in a DNR(A)/DNRW -20°C to 70°C (-4°F to 158°F).



IMPROVED CERTIFICATIONS SEARCH TOOL. REGISTER NOW!

[LEARN MORE](#)

UROX.S1115 Smoke Detectors for Fire Alarm Systems

[Page Bottom](#)

Smoke Detectors for Fire Alarm Systems

[See General Information for Smoke Detectors for Fire Alarm Systems](#)**NOTIFIER**

12 Clintonville Rd
Northford, CT 06472-1610 USA

S1115

Detector	Application	Type	Compatibility Restrictions	Velocity Range (fpm)		Date of Manufacture	Time of Manufacture Firmware Version	Firmware Version Update
				Min	Max			
CP-651	OAP, RS	I	D2	0	1200	-	-	-
CPX551B	OAP	I	D1	0	1500	-	-	-
DSA-04L, DSA-24L	D(I)	P	None	0	300	-	-	-
FAPT-851C	OAP, D(I)	P(IHD)	D2	0	4000	-	-	-
FCO-851 (CO)	OAP	P(IHD)	D4	0	4000	-	-	-
FSB-200, FSB-200S, JTY-H-FSB-200S	OAP	PB	D2			-	-	-
FSC-851	OAP	P(IHD)	D4	0	4000	-	-	-
FSH-751	OAP, D(I)	P	D1	0	4000	-	-	-
FSI-851	OAP	I	D2	0	1200	-	-	-
FSL-751 (b), FSL-751E (b)	OAP	Laser	None			-	-	-
FSP-851, FSP-851-BR, JTY-GD-FSP-851C, JTY-GD-FSP-851, FSP-851R								
	OAP, D(I)	P	D2	0	4000	-	-	-
FSP-851T, FAPT-851	OAP, D(I)	P(IHD)	D2	0	4000	-	-	-
FSP-951 (g)(i), FSP-951R (g)(i), NP-200 (g)(i), NP-200R (g)(i)								
	OAP, D(I)	P	D2	0	4000	-	-	-
FSP-951T (g)(h), FSP-951T-ISO (g)(h), NP-200T (g)(h)								
	OAP, D(I)	P	D2	0	4000	-	-	-
FSV-951 (I)(m), FSV-951-IV (I)(m), FSV-951C (I)(m), FSV-951R (I)(m), FSV-951R-IV (I)(m), FSV-951RC (I)(m)								
	OAP, D(I)	P	D2	0	4000	-	-	-
FWD-200ACCLIMATE	OAP	P(RF)	D2	0	4000	-	-	-
FWD-200P	OAP	P(RF)	D2	0	4000	-	-	-
FWD-200PT	OAP	P(RF)	D2	0	4000	-	-	-

		(IHD)						
HPX751	OAP	P	D1	0	300	-	-	-
JTF-YW-FSP-851TC	OAP, D(I)	P(IHD)	D2	0	4000	-	-	-
JTY-GD-FSP-951G	OAP	P	D2	0	300	-	-	-
LPX751L	OAP, D(I)	P	D2	0	4000	-	-	-
N124C, N125C	OAP, D(I)	P	D1	400	4000	-	-	-
NDH, NDH-10	D(ST)	P	None	500	4500	-	-	-
NH-241	OAP	I	D1	0	1500	-	-	-
NI-100	OAP	I	D2	0	300	-	-	-
NP-100, NP-100R	OAP, D(I)	P	D2	0	4000	-	-	-
NP-A100	OAP	P(IHD)	D2	0	4000	-	-	-
NSD, NCP, NSDH, NCPH	OAP, RS	P	None	0	300	-	-	-
NSD-1, NSDH-1	OAP	P	None	0	300	-	-	-
NSD-2W, NSDH-2W	OAP, RS	P	D1	0	300	-	-	-
SD-651	OAP, D(I)	P	D2	0	3000	-	-	-
SDRF-751, SDRF-751S	OAP	P(RF)	D2	0	300	-	-	-
SDX-551B	OAP, D(I)	P	D2	0	3000	-	-	-
SDX-751 (b)	OAP, D(I)	P	None	300	4000	-	-	-
SIF-24	OAP	I	D1	0	300	-	-	-

Detector	Application	Type	Compatibility	Velocity Range (fpm)		Pressure Differential Between Sampling Tube		Date of Manufacture	Time of Manufacture	Firmware Version
				Min	Max	Min	Max			
FSL-751D (w. FSL-751 head)	D(ST)	I	D2	500	4000	0.05	1	-	-	-
FSD-751P, FSD-751RP	D(ST)	P	D2	500	4000	0.03	1.4	-	-	-
FSD-751PL	D(ST)	P	D2	100	4000	0.03	1.4	-	-	-
FSD-751RPL (a)	D(ST)	P	D2	100	4000	0.03	1.4	-	-	-
NP-100T	OAP, D(ST), D(I)	P	D2	100	4000	0.03	1.4	-	-	-
DHX-502 (b) w. 1551 head	D(ST)	I	D2	500	4000	0.01	1.2	-	-	-
DHX-502 (b) w. 2551 head	D(ST)	P	D2	500	4000	0.01	1.2	-	-	-
DHX-502 (b) w. 7251 head	D(ST)	Laser	D2			0.01	1.2	-	-	-
FSL-751DNR	D(ST)	P	D2	300	4000	0.01	1.11	-	-	-
ND-200 (c)(d)	D(ST)	P	D2	100	4000	0.01	1.11	-	-	-

Base Model	Related Detector	Control Unit Compatibility Restrictions
B-501, B501BH, B710LP	CPX-751, FS1-851, SDX-751, LPX-751L	B2
B200S (j), B200S-LF (j), B200SR (j), B200SR-LF (j), B210LP, B224BI (j), B224RB (j), B300-6 (j), B300-6-IS (j), B501 (j)(k), B710LP		
	FSP-951, FSP-951R, FSP-951T, FSP-951T-ISO, NP-200, NP-200R, NP-200T, FSV-951, FSV-951-IV, FSV-951C, FSV-951R, FSV-951R-IV, FSV-951RC	B4
B210LP, B210LP-BR	1251, 2251, 3251, 7251, FCO-851	B2
B401, B110LP, B110RLP, B112LP, B114LP(RS), (BT), B116LP(RS), B401BH, B401B, B401LP, B401R, B402B, B404B, B404BT, B406B, B710LP		
	1151, 1151EIS, 2151	B2
B401, B401B, B401BH, B401BR, B401R	1451, 2451, 2451TH, JTY-GD-2451	B2
B501(k), B200S(j), B210LP, B224RB(j), B224BI(j)		
	FSC-851, FCO-851	B4
B501B-FTX	FTX-P1 Filtrex	B2
B501BH-2, B501BHT-2, B406B(RS), B501(k), B501B		
	1451, 2451, 2451TH, 1551, 2551	B2
B501BH-3 (e) (f)	FSC-851, FSI-851, FSP-851, FSP-851T, FST-851, FST-851R, FST-851H, FAPT-851, FSL-751, SDX-751CH, FDX-551CH, HFS-P	B4
B610LP, B612LP (RS), B614LP (RS), B616LP (RS), B710HD		
	2151, 2151T, 1151, 5451, 1151EIS, 1451, CP-651, SD-651	B2
B710HD	FSH-751, H2351ADT, HPX-751	B1
B901G	-	None

B1 - Listing limited to specific system control unit. Information on compatible control unit indicated on installation drawing of control unit and/or detector.

B2 - For connection to Listed control units with which compatibility was determined by test or a review of circuit parameters. Interconnection and compatible models indicated on installation wiring diagram for detector (base) and/or control unit.

B4 - For connection to any manufacturer's Listed compatible control unit.

D1 - Listing limited to specific system control unit. Information on compatible control unit indicated on installation drawing of control unit and/or detector.

D2 - For connection to Listed control units with which compatibility was determined by test or a review of circuit parameters. Interconnection and compatible models indicated on installation wiring diagram for detector (base) and/or control unit.

D4 - For connection to any manufacturer's Listed compatible control unit.

OAP - Open Area Protection

RS - Releasing Service

I - Ionization

D(I) - Duct Detector - Installation Inside Duct

P - Photoelectric

IHD - Includes Integral Heat Detector

PB - Projected Beam

RF - Includes Integral Radio Frequency Transmitter

D(ST) - Duct Detector - Sampling Tubes

Date of Manufacture identifies the manufacturing start date of all product models that will use the specific Time of Manufacture Firmware Version. The date of manufacture is noncoded and in the format YEAR (in 4 digits), MONTH (in letters), DAY (in 2 digits).

Time of Manufacture Firmware Version identifies a numerical and/or alphabetic series designation that is product and date-code specific and will only identify the Firmware Version at the time the product was manufactured. The numeric and/or alphabetic sequence is defined by the manufacturer.

Firmware Version Update is a numerical and/or alphabetic sequential identification that is product and date-code specific and sequentially identifies the Firmware Version Update from the previous version of firmware. The numerical and/or alphabetic sequence is defined by the manufacturer.

- (a) - Suitable for use in ambient temperatures of 0-55 C (23-131 F).
 - (b) - Special application.
 - (c) - Suitable for elevated temperatures up to 70 C
 - (d) - ND-200 duct housing can be used with the following compatible detector heads: NP-100, NP-100R
 - (e) - Complimentary listed to UL 464 (ULSZ).
 - (f) - Suitable for use in ambient temperatures of -20 to 49 C (-4 to 120 F)
 - (g) - Model number may be followed by a two digit suffix, indicating the color of the detector's enclosure: no suffix for white, -IV for ivory, -BL for black, etc.
 - (h) - Complimentary listed to UL 521 (UQGS).
 - (i) - Suitable for use in ambient temperatures of 0-50 C (32-122 F).
 - (j) - Model number may be followed by a two digit suffix, indicating the color of the enclosure: -WH for white, -IV for ivory, -BL for black, etc.
 - (k) - Model number may be followed by a suffix, indicating the color of the enclosure: -WHITE for white, -IV for ivory, -BL for black, etc.
 - (l) - Suitable for use in Special Application installations with system sensitivity setting between 0.02 and 0.5 percent per foot obscuration.
 - (m) - Suitable for use in ambient temperatures of -10-60 C (14-140 F).
- CO - Suitable for use as a carbon monoxide alarm

Last Updated on 2018-08-19

[Questions?](#)

[Print this page](#)

[Terms of Use](#)

[Page Top](#)

© 2018 UL LLC

The appearance of a company's name or product in this database does not in itself assure that products so identified have been manufactured under UL's Follow-Up Service. Only those products bearing the UL Mark should be considered to be Certified and covered under UL's Follow-Up Service. Always look for the Mark on the product.

UL permits the reproduction of the material contained in the Online Certification Directory subject to the following conditions: 1. The Guide Information, Assemblies, Constructions, Designs, Systems, and/or Certifications (files) must be presented in their entirety and in a non-misleading manner, without any manipulation of the data (or drawings). 2. The statement "Reprinted from the Online Certifications Directory with permission from UL" must appear adjacent to the extracted material. In addition, the reprinted material must include a copyright notice in the following format: "© 2018 UL LLC".

Relative humidity: 10%-93%, non-condensing.

Listings

Listings and approvals below apply to the NP200 Series detectors. In some cases, certain detectors may not be listed by certain approval agencies, or listing may be in process. Consult factory for latest listing status.

- UL/ULC Listed: S911
- CSFM: 7272-0028:0503
- FM Approved

Product Line Information

NOTE: Detectors must be mounted to one of the Intelligent Bases listed below.

NOTE: "IV" suffix indicates FlashScan® and CLIP device.

NP-200: White, Addressable photoelectric detector; B300-6 base included. FlashScan only.

NP-200-IV: Ivory, Addressable photoelectric detector; B300-6 base included.

NP-200T: White, Same as NP-200 but with thermal element; B300-6 base included. FlashScan only.

NP-200T-IV: Ivory, Same as NP-200 but with thermal element; B300-6 base included.

NP-200R: White, Remote test capable addressable photoelectric detector for use with DNR(A)/DNRW. FlashScan only.

NP-200R-IV: Ivory, Remote test capable addressable photoelectric detector; for use with DNR(A)/DNRW.

INTELLIGENT BASES

NOTE: For details on intelligent bases, see DN-60981.

B300-6: White, 6" base, standard flanged low-profile mounting base. (CSFM: 7300-1653:0109 Pending)

B300-6-IS: White, 6" base isolator. (CSFM: 7300-1653:0109 Pending)

B300-6-IV: Ivory, 6" base, standard flanged low-profile mounting base. (CSFM: 7300-1653:0109 Pending)

B300A-6: Same as B300-6, ULC listed.

B300A-6-IV: Ivory, 6" standard flanged low-profile mounting base, ULC listed.

B300-6-BP: Bulk pack of B300-6, package contains 10

B501-WHITE: White, 4" standard European flangeless mounting base. UL/ULC listed. (CSFM: 7300-1653:0109 Pending)

B501-BL: Black, 4" standard European flangeless mounting base. UL/ULC listed. (CSFM: 7300-1653:0109 Pending)

B501-IV: Ivory color, 4" standard European flangeless mounting base. UL/ULC listed. (CSFM: 7300-1653:0109 Pending)

B501BP: Bulk pack of B501-WHITE contains 10.

B224RB-WH: White, relay base. (CSFM: 7300-1653:0216 Pending)

B224RB-IV: Ivory, relay base. (CSFM: 7300-1653:0216 Pending)

B224RBA-WH: White, relay base, ULC listing.

B224RBA-IV: Ivory, relay base, ULC listing.

B224BI-WH: White, **isolator** detector base. (CSFM: 7300-1653:0216 Pending)

B224BI-IV: Ivory **isolator** detector base. (CSFM: 7300-1653:0216 Pending)

B224BIA-WH: White, **isolator** detector base, ULC listing.

B224BIA-IV: Ivory **isolator** detector base, ULC listing.

B200S-WH: White, Intelligent addressable sounder base capable of producing sound output in high or low volume with ANSI Temporal 3, ANSI Temporal 4, continuous tone, marching tone, and custom tone. Uses FlashScan protocol. (CSFM: 7300-1653:0213 Pending)

B200S-IV: Ivory, Intelligent addressable sounder base capable of producing sound output in high or low volume with ANSI Temporal 3, ANSI Temporal 4, continuous tone, marching tone, and custom tone. Uses FlashScan protocol. (CSFM: 7300-1653:0213 Pending)

B200SA-WH: Same as B200S-WH, ULC listing.

B200SA-IV: Same as B200S-IV, ULC listing.

B200SCOA-WH: White, Intelligent, programmable sounder base in English/French (required in Canada for ULC applications with SO Series detector applications).

B200SCOA-IV: Ivory Intelligent, programmable sounder base in English/French (required in Canada for ULC applications with SO Series detector applications, ULC listing).

B200S-LF-WH: White, Low Frequency Intelligent, programmable sounder base. Produces a fundamental frequency of 520 Hz +/- 10% with a square wave or its equivalent; designed to meet the NFPA 72 sleeping space requirement. (CSFM: 7300-1653:0238 Pending)

B200S-LF-IV: Ivory, Low Frequency Intelligent, programmable sounder base. Produces a fundamental frequency of 520 Hz +/- 10% with a square wave or its equivalent; designed to meet the NFPA 72 sleeping space requirement. (CSFM: 7300-1653:0238 Pending)

B200SR-WH: White, Intelligent sounder base capable of producing sound output with ANSI Temporal 3 or continuous tone. Intended for retrofit applications. (CSFM: 7300-1653:0213 Pending)

B200SR-IV: Ivory, Intelligent sounder base capable of producing sound output with ANSI Temporal 3 or continuous tone. Intended for retrofit applications. (CSFM: 7300-1653:0213 Pending)

B200SRA-WH: Same as B200SR-WH with, ULC listing.

B200SRA-IV: Same as B200SR-IV in Ivory color, ULC listing.

B200SR-LF-WH: White, Low Frequency Intelligent, programmable sounder base. Produces a fundamental frequency of 520 Hz +/- 10% with a square wave or its equivalent; designed to meet the NFPA 72 sleeping space requirement. Intended for retrofit applications. (CSFM: 7300-1653:0238 Pending)

B200SR-LF-IV: Ivory, Low Frequency Intelligent, programmable sounder base. Produces a fundamental frequency of 520 Hz +/- 10% with a square wave or its equivalent; designed to meet the NFPA 72 sleeping space requirement. Intended for retrofit applications. (CSFM: 7300-1653:0238 Pending)

MOUNTING KITS AND ACCESSORIES

TR300: White, replacement flange for B210LP(A) base.

TR300-IV: Ivory, replacement flange for B210LP(A) base.

RA100Z(A): Remote LED annunciator. 3 – 32 VDC. Mounts to a U.S. single-gang electrical box. For use with B501(A) and B300-6(A).

M02-04-00: Test magnet.

M02-09-00: Test magnet with telescoping handle.

NOTIFIER® and **FIREWARDEN®** are a registered trademark of Honeywell International Inc.

©2018 by Honeywell International Inc. All rights reserved. Unauthorized use of this document is strictly prohibited.



This document is not intended to be used for installation purposes.
We try to keep our product information up-to-date and accurate.
We cannot cover all specific applications or anticipate all requirements.
All specifications are subject to change without notice.

For more information, contact Notifier. Phone: (800) 627-3473, FAX: (203) 484-7118.
www.notifier.com

NH-200 Series

Intelligent Addressable Thermal Detectors for FireWarden Series



Addressable Devices

General

The NOTIFIER NH-200 Series intelligent thermal detectors are designed for both performance and aesthetics. A new modern, sleek, contemporary design and advanced thermal technologies make the NH-200 Series ideal for both system operation and building design. The point ID address, set using rotary decimal switches, provide specific detector locations.

Compatible with FireWarden Series fire alarm control panels. The series includes a 135°F/57°C fixed-temperature, rate-of-rise and a 190°F/88°C fixed high-temperature detectors. These thermal detectors provide effective, intelligent property protection in a variety of applications.

Features

SLC LOOP:

- Two-wire SLC loop connection.
- Unit uses base for wiring.

ADDRESSING:

- Addressable by device.
- Rotary, decimal addressing. *Please refer to the FireWarden panel manuals for device capacity.*

ARCHITECTURE:

- Sleek, low-profile, stylish design.
- State-of-the-art thermistor technology for fast response.
- Integral communications and built-in device-type identification.
- Built-in tamper resistant feature.
- Built-in functional test switch activated by external magnet.

OPERATION:

- Fixed temperature model (NH-200) factory preset to 135°F (57°C).
- Rate-of-rise model (NH-200R), 15°F (8.3°C) per minute.
- High-temperature model (NH-200H) factory preset to 190°F (88°C).
- 360°-field viewing angle of the visual alarm indicators (two bicolor LEDs). LEDs blink red in Normal condition and turn on steady red in Alarm.
- Visible LEDs "blink" every time the unit is addressed.

MECHANICALS:

- Sealed against back pressure.
- SEMS screws for wiring of the separate base.
- Designed for direct-surface or electrical-box mounting.
- Plugs into separate base for ease of installation and maintenance.
- Separate base allows interchange of photoelectric, ionization and thermal sensors.

OTHER SYSTEM FEATURES:

- Remote test feature from the panel.
- Walk test with address display.
- Low standby current. 94-5V plastic flammability rating.

Options:

- Remote LED output connection to optional RA100Z remote LED annunciator.



NH-200R in B300-6 Base

- Flanged surface mounting kit.

Installation

NH-200 Series plug-in intelligent thermal detectors use a detachable base to simplify installation, service and maintenance. Installation instructions are shipped with each detector.

Mount base (all base types) on an electrical backbox which is at least 1.5" (3.81 cm) deep. For a chart of compatible junction boxes, see *DN-60054*.

NOTE: Because of the inherent supervision provided by the SLC loop, end-of-line resistors are not required. Wiring "T-taps" or branches are permitted for Style 4 (Class "B") wiring only.

Applications

Use thermal detectors for protection of property.

Construction

These detectors are constructed of fire-resistant plastic. The NH-200 Series plug-in intelligent thermal detectors are designed to commercial standards and offer an attractive appearance.

Operation

Each NH-200 Series detector uses one of 159 (panel dependent) possible addresses on the FireWarden Signaling Line Circuit (SLC). It responds to regular polls from the control panel and reports its type and the status. If it receives a test command from the panel (or a local magnet test), it stimulates its electronics and reports an alarm. It blinks its LEDs when polled and turns the LEDs on when commanded by the panel. The NH-200 Series offers features and performance that represent the latest in thermal detector technology.

Specifications

Sensitivity: UL Applications: 0.5% to 4.0% per foot obscuration. ULC is 0.5% to 3.5%.

Size: 2.0" (5.3 cm) high; base determines diameter.

- **B300-6:** 6.1" (15.6 cm) diameter.

– **B501:** 4" (10.2 cm) diameter.

For a complete list of detector bases see DN-60981

Shipping weight: 3.4 oz. (95 g).

Operating temperature range: H365, H365R Series: –20°C to 38°C (–4°F to 100°F); H365H: –20°C to 66°C (–4°F to 150°F).

Detector spacing: UL approved for 50 ft. (15.24 m) center to center. FM approved for 25 x 25 ft. (7.62 x 7.62 m) spacing.

Relative humidity: 10% – 93% noncondensing.

Thermal ratings: fixed-temperature set point 57°C (135°F), rate-of-rise detection 8.3°C (15°F) per minute, high temperature heat 88°C (190°F).

Mounting: B300-6(A) flanged base, included.

See “**Product Line Information: Intelligent Bases,**” if using a different base.

Fixed-temperature setpoint: 135°F (57°C) for the NH-200 and NH-200R; 190°F (88°C) for the NH-200H.

Rate-of-rise detection: responds to greater than 15°F (8.3°C) per minute.

ELECTRICAL SPECIFICATIONS

Voltage range: 15 - 32 volts DC peak.

Standby current (max. avg.): 200uA @ 24 VDC (one communication every 5 seconds with LED enabled).

Max current: 4.5 mA @ 24 VDC (“ON”).

Listings and Approvals

Listings and approvals below apply to the NH-200(A) Series detectors. In some cases, certain modules may not be listed by certain approval agencies, or listing may be in process. Consult factory for latest listing status.

- UL/ULC Listing: S2101
- FM Approved
- CSFM: 7270-0028:0502

Product Line Information

NOTE: “-IV” suffix indicates CLIP and FlashScan device.

NH-200: White, low-profile intelligent 135°F fixed thermal sensor, B300-6 base included.

NH-200-IV: Ivory, low-profile intelligent 135°F fixed thermal sensor, B300-6 base included.

NH-200R: White, low-profile intelligent rate-of-rise thermal sensor, B300-6 base included.

NH-200R-IV: Ivory, low-profile intelligent rate-of-rise fixed thermal sensor, B300-6 base included.

NH-200H: White, low-profile intelligent 190°F fixed thermal sensor, B300-6 base included.

NH-200HT-IV: Ivory, low-profile intelligent 190°F thermal sensor, B300-6 base included.

INTELLIGENT BASES

NOTE: For details on intelligent bases, see DN-60981.

B300-6: White, 6" base, standard flanged low-profile mounting base. (CSFM: 7300-1653:0109)

B300-6-IV: Ivory, 6" base, standard flanged low-profile mounting base. (CSFM: 7300-1653:0109)

B300A-6: Same as B300-6, ULC listed.

B300A-6-IV: Ivory, 6" standard flanged low-profile mounting base, ULC listed.

B300-6-BP: Bulk pack of B300-6, package contains 10

B501-WHITE: White, 4" standard European flangeless mounting base. UL/ULC listed. (CSFM: 7300-1653:0109)

B501-BL: Black, 4" standard European flangeless mounting base. UL/ULC listed. (CSFM: 7300-1653:0109)

B501-IV: Ivory color, 4" standard European flangeless mounting base. UL/ULC listed. (CSFM: 7300-1653:0109)

B501-WHITE-BP: Bulk pack of B501-WHITE contains 10.

B224RB-WH: White, relay base. (CSFM: 7300-1653:0216)

B224RB-IV: Ivory, relay base. (CSFM: 7300-1653:0216)

B224RBA-WH: White, relay base, ULC listing.

B224RBA-IV: Ivory, relay base, ULC listing.

B224BI-WH: White, *isolator* detector base. (CSFM: 7300-1653:0216)

B224BI-IV: Ivory *isolator* detector base. (CSFM: 7300-1653:0216)

B224BIA-WH: White, *isolator* detector base, ULC listing.

B224BIA-IV: Ivory *isolator* detector base, ULC listing.

B200S-WH: White, Intelligent addressable sounder base capable of producing sound output in high or low volume with ANSI Temporal 3, ANSI Temporal 4, continuous tone, marching tone, and custom tone. Uses FlashScan protocol. (CSFM: 7300-1653:0213)

B200S-IV: Ivory, Intelligent addressable sounder base capable of producing sound output in high or low volume with ANSI Temporal 3, ANSI Temporal 4, continuous tone, marching tone, and custom tone. Uses FlashScan protocol. (CSFM: 7300-1653:0213)

B200SA-WH: Same as B200S-WH, ULC listing.

B200SA-IV: Same as B200S-IV, ULC listing.

B200SCOA-WH: White, Intelligent, programmable sounder base in English/French (required in Canada for ULC applications with CO Series detector applications).

B200SCOA-IV: Ivory Intelligent, programmable sounder base in English/French (required in Canada for ULC applications with CO Series detector applications, ULC listing).

B200S-LF-WH: White, Low Frequency Intelligent, programmable sounder base. Produces a fundamental frequency of 520 Hz +/- 10% with a square wave or its equivalent; designed to meet the NFPA 72 sleeping space requirement. (CSFM: 7300-1653:0238)

B200S-LF-IV: Ivory, Low Frequency Intelligent, programmable sounder base. Produces a fundamental frequency of 520 Hz +/- 10% with a square wave or its equivalent; designed to meet the NFPA 72 sleeping space requirement. (CSFM: 7300-1653:0238)

B200SR-WH: White, Intelligent sounder base capable of producing sound output with ANSI Temporal 3 or continuous tone. Intended for retrofit applications. (CSFM: 7300-1653:0213)

B200SR-IV: Ivory, Intelligent sounder base capable of producing sound output with ANSI Temporal 3 or continuous tone. Intended for retrofit applications. (CSFM: 7300-1653:0213)

B200SRA-WH: Same as B200SR-WH with, ULC listing.

B200SRA-IV: Same as B200SR-IV in Ivory color, ULC listing.

B200SR-LF-WH: White, Low Frequency Intelligent, programmable sounder base. Produces a fundamental frequency of 520 Hz +/- 10% with a square wave or its equivalent; designed to meet the NFPA 72 sleeping space requirement. Intended for retrofit applications. (CSFM: 7300-1653:0238)

B200SR-LF-IV: Ivory, Low Frequency Intelligent, programmable sounder base. Produces a fundamental frequency of 520 Hz +/- 10% with a square wave or its equivalent; designed to meet the NFPA 72 sleeping space requirement. Intended for retrofit applications. (CSFM: 7300-1653:0238)

MOUNTING KITS AND ACCESSORIES

TR300: White, replacement flange for B210LP(A) base.

TR300-IV: Ivory, replacement flange for B210LP(A) base.

RA100Z(A): Remote LED annunciator. 3 – 32 VDC. Mounts to a U.S. single-gang electrical box. For use with B501(A) and B300-6(A).

M02-04-00: Test magnet.

M02-09-00: Test magnet with telescoping handle.

CK300: Color Kit (includes cover and trim ring), white, 10-pack.

CK300-IV: Color Kit (includes cover and trim ring), ivory, 10-pack.

CK300-BL: Color Kit (includes cover and trim ring), black, 10-pack.

FireWarden®, Notifier® and FlashScan® are registered trademarks of Honeywell International Inc.

NOTIFIER® and FireWarden® are registered trademarks of Honeywell International Inc.

©2018 by Honeywell International Inc. All rights reserved. Unauthorized use of this



This document is not intended to be used for installation purposes.
We try to keep our product information up-to-date and accurate.
We cannot cover all specific applications or anticipate all requirements.
All specifications are subject to change without notice.

For more information, contact Notifier. Phone: (800) 627-3473, FAX: (203) 484-7118.
www.notifier.com

UL PRODUCT CATEGORY

Heat-automatic Fire Detectors

See General Information for Heat-automatic Fire Detectors

NOTIFIER

S747

12 Clintonville Rd

Northford, CT 06472-1610 USA

Model No.	Type	Compatibility Restrictions	Contact Arrangement	Temp Range (°F)	Spacing (Ft)	
					Smooth Ceiling	to Wall or Partition
302 (vertically mounted)						
	FT/ROR	None	NO	135	50	25
				200	50	25
302H (horizontally mounted)						
	FT/ROR	None	NO	135	40	20
				200	40	20
DFE-135	FT	None	NO	135	50	25
DFE-190	FT	None	NO	190	50	25
FDX-551	FT	D1	-	135	50	25
FDX-551R	FT/ROR	None	-	135	50	25
FDX-751R, FST-851R, FST-851R-BR						
	FT/ROR	None	-	135	50	25
FST-751, FST-851	FT	D1	-	135	50	25
FST-851H	FT	D1	-	190	50	25
FST-951, FST-951-IV, NH-200, NH-200-IV						
	FT	D1	-	135	50	25
FST-951H, FST-951H-IV, NH-200H, NH-200H-IV						
	FT	D1	-	190	50	25
FST-951R, FST-951R-IV, NH-200R, NH-200R-IV						
	FT/ROR	D1	-	135	50	25

FWH-200FIX135	FT	D1	-	135	50	25
FWH-200ROR135	FT/ROR	D1	-	135	50	25
JTW-BD-FST-851C, JTW-BD-FST-851						
	FT	D2	-	-	-	-
JTW-BD-FST-951G	FT/ROR	D2	-	135	50	25
NH-100	FT/ROR	None	-	135	50	25
NH-100H (c)	FT	D2	-	190	50	25
NH-100R	FT	None	-	135	50	25
NP-A100 (a)	FT/ROR	D2	-	135	50	25

Base Model	Related Detector	Control Unit Compatibility Restrictions
	B200S, B200SA, B200S-LF, B200SR, B200SRA, B200SR-LF, B210LP, B210LPA, B224BI, B224BIA, B224RB, B224RBA, B300-6, B300-6-IS, B300A-6, B501, B710LP, B710LPA	
	FST-951, FST-951-IV, NH-200, NH-200-IV, FST-951H, FST-951H-IV, NH-200H, NH-200H-IV, NH-200H-BL, FST-951R, FST-951R-IV, FST-951R-BL, NH-200R, NH-200R-IV, FST-951A, FST-951A-IV, FST-951HA, FST-951HA-IV, FST-951RA, FST-951RA-IV,	B1

B1 - Listing limited to specific system control unit. Information on compatible control unit indicated on installation drawing of control unit and/or detector.

D1 - Listing limited to specific system control unit. Information on compatible control unit indicated on installation drawing of control unit and/or detector.

D2 - For connection to Listed control units with which compatibility was determined by test or a review of circuit parameters. Interconnection and compatible models indicated on installation wiring diagram for detector (base) and/or control unit.

FT/ROR - Fixed temperature/rate of rise combination

FT - Fixed temperature

(a) - Line wires join terminal screws in mounting base.

(c) - For connection to Listed Control Unit, Model ZXa manufactured by Morely and also for connection to Listed Control Unit, Shark Series 10-056 manufactured by Fike.

Note - Electrical ratings: Model FR: 6-120 v, ac, 1 amp; 6-24 v, dc, 0.5 amp. Models 302, 302H, 6-125 v, ac, 5 amp; 6-25 v, dc, 1.0 amp; 125 v, dc, 0.5 amp. Models 501, 502, 503, 504, 601, 602, 603, 604, 621, 622, 623, 624, 3 amp, 6-125 v, ac; 1 amp, 6-28 v, dc; 0.3 amp, 125 v, dc; 0.1 amp, 250 v, dc. Models A, AT, 6-125 v, ac, 6 amp; 6-28 v, dc, 3 amp; 125 v, dc, 1 amp; 250 v, dc, 0.3 amp.

The appearance of a company's name or product in this database does not in itself assure that products so identified have been manufactured under UL's Follow-Up Service. Only those products bearing the UL Mark should be considered to be Certified and covered under UL's Follow-Up Service. Always look for the Mark on the product.

UL permits the reproduction of the material contained in the Online Certification Directory subject to the following conditions: 1. The Guide Information, Assemblies, Constructions, Designs, Systems, and/or Certifications (files) must be presented in their entirety and in a non-misleading manner, without any manipulation of the data (or drawings). 2. The statement "Reprinted from the Online Certifications Directory with permission from UL" must appear adjacent to the extracted material. In addition, the reprinted material must include a copyright notice in the following format: "© 2019 UL LLC".

UL and the UL logo are trademarks of UL LLC © 2019 All Rights Reserved.

Monitor Modules

**NMM-100(A), NMM-100P(A),
NZM-100(A), and NDM-100(A)
for FireWarden Series Panels**



Intelligent Addressable Devices

General

Four different monitor modules are available for Notifier's FireWarden Series intelligent control panels for a variety of applications. Monitor modules supervise a circuit of dry-contact input devices, such as conventional heat detectors and pull stations, or monitor and power a circuit of two-wire smoke detectors (NZM-100(A)).

NMM-100(A) is a standard-sized module (typically mounts to a 4" [10.16 cm] square box) that supervises either a Style D (Class A) or Style B (Class B) circuit of dry-contact input devices.

NMM-100P(A) is a miniature monitor module a mere 1.3" (3.302 cm) H x 2.75" (6.985 cm) W x 0.5" (1.270 cm) D that supervises a Style B (Class B) circuit of dry-contact input devices. Its compact design allows the NMM-100P(A) to be mounted in a single-gang box behind the device it monitors.

NZM-100(A) is a standard-sized module that monitors and supervises compatible two-wire, 24 volt, smoke detectors on a Style D (Class A) or Style B (Class B) circuit.

NDM-100(A) is a standard-sized dual monitor module that monitors and supervises two independent two-wire Style B (Class B) dry-contact initiating device circuits (IDCs) at two separate, consecutive addresses in intelligent, two-wire systems.

NMM-100(A) Monitor Module

- Built-in type identification automatically identifies this device as a monitor module to the control panel.
- Powered directly by two-wire SLC loop. No additional power required.
- High noise (EMF/RFI) immunity.
- SEMS screws with clamping plates for ease of wiring.
- Direct Decade entry of address: 01 – 99 on FireWarden-100-2, 01 – 50 on FireWarden-50.
- LED flashes during normal operation and latches on steady to indicate alarm.

The NMM-100(A) Monitor Module is intended for use in intelligent, two-wire systems, where the individual address of each module is selected using the built-in rotary switches. It provides either a two-wire or four-wire fault-tolerant Initiating Device Circuit (IDC) for normally-open-contact fire alarm and supervisory devices. The module has a panel-controlled LED indicator.

NMM-100(A) APPLICATIONS

Use to monitor a zone of four-wire smoke detectors, manual fire alarm pull stations, waterflow devices, or other normally-open dry-contact alarm activation devices. May also be used to monitor normally-open supervisory devices with special supervisory indication at the control panel. Monitored circuit may be wired as an NFPA Style B (Class B) or Style D (Class A) Initiating Device Circuit. A 47K ohm End-of-Line Resistor (provided) terminates the Style B circuit. No resistor is required for supervision of the Style D circuit.



NMM-100(A) (Type H)

NMM-100(A) OPERATION

Each NMM-100(A) uses one of the available module addresses on an SLC loop. It responds to regular polls from the control panel and reports its type and the status (open/normal/short) of its Initiating Device Circuit (IDC). A flashing LED indicates that the module is in communication with the control panel. The LED latches steady on alarm (subject to current limitations on the loop).

NMM-100(A) SPECIFICATIONS

Nominal operating voltage: 15 to 32 VDC.

Maximum current draw: 5.0 mA (LED on).

Average operating current: 350 μ A (LED flashing), 1 communication every 5 seconds, 47k EOL.

Maximum IDC wiring resistance: 40 ohms.

EOL resistance: 47K ohms.

Temperature range: 32°F to 120°F (0°C to 49°C).

Humidity range: 10% to 93% noncondensing.

Dimensions: 4.5" (11.43 cm) high x 4" (10.16 cm) wide x 1.25" (3.175 cm) deep. Mounts to a 4" (10.16 cm) square x 2.125" (5.398 cm) deep box.

NMM-100P(A) Mini Monitor Module

- Built-in type identification automatically identifies this device as a monitor module to the panel.
- Powered directly by two-wire SLC loop. No additional power required.
- High noise (EMF/RFI) immunity.
- Tinned, stripped leads for ease of wiring.
- Direct Decade entry of address: 01 – 99 on FireWarden-100-2, 01 – 50 on FireWarden-50.

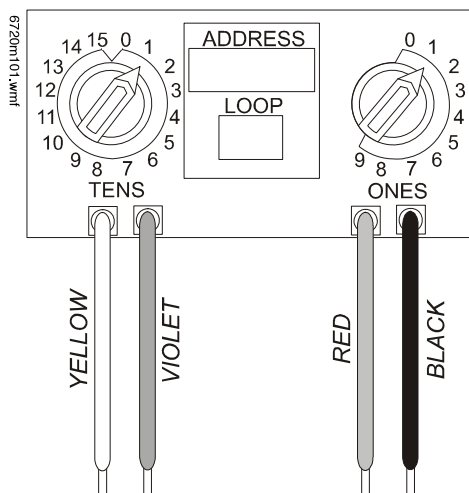

The NMM-100P(A) Mini Monitor Module can be installed in a single-gang junction directly behind the monitored unit. Its small size and light weight allow it to be installed without rigid mounting. The NMM-100P(A) is intended for use in intelligent, two-wire systems where the individual address of each module is selected using rotary switches. It provides a two-wire initiating device circuit for normally-open-contact fire alarm and security devices. NMM-100P(A)

NMM-100P(A) APPLICATIONS

Use to monitor a single device or a zone of four-wire smoke detectors, manual fire alarm pull stations, waterflow devices, or other normally-open dry-contact devices. May also be used to monitor normally-open supervisory devices with special supervisory indication at the control panel. Monitored circuit/device is wired as an NFPA Style B (Class B) Initiating Device Circuit. A 47K ohm End-of-Line Resistor (provided) terminates the circuit.

NMM-100P(A) OPERATION

Each NMM-100P(A) uses one of the available module addresses on an SLC loop. It responds to regular polls from the control panel and reports its type and the status (open/normal/short) of its Initiating Device Circuit (IDC).

NMM-100P(A) SPECIFICATIONS

Nominal operating voltage: 15 to 32 VDC.

Average operating current: 350 μ A, 1 communication every 5 seconds, 47k EOL; 600 μ A Max. (Communicating, IDC Shorted).

Maximum IDC wiring resistance: 40 ohms.

Maximum IDC Voltage: 11 Volts.

Maximum IDC Current: 400 μ A.

EOL resistance: 47K ohms.

Temperature range: 32°F to 120°F (0°C to 49°C).

Humidity range: 10% to 93% noncondensing.

Dimensions: 1.3" (3.302 cm) high x 2.75" (6.985 cm) wide x 0.65" (1.651 cm) deep.

Wire length: 6" (15.24 cm) minimum.

NZM-100(A) Interface Module

- Supports compatible two-wire smoke detectors.
- Supervises IDC wiring and connection of external power source.
- High noise (EMF/RFI) immunity.
- SEMS screws with clamping plates for ease of wiring.
- Direct Decade entry of address: 01 – 99 on FireWarden-100-2, 01 – 50 on FireWarden-50.
- LED flashes during normal operation.
- LED latches steady to indicate alarm on command from control panel.

The NZM-100(A) Interface Module is intended for use in intelligent, addressable systems, where the individual address of each module is selected using built-in rotary switches. This module allows intelligent panels to interface and monitor two-wire conventional smoke detectors. It transmits the status (normal, open, or alarm) of one full zone of conventional detectors back to the control panel. All two-wire detectors being monitored must be UL compatible with the module.

NZM-100(A) APPLICATIONS

Use the NZM-100(A) to monitor a zone of two-wire smoke detectors. The monitored circuit may be wired as an NFPA Style B (Class B) or Style D (Class A) Initiating Device Circuit. A 3.9 K ohm End-of-Line Resistor (provided) terminates the end of the Style B or D (class B or A) circuit (maximum IDC loop resistance is 25 ohms). Install ELR across terminals 8 and 9 for Style D application.

NZM-100(A) OPERATION

Each NZM-100(A) uses one of the available module addresses on an SLC loop. It responds to regular polls from the control panel and reports its type and the status (open/normal/short) of its Initiating Device Circuit (IDC). A flashing LED indicates that the module is in communication with the control panel. The LED latches steady on alarm (subject to current limitations on the loop).

NZM-100(A) SPECIFICATIONS

Nominal operating voltage: 15 to 32 VDC.

Maximum current draw: 5.1 mA (LED on).

Maximum IDC wiring resistance: 25 ohms.

Average operating current: 300 μ A, 1 communication and 1 LED flash every 5 seconds, 3.9k eol.

EOL resistance: 3.9K ohms.

External supply voltage (between Terminals T3 and T4): DC voltage: 24 volts power limited. Ripple voltage: 0.1 Vrms maximum. Current: 90 mA per module maximum.

Temperature range: 32°F to 120°F (0°C to 49°C).

Humidity range: 10% to 93% noncondensing.

Dimensions: 4.5" (11.43 cm) high x 4" (10.16 cm) wide x 1.25" (3.175 cm) deep. Mounts to a 4" (10.16 cm) square x 2.125" (5.398 cm) deep box.

NDM-100(A) Dual Monitor Module

The NDM-100(A) Dual Monitor Module is intended for use in intelligent, two-wire systems. It provides two independent two-wire initiating device circuits (IDCs) at two separate, consecutive addresses. It is capable of monitoring normally open contact fire alarm and supervisory devices. The module has a single panel-controlled LED.

NOTE: The NDM-100(A) provides two Style B (Class B) IDC circuits ONLY. Style D (Class A) IDC circuits are NOT supported in any application.

NDM-100(A) SPECIFICATIONS

Normal operating voltage range: 15 to 32 VDC.

Maximum current draw: 6.4 mA (LED on).

Average operating current: 750 μ A (LED flashing).

Maximum IDC wiring resistance: 1,500 ohms.

Maximum IDC Voltage: 11 Volts.

Maximum IDC Current: 240 μ A

EOL resistance: 47K ohms.

Maximum SLC Wiring resistance: 40 Ohms.

Temperature range: 32° to 120°F (0° to 49°C).

Humidity range: 10% to 93% (non-condensing).

Dimensions: 4.5" (11.43 cm) high x 4" (10.16 cm) wide x 2.125" (5.398 cm) deep.

NDM-100(A) AUTOMATIC ADDRESSING

The NDM-100(A) automatically assigns itself to two addressable points, starting with the original address. For example, if the NDM-100(A) is set to address "26", then it will automatically assign itself to addresses "26" and "27".

NOTE: "Ones" addresses on the NDM-100(A) are 0, 2, 4, 6, or 8 only. Terminals 6 and 7 use the first address, and terminals 8 and 9 use the second address.



CAUTION:

Avoid duplicating addresses on the system.

Installation

NMM-100(A), NZM-100(A), and NDM-100(A) modules mount directly to a standard 4" (10.16 cm) square, 2.125" (5.398 cm) deep, electrical box. They may also be mounted to the SMB500 surface-mount box. Mounting hardware and installation instructions are provided with each module. All wiring must conform to applicable local codes, ordinances, and regulations. These modules are intended for power-limited wiring only.

The NMM-100P(A) module is intended to be wired and mounted without rigid connections inside a standard electrical box. All wiring must conform to applicable local codes, ordinances, and regulations.

Agency Listings and Approvals

In some cases, certain modules may not be listed by certain approval agencies, or listing may be in process. Consult factory for latest listing status.

- **UL:** S635
- **ULC:** S635
- **FM Approved**
- **CSFM:** 7300-0028:0230 (NMM-100, NMM-100P, NZM-100); 7300-0028:0237 (NDM-100)

- **MEA:** 72-01-E Vol. 2 (NMM-100, NMM-100P, NZM-100); 227-03-E Vol. 3 (NDM-100)

Product Line Information

NOTE: "A" suffix indicates ULC-listed model.

NMM-100(A): Monitor module.

NMM-100P(A): Monitor module, miniature.

NZM-100(A): Monitor module, two-wire detectors.

NDM-100(A): Monitor module, dual, two independent Class B circuits.

SMB500: Optional surface-mount backbox.

NOTE: See installation instructions and refer to the SLC Wiring Manual, PN 52304.

Input/Output Module, Model(s) FDRM-1

Lamp driver annunciator modules, Model(s) LDM-32(f03), LDM-E32(f03), LDM-R32(f03)

Monitor modules, Model(s) FMM-1, FMM-101, FZM-1, JSM-FMM-101C, JSM-FMM-1C, KM-FZM-1C, NDM-100

Monitoring modules, Model(s) 771103, NC-100, NC-100R, NMM-100, NMM-100P, NZM-100-20

Monitors, Model(s) CRT1, CRT2

Municipal box transmitters, Model(s) MBT-1

Network control annunciators, Model(s) NCA-2

Power Supplies, sub-assemblies, Model(s) APS2-6R, APS2-6RE

Printers, Model(s) PRN-6

Relay modules, Model(s) N-ANN-RLY, XP6-R

Remote alpha annunciators, Model(s) N-RAA

Remote annunciators, Model(s) FDU-80, FDU-80G (f04), LCD-160(f11), LCD-80(f07), N-ANN-80, N-ANN-80W, N-ANN-I/O, ZXR-A, ZXR-P, ZXR4B-UL(f09), ZXR5B-UL(f09)

Remote annunciators, Remote annunciators LCD, Model(s) LCD2-80

Remote LCD annunciators, Model(s) N-ANN-80

Remote microphone modules, Model(s) VEC-RM

Remote microphones, Model(s) RM-1, RM-1SA

Remote notification-circuit expander/battery chargers, Model(s) FCPS-24S6(f12), FCPS-24S6E(f12), FCPS-24S8(f12), FCPS-24S8E(f12)

Remote paging jacks, Model(s) N-FPJ, N-RPJ (f14)

Remote repeater modules, Model(s) RPT-680(f06), RPT-F(f06), RPT-W(f06), RPT-WF(f06)

Remote zone annunciators, Model(s) RZA-4X, RZA-4XF

Repeaters, Model(s) RPT-485W, RPT-485WF

Reverse polarity transmitters, Model(s) RPT-680

Serial/parallel interfaces, Model(s) N-ANN-S/PG

Six zone interface modules, Model(s) NZM-100-6, XP6-MA

Sub-assemblies, Model(s) ACC-AAM25, ACC-EPM, ACC-ZSM, FireVoice-25/50, FireVoice-25/50ZS

Supervising control modules, Model(s) XP6-C

Surface mount boxes, Model(s) SMB500

Transponders, Model(s) XP5-C, XP5-M

Universal zone coder subassembly, Model(s) UZC-256

Voice evacuation/emergency message control panels, Model(s) VEC-25/50, VEC-25/50E, VEC-25/50X, VEC-25/50XE, XPIQ

Zone page modules with keypads, Model(s) NFV-ZPMK (f13) (f14)

Model(s) R-47K

(f02) - x represents the letters A, B, C, or D; y represents the letters B or R

NC-100(A)

Control Module for FireWarden Series Panels

**Addressable**

General

The **NC-100(A)** Addressable Control Module provides NOTIFIER's **FireWarden Series** intelligent control panels a supervised Class B (Style Y) or Class A (Style Z) circuit for Notification Appliances (horns, strobes, etc.). Addressability allows the NC-100(A) to be activated, either manually or through panel programming, on a select (zone or area of coverage) basis.

Features

- Built-in type identification automatically identifies these devices to the control panel.
- Internal circuitry powered directly by two-wire SLC loop. The NC-100(A) module requires power (for horns, strobes, etc.).
- Integral LED "blinks" when communicating, and turns on steady when activated.
- High noise immunity (EMF/RFI).
- The NC-100(A) may be used to switch 24-volt NAC power.
- Wide viewing angle of LED.
- SEMS screws with clamping plates for wiring ease.
- Direct Decade entry of address: 01 – 99 with FireWarden-100-2(C), or 01-50 with the FireWarden-50(C).

Applications

The NC-100(A) is used to switch 24 VDC audible/visual power.

Construction

- The face plate is made of off-white heat-resistant plastic.
- Controls include two rotary switches for direct-dial entry of address setting.
- The NC-100(A) is configured for a single Class B (Style Y) or Class A (Style Z) Notification Appliance Circuit.

Operation

Each NC-100(A) uses one of the module addresses on a SLC loop. It responds to regular polls from the control panel and reports its type and status, including the open/normal/short status of its Notification Appliance Circuit (NAC). The LED blinks with each poll received. On command, it activates its internal relay. The NC-100(A) supervises Class B (Style Y) or Class A (Style Z) notification or control circuits.

Upon code command from the panel, the NC-100(A) will disconnect the supervision and connect the external power supply in the proper polarity across the load device. The disconnection of the supervision provides a positive indication to the panel that the control relay actually turned ON. The external power supply is always relay-isolated from the communication loop so that a trouble condition on the external power supply will never interfere with the rest of the system.

Rotary switches set a unique address for each module. The address may be set before or after mounting. The built-in TYPE CODE (not settable) will identify the module to the control panel.

**NC-100(A)**

Specifications

Normal operating voltage: 15 to 32 VDC.

Maximum SLC current draw: 6.5 mA (LED on).

Average operating current: 350 μ A (LED flashing).

External supply voltage: maximum 80 volts (RMS or DC).

Drain on external supply: 2 mA maximum (using internal EOL relay).

EOL resistance: 47K ohms.

Temperature range: 32°F to 120°F (0°C to 49°C).

Humidity range: 10% to 93% non-condensing.

Dimensions: 4.5" (11.43 cm) high x 4" (10.16 cm) wide x 1.25" (3.175 cm) deep. Mounts to a 4" (10.16 cm) square x 2.125" (5.398 cm) deep box.

Agency Listings and Approvals

In some cases, certain modules may not be listed by certain approval agencies, or listing may be in process. Consult factory for latest listing status.

- **FM approved**
- **UL/ULC Listed:** file S635.
- **CSFM approved:** file 7300-0028:230.
- **MEA approved:** file 72-01-E Vol. 2.

Contact Ratings

Current Rating	Maximum Voltage	Load Description	Application
3 A	30 VDC	Resistive	Non-Coded
2 A	30 VDC	Resistive	Coded
.9 A	110 VDC	Resistive	Non-Coded
.9 A	125 VDC	Resistive	Non-Coded
.5 A	30 VDC	Inductive (L/R=5ms)	Coded
1 A	30 VDC	Inductive (L/R=2ms)	Coded
.3 A	125 VAC	Inductive (PF=0.35)	Non-Coded
1.5 A	25 VAC	Inductive (PF=0.35)	Non-Coded
.7 A	70.7 VAC	Inductive (PF=0.35)	Non-Coded
2 A	25 VAC	Inductive (PF=0.35)	Non-Coded

Product Line Information

NC-100: Intelligent addressable control module.

NC-100(A): Intelligent addressable control module, ULC listed version.

SMB500: Optional surface-mount backbox.

CB500: Optional control module barrier, required by UL for separating power-limited and non-power-limited wiring in the same junction box as NC-100(A).

NOTE: For installation instructions, see document I56-2592-001 and refer to the SLC Wiring Manual, document 52304. The NC-100R(A) relay module, previously on this data sheet, is now on DN-60383.

NOTIFIER® is a registered trademark of Honeywell International Inc. ©2010 by Honeywell International Inc. All rights reserved. Unauthorized use of this document is strictly prohibited.



This document is not intended to be used for installation purposes.
We try to keep our product information up-to-date and accurate.
We cannot cover all specific applications or anticipate all requirements.
All specifications are subject to change without notice.



Made in the U. S. A.

For more information, contact Notifier. Phone: (203) 484-7161, FAX: (203) 484-7118,
www.notifier.com

End of line resistors, Model(s) 401-4901, 401-4902, A2143-00, AZ143-00, ELR-20k, ELR-47K, R-10k, R-3.9k, R-47K

End of line supervision devices, Model(s) REL-2.2K, REL-3.3K, REL-4.7K, REL-47K

Fault isolator modules, Model(s) ISO-X

Fire fighter telephone modules, Model(s) NFV-FFT

Fire fighters phones, Model(s) AFAWS-TELA, AFAWS-TELC

Input monitor modules, Model(s) NMM-100-10, XP10-M

Input/Output Module, Model(s) FDRM-1

Lamp driver annunciator modules, Model(s) LDM-32(f03), LDM-E32(f03), LDM-R32(f03)

Microphone Chassis, Model(s) CMIC-1

Monitor modules, Model(s) FMM-1, FMM-101, FZM-1, JSM-FMM-101C, JSM-FMM-1C, KM-FZM-1C, NDM-100

Monitoring modules, Model(s) 771103, NC-100, NC-100R, NMM-100, NMM-100P, NZM-100-20

Monitors, Model(s) CRT1, CRT2

Municipal box transmitters, Model(s) MBT-1

Network control annunciators, Model(s) NCA-2

Power Supplies, sub-assemblies, Model(s) APS2-6R, APS2-6RE

Printers, Model(s) PRN-6

Relay modules, Model(s) N-ANN-RLY, XP6-R

Remote alpha annunciators, Model(s) N-RAA

Remote annunciators, Model(s) FDU-80, FDU-80G (f04), LCD-160(f11), LCD-80(f07), N-ANN-80, N-ANN-80W, N-ANN-I/O, ZXR-A, ZXR-P, ZXR4B-UL(f09), ZXR5B-UL(f09)

Remote annunciators, Remote annunciators LCD, Model(s) LCD2-80

Remote LCD annunciators, Model(s) N-ANN-80

Remote microphone modules, Model(s) VEC-RM

Remote microphones, Model(s) RM-1, RM-1SA

Remote notification-circuit expander/battery chargers, Model(s) FCPS-24S6(f12), FCPS-24S6E(f12), FCPS-24S8(f12), FCPS-24S8E(f12)

Remote paging jacks, Model(s) N-FPJ, N-RPJ (f14)

Remote repeater modules, Model(s) RPT-680(f06), RPT-F(f06), RPT-W(f06), RPT-WF(f06)

Remote zone annunciators, Model(s) RZA-4X, RZA-4XF

Repeaters, Model(s) RPT-485W, RPT-485WF

Reverse polarity transmitters, Model(s) RPT-680

Serial/parallel interfaces, Model(s) N-ANN-S/PG

Six zone interface modules, Model(s) NZM-100-6, XP6-MA

Sub-assemblies, Model(s) ACC-AAM25, ACC-EPM, ACC-ZSM, FireVoice-25/50, FireVoice-25/50ZS

Supervising control modules, Model(s) XP6-C

NC-100R(A)**Relay Module for
FireWarden Series Panels****Addressable****General**

The **NC-100R(A)** Addressable Relay Module provides NOTIFIER's **FireWarden Series** intelligent control panels with two isolated sets of Form-C dry-contact outputs for activating a variety of auxiliary devices, such as fans, dampers, door holders, control equipment, etc. Addressability allows the dry contact to be activated, either manually or through panel programming, on a select basis.

Features

- Built-in type identification automatically identifies these devices to the control panel.
- Internal circuitry and relay powered directly by two-wire SLC loop.
- Integral LED "blinks" green each time a communication is received from the control panel and turns on in steady when activated.
- High noise immunity (EMF/RFI).
- Wide viewing angle of LED.
- SEMS screws with clamping plates for wiring ease.
- Direct Decade entry of address: 01 – 99 with the FireWarden-100-2(C) and 01 – 50 with the FireWarden-50(C).

Applications

The NC-100R(A) may be programmed to operate dry contacts for door holders, Air Handling Unit shutdown, etc., and to reset four-wire smoke detector power.

Construction

- The face plate is made of off-white heat-resistant plastic.
- Controls include two rotary switches for direct-dial entry of address setting.
- The **NC-100R(A)** provides two Form-C dry contacts that switch together.

Operation

Each NC-100R(A) uses one of the addresses on a SLC loop. It responds to regular polls from the control panel and reports its type and status. The LED blinks with each poll received. On command, it activates its internal relay.

Rotary switches set a unique address for each module. The address may be set before or after mounting. The built-in TYPE CODE (not settable) will identify the module to the control panel.

**NC-100R(A)****Specifications**

Normal operating voltage: 15 to 32 VDC.

Maximum SLC current draw: 6.5 mA (LED).

Average operating current: 230 μ A direct poll (CLIP mode), 255 μ A group poll with LED flashing.

EOL resistance: not used.

Temperature range: 32°F to 120°F (0°C to 49°C).

Humidity range: 10% to 93% non-condensing.

Dimensions: 4.5" (11.43 cm) high x 4" (10.16 cm) wide x 1.25" (3.175 cm) deep. Mounts to a 4" (10.16 cm) square x 2.125" (5.398 mm) deep box.

Relay Contact Ratings

Load Description	Application	Maximum Voltage	Current Rating
Resistive	Non-Coded	30 VDC	3.0 A
Resistive	Coded	30 VDC	2.0 A
Resistive	Non-Coded	110 VDC	0.9 A
Resistive	Non-Coded	125 VAC	0.9 A
Inductive (L/R=5ms)	Coded	30 VDC	0.5 A
Inductive (L/R=2ms)	Coded	30 VDC	1.0 A
Inductive (PF=0.35)	Non-Coded	125 VAC	0.5 A

Agency Listings and Approvals

In some cases, certain modules may not be listed by certain approval agencies, or listing may be in process. Consult factory for latest listing status.

- **UL/ULC Listed:** S635.
- **CSFM approved:** file 7300-0028:230.
- **FM approved.**
- **MEA approved:** file 72-01-E, Vol. 2.

Product Line Information

NC-100R: Intelligent addressable relay module.

NC-100RA: Intelligent addressable relay module, ULC listed model.

SMB500: Optional surface-mount backbox.

NOTE: For installation instructions, see document 156-2593-001 and refer to the SLC Wiring Manual, document 52304.

NOTIFIER® is a registered trademark of Honeywell International Inc. ©2010 by Honeywell International Inc. All rights reserved. Unauthorized use of this document is strictly prohibited.



This document is not intended to be used for installation purposes.
We try to keep our product information up-to-date and accurate.
We cannot cover all specific applications or anticipate all requirements.
All specifications are subject to change without notice.



Made in the U. S. A.

For more information, contact Notifier. Phone: (203) 484-7161, FAX: (203) 484-7118,
www.notifier.com

End of line resistors, Model(s) 401-4901, 401-4902, A2143-00, AZ143-00, ELR-20k, ELR-47K, R-10k, R-3.9k, R-47K

End of line supervision devices, Model(s) REL-2.2K, REL-3.3K, REL-4.7K, REL-47K

Fault isolator modules, Model(s) ISO-X

Fire fighter telephone modules, Model(s) NFV-FFT

Fire fighters phones, Model(s) AFAWS-TELA, AFAWS-TELC

Input monitor modules, Model(s) NMM-100-10, XP10-M

Input/Output Module, Model(s) FDRM-1

Lamp driver annunciator modules, Model(s) LDM-32(f03), LDM-E32(f03), LDM-R32(f03)

Microphone Chassis, Model(s) CMIC-1

Monitor modules, Model(s) FMM-1, FMM-101, FZM-1, JSM-FMM-101C, JSM-FMM-1C, KM-FZM-1C, NDM-100

Monitoring modules, Model(s) 771103, NC-100, **NC-100R**, NMM-100, NMM-100P, NZM-100-20

Monitors, Model(s) CRT1, CRT2

Municipal box transmitters, Model(s) MBT-1

Network control annunciators, Model(s) NCA-2

Power Supplies, sub-assemblies, Model(s) APS2-6R, APS2-6RE

Printers, Model(s) PRN-6

Relay modules, Model(s) N-ANN-RLY, XP6-R

Remote alpha annunciators, Model(s) N-RAA

Remote annunciators, Model(s) FDU-80, FDU-80G (f04), LCD-160(f11), LCD-80(f07), N-ANN-80, N-ANN-80W, N-ANN-I/O, ZXR-A, ZXR-P, ZXR4B-UL(f09), ZXR5B-UL(f09)

Remote annunciators, Remote annunciators LCD, Model(s) LCD2-80

Remote LCD annunciators, Model(s) N-ANN-80

Remote microphone modules, Model(s) VEC-RM

Remote microphones, Model(s) RM-1, RM-1SA

Remote notification-circuit expander/battery chargers, Model(s) FCPS-24S6(f12), FCPS-24S6E(f12), FCPS-24S8(f12), FCPS-24S8E(f12)

Remote paging jacks, Model(s) N-FPJ, N-RPJ (f14)

Remote repeater modules, Model(s) RPT-680(f06), RPT-F(f06), RPT-W(f06), RPT-WF(f06)

Remote zone annunciators, Model(s) RZA-4X, RZA-4XF

Repeaters, Model(s) RPT-485W, RPT-485WF

Reverse polarity transmitters, Model(s) RPT-680

Serial/parallel interfaces, Model(s) N-ANN-S/PG

Six zone interface modules, Model(s) NZM-100-6, XP6-MA

Sub-assemblies, Model(s) ACC-AAM25, ACC-EPM, ACC-ZSM, FireVoice-25/50, FireVoice-25/50ZS

Supervising control modules, Model(s) XP6-C



Multi-Voltage Conventional Relays

System Sensor's multi-voltage conventional relays are used for high-current switching applications such as fan and damper assembly control, door control, air handling unit controls, and other types of system interfacing.

Features

- Multi-voltage operation
- Activation LEDs
- Easy and flexible installation
- Reliable and robust design
- Multipurpose field installations
- Multi-voltage relays with terminal strip field wiring connections, mounting track, and hardware for R-10T/20T and R-14T/24T
- Removable front cover on steel enclosure for R-10E/R-20E and R-14/R-24E, which mount inside the enclosure
- LED viewing hole on top of the steel enclosure's cover
- Extra pair of wires for redundant power input on PR-3
- Terminal strip field wiring connections, mounting track, and hardware



The R-10T, R-20T, R-14T, and the R-24T models are multi-voltage relays with terminal strip field wiring connections, mounting track, and hardware. The R-10T is a single FORM-C (SPDT) relay with a red activation LED, and the R-14T is a four-gang 1 FORM-C (SPDT) relay with four red activation LEDs. The R-20T is a single 2 FORM-C (DPDT) relay with a red activation LED, and the R-24T is a four-gang 2 FORM-C (DPDT) relay with four red activation LEDs.

The R-10E/R-20E and R-14E/R-24E are similar to the T-series track mount relays, but they are mounted into a steel enclosure. The enclosure has a removable front cover that provides easy access and an LED viewing hole on the top of the cover.

PR-1/PR-2/PR-3 are epoxy encapsulated multi-voltage relays. They are single-pole double-throw relays that use a red LED as a visible indication of relay coil energization. PR-3 is identical to PR-2, except it has an extra pair of wires for redundant power input.

Model EOLR-1 is an epoxy encapsulated, single-pole single-throw, normally open relay that can be used as an end of line device in fire alarm systems, e.g. to supervise power supplies.

Agency Listings



MEA
approved

Multi-Voltage Conventional Relay Specifications

Specifications: R-10T/R-14T/R-20T/R-24T	
Operating Voltage	18 – 35 VDC, 18 – 35 VAC, 115 VAC, 230 VAC
Operating Current	20 mA DC max. @ 24 VDC, 24 VAC, 115 VAC, 230 VAC (R-10T/R-14T) 40 mA DC max. @ 24 VDC, 24 VAC, 115 VAC, 230 VAC (R-20T/R-24T)
Operating Temperature	–40°F to 158°F (–40°C to 70°C)
Humidity Range	10% – 93% non-condensing
Dimensions	R-10T/R-20T: 2.5" L × 3.35" W × 1.2" H R-14T/R-24T: 10" L × 3.35" W × 1.2" H
Contact Ratings	24 VDC: 7 A with L/R = 5 mS 120 VAC: 10 A 120 VAC: 1/6 HP 230 VAC: 7 A
Specifications: R-10E/R-14E/ R-20E/R-24E	
Operating Voltage	18 – 35 VDC, 18 – 35 VAC, 115 VAC, 230 VAC
Operating Current	20 mA DC max. @ 24 VDC, 24 VAC, 115 VAC, 230 VAC (R-10E/R-14E) 40 mA DC max. @ 24 VDC, 24 VAC, 115 VAC, 230 VAC (R-20E/R-24E)
Operating Temperature	–40°F to 158°F (–40°C to 70°C)
Humidity Range	10% – 93% non-condensing
Dimensions	R-10E/R-20E: 5.1" L × 3.75" W × 2.5" H R-14E/R-24E: 11" L × 5.3" W × 2.5" H
Contact Ratings	24 VDC: 7 A with L/R = 5 mS 120 VAC: 10 A 120 VAC: 1/6 HP 230 VAC: 7 A

Specifications: PR-1	
Operating Voltage	18 – 35 VDC, 18 – 35 VAC, 120 VAC
Operating Current	15 mA DC max. @ 24 VDC, 24 VAC, 120 VAC
Operating Temperature	–40°F to 158°F (–40°C to 70°C)
Humidity Range	10 – 93% RH
Wire Length	8" minimum
Dimensions	0.87" H × 2.01" W × 1.42" D
Contact Ratings	24 VDC: 7 A with L/R = 5 mS 120 VAC: 7 A max. (0.35 PF) 250 VAC: 10 A resistive 30 VDC: 10 A resistive

Specifications: PR-2/PR-3	
Operating Voltage	10 to 40 VDC
Operating Current	30 mA DC max.
Operating Temperature	–40°F to 158°F (–40°C to 70°C)
Humidity Range	10 – 93% RH
Wire Length	8" minimum
Dimensions	0.91" H × 1.65" W × 1.22" D
Contact Ratings	120 VAC: 10 A max. (resistive load) 120 VAC: 7 A max. (0.35 PF) 250 VAC: 10 A max. (resistive load) 30 VDC: 10 A max. (resistive load)

Specifications: EOLR-1	
Operating Voltage	9 to 40 VDC
Operating Current	20 mA DC max.
Operating Temperature	–22°F to 140°F (–30°C to 60°C)
Humidity Range	10 – 93% RH
Wire Length	8" minimum
Contact Ratings	120 VAC: 0.5 A max. (resistive load) 30 VDC: 3 A max. (resistive load)



PR-1



EOLR-1



PR-3



R-10E & R-20E Enclosure



PR-2



R-10T



R-14T



R-14E & R-24E Enclosure



3825 Ohio Avenue • St. Charles, IL 60174
Phone: 800-SENSOR2 • Fax: 630-377-6495

©2007 System Sensor.
Product specifications subject to change without notice. Visit systemsensor.com for current product information, including the latest version of this data sheet.
A05-0372-005 • 3/07 • #1782

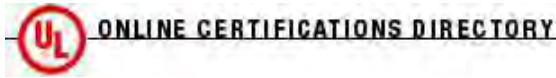

UOXX.S3705 Control Unit Accessories, System

[Page Bottom](#)

Control Unit Accessories, System

[See General Information for Control Unit Accessories, System](#)

SYSTEM SENSOR UNINCORPORATED, DIV OF HONEYWELL INTERNATIONAL INC
3825 OHIO AVE
ST CHARLES, IL 60174 USA

S3705

Addressable monitor modules, Model(s) M300, M301, M500M, M500MC

Dual monitor modules, Model(s) M500DM

Enclosures, Model(s) BB-2, BB-6

End-of-line capacitors, Model(s) A2143-20

End-of-line supervision relays, Model(s) EOLR-1

Fault isolator modules, Model(s) M500X

Input monitor modules, Model(s) IM-10

Input/Output Module, Model(s) M500DMR1

Maintenance modules, Model(s) 2W-M0D2, 2W-MOD

Monitor module, Model(s) HFS-MM, HFS-MMA

Monitor modules, Model(s) EM-1M, EM-1MI, EM-1MM, EM-1MMI, M500DR, M500FP, M500MB, M500R (a), M500S(a), M500SC, M501M, M501MC, M502M, M502MC

Multi-voltage relays, Model(s) PR-1, PR-2, PR-3, R-10T/R-10E, R-14T/R-14E, R-20T/R-20E, R-24T/R-24E

Polarity reversal modules, Model(s) RR2, RRS-M0D

Relay modules, Model(s) CR-6, EM-1R, EM-1RI, HFS-MR, HFS-MRA

Six zone interface modules, Model(s) CZ-6

Supervising control modules, Model(s) EM-1SR, EM-1SRI, SC-6

Surface-mount boxes, Model(s) SMB500

Synchronization cards, Model(s) SYNC-1

Telephone interface modules, Model(s) FTM-1

Model(s) DNRW

(a) - Modules can be installed in the DNR duct housing.

[Last Updated](#) on 2011-10-18

[Questions?](#)

[Print this page](#)

[Terms of Use](#)

[Page Top](#)



L-Series and L-Series with LED Indoor Selectable Horns, Strobes and Horn Strobes

System Sensor L-Series and L-Series with LED audible visible notification products are rich with features guaranteed to cut installation times and maximize profits with lower current draw and modern aesthetics.



Features

- LED technology provides lower current draw
- Digital Voltage Meter (DVM) diagnostic test points for Horn Strobes and Strobes
- Common aesthetics across the L-Series platform
- Standard and compact sizes
- Tamper-resistant construction
- Field-selectable candela settings on wall units: 15, 30, 75, 95, 110, 135, and 185
- Field-selectable candela settings on ceiling units: 15, 30, 75, 95, 115, 150, and 177
- Rotary switches for candela, tone and volume selections
- Mounting plate provides plug-in design for easier installation and shorting springs to check wiring continuity
- Electrically compatible with legacy SpectrAlert, SpectrAlert Advance and L-series devices
- Synchronization through use of UL approved power supplies that support System Sensor Sync protocol or System Sensor MDL3 Sync Module
- Horns, Strobes and Horn Strobes listed for wall or ceiling use

The System Sensor L-Series and L-Series with LED

platform offers the most versatile and easy-to-use line of horns, strobes, and horn strobes in the industry with lower current draw and modern aesthetics. LED lighting technology offers significantly lower current draw compared to older Xenon bulbs across a full candela range. This improves design flexibility for notification appliance circuits (NACs) while also reducing power supply requirements allowing for simpler and lower cost installations.

Flexible design options meet virtually any application requirement: wall or ceiling mount, standard or compact sizes, red or white color choices, bezel kits for alternate markings and languages, and LED color lenses for distinctive visual signaling. In addition, installers can easily adapt devices using field selectable candela, tone and volume settings using rotary switches.

The L-Series and L-Series with LED line is developed to simplify installation. All devices feature plug-in designs with minimal intrusion into the back box, making installations fast and foolproof while virtually eliminating costly and time-consuming ground faults. The universal mounting plate includes an onboard shorting spring, so installers can test wiring continuity before the device is installed.

In addition, the System Sensor L-Series with LED notification appliances offer a new diagnostic test point feature that allows you to measure device voltage with a digital voltage meter (DVM) without removing the appliance from the wall or ceiling. The DVM test points are discreetly located on the face of the notification appliance which enable faster troubleshooting and end of line (EOL) voltage checks while greatly reducing the risk of misplacing or damaging appliances during troubleshooting.

Agency Listings



L-Series and L-Series with LED Specifications

Physical/Electrical Specifications	
Standard Operating Temperature	32°F to 120°F (0°C to 49°C)
Humidity Range	10 to 93% non-condensing
Strobe Flash Rate	1 flash per second
Nominal Voltage, LED Strobes and Horn Strobes	Regulated 24 VDC
Nominal Voltage, Horns	Regulated 12 VDC or regulated 24 DC/FWR
Operating Voltage Range, LED Strobes and Horn Strobes	16 to 33 V (24 V nominal)
Operating Voltage Range, Horns	8 to 17.5 V (12 V nominal) or 16 to 33 V (24 V nominal)
Input Terminal Wire Gauge	12 to 18 AWG

UL/ULC Current Draw Data, Horn Tones, and Sound Output Data

UL/ULC Maximum Strobe Current Draw (mA)			
Candela Range	Candela Rating	16–33 Volts	
		Wall	Ceiling
Candela Range	15	18	18
	30	22	22
	75	70	70
	95	75	75
	110	85	—
	115	—	90
	135	105	—
	150	—	110
	177	—	115
	185	120	—

UL/ULC Maximum Horn Current Draw (mA RMS)				
Sound Pattern	dB	8–17.5 Volts		
		DC	DC	FWR
Temporal	High	39	44	54
Temporal	Low	28	32	54
Non-Temporal	High	43	47	54
Non-Temporal	Low	29	32	54
3.1 KHz Temporal	High	39	41	54
3.1 KHz Temporal	Low	29	32	54
3.1 KHz Non-Temporal	High	42	43	54
3.1 KHz Non-Temporal	Low	28	29	54
Coded	High	43	47	54
3.1 KHz Coded	High	42	43	54

UL/ULC Maximum Horn Strobe Current Draw (mA) and Sound Output (dBA)													
Switch Pos.	Sound Pattern	Volume Setting	Current Draw (mA RMS), Horn Strobe, Candela Range (15-185 cd)										Sound Output (dBA)
			16-33 Volts										16-33V
			15cd	30cd	75cd	95cd	110cd	115cd	135cd	150cd	177cd	185cd	DC
			WALL	CEILING	WALL	CEILING	WALL	CEILING	CEILING	WALL			
1	Temporal 3	High	35	38	87	92	94	120	189	189	190	190	87
2	Temporal 3	Low	35	38	87	92	94	120	135	135	145	145	79
3	Non-Temporal	High	50	52	87	92	94	120	127	127	135	135	87
4	Non-Temporal	Low	35	38	87	92	94	120	125	125	130	130	79
5	3.1KHz Temporal 3	High	35	38	87	89	91	115	155	155	165	165	86
6	3.1KHz Temporal 3	Low	35	38	87	89	91	115	128	130	135	135	80
7	3.1KHz Non-Temporal	High	40	42	87	89	91	115	125	125	135	135	86
8	3.1KHz Non-Temporal	Low	35	38	87	89	91	115	120	120	130	130	80

L-Series with LED Dimensions: Wall-Mounted Equipment

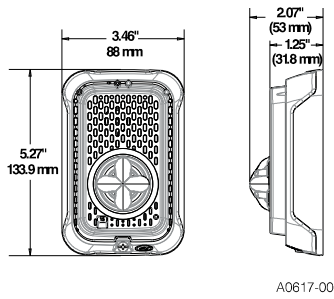

A0617-00

**Compact Strobe, Horn Strobe
for Wall**

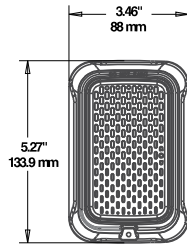

A0547-00

Compact Horn

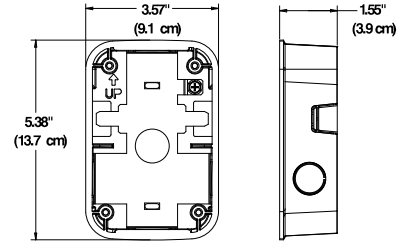

A0557-00

**Compact Surface Mount Back Box
for Walls (SBBGRL, SBBGWL)**

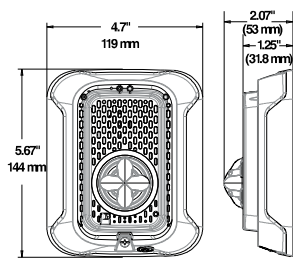

A0613-00

**Strobes, Horn Strobes
for Walls**

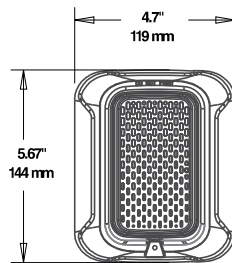

A0549-00

Horn

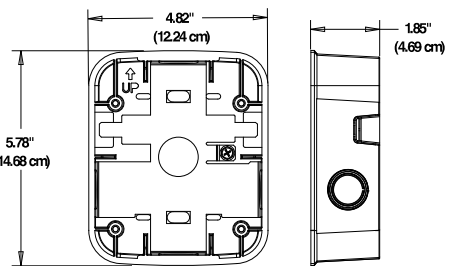

A0554-01

**Surface Mount Back Box
for Walls (SBBRL/SBBWL)**

L-Series with LED Dimensions: Ceiling-Mounted Equipment

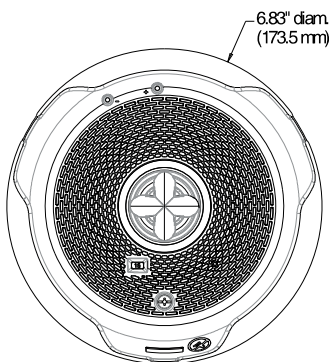

A0608-00

**Strobes and Horn Strobes
for Ceilings**

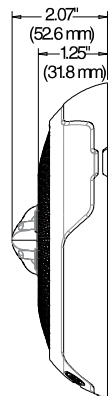

6.92" diam
(175.77 mm)

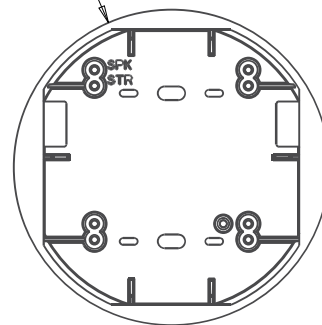

A0546-00

**Surface Mount Back Box
for Ceilings (SBBCL, SBCWL)**

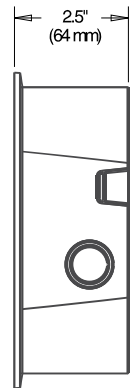

L-Series with LED: Ordering Information

Model	Description
L-Series with LED Horn Strobes	
P2RLED	2-Wire, Horn Strobe, Wall, Red
P2RLED-B	2-Wire, Horn Strobe, Wall, Red, Bilingual
P2WLED	2-Wire, Horn Strobe, Wall, White
P2WLED-B	2-Wire, Horn Strobe, Wall, White, Bilingual
P2GRLED	2-Wire, Compact Horn Strobe, Wall, Red
P2GRLED-B	2-Wire, Compact Horn Strobe, Wall, Red, Bilingual
P2GWLED	2-Wire, Compact Horn Strobe, Wall, White
P2GWLED-B	2-Wire, Compact Horn Strobe, Wall, White, Bilingual
P2RLED-P	2-Wire, Horn Strobe, Wall, Red, Plain
P2WLED-P	2-Wire, Horn Strobe, Wall, White, Plain
P2RLED-SP	2-Wire, Horn Strobe, Wall, Red, FUEGO
P2WLED-SP	2-Wire, Horn Strobe, Wall, White, FUEGO
PC2RLED	2-Wire, Horn Strobe, Ceiling, Red
PC2RLED-B	2-Wire, Horn Strobe, Ceiling, Red, Bilingual
PC2WLED	2-Wire, Horn Strobe, Ceiling, White
PC2WLED-B	2-Wire, Horn Strobe, Ceiling, White, Bilingual
L-Series with LED Strobes	
SRLED	Strobe, Wall, Red
SRLED-B	Strobe, Wall, Red, Bilingual
SWLED	Strobe, Wall, White
SWLED-B	Strobe, Wall, White, Bilingual
SGRLED	Strobe, Compact, Wall, Red
SGRLED-B	Strobe, Compact, Wall, Red, Bilingual
SGWLED	Strobe, Compact, Wall, White
SGWLED-B	Strobe, Compact, Wall, White, Bilingual
SRLED-P	Strobe, Wall, Red, Plain
SWLED-P	Strobe, Wall, White, Plain
SRLED-SP	Strobe, Wall, Red, FUEGO
SWLED-CLR-ALERT	Strobe, Wall, White, ALERT
SWLED-ALERT	Strobe, Wall, White, ALERT, Amber Lens
SCRLED	Strobe, Ceiling, Red
SCRLED-B	Strobe, Ceiling, Red, Bilingual
SCRLED-P	Strobe, Ceiling, White, Plain
SCWLED	Strobe, Ceiling, White
SCWLED-B	Strobe, Ceiling, White, Bilingual
SCWLED-P	Strobe, Ceiling, White, Plain
SCWLED-CLR-ALERT	Strobe, Ceiling, White, ALERT
L-Series Horns	
HRL*	Horn, Red
HRLA*	Horn, Red, Plain, ULC
HWL*	Horn, White
HWLA*	Horn, White, Plain, ULC
HGRLED*	Compact Horn, Red
HGRLED-A*	Compact Horn, Red, Plain, ULC
HGWLED*	Compact Horn, White
HGWLED-A*	Compact Horn, White, Plain, ULC

Model	Description
LED Lenses	
LENS-A3	Lens LED Amber Wall/Ceiling
LENS-B3	Lens LED Blue Wall/Ceiling
LENS-G3	Lens LED Green Wall/Ceiling
LENS-R3	Lens LED Red Wall/Ceiling
Accessories	
TR-2	Universal Wall Trim Ring Red
TR-2W	Universal Wall Trim Ring White
SBBRL	Wall Surface Mount Back Box, Red
SBBWL	Wall Surface Mount Back Box, White
SBBGRL	Compact Wall Surface Mount Back Box, Red
SBBGWL	Compact Wall Surface Mount Back Box, White
TRC-2	Universal Ceiling Trim Ring, Red
TRC-2W	Universal Ceiling Trim Ring, White
SBBCRL	Ceiling Surface Mount Back Box, Red
SBBCWL	Ceiling Surface Mount Back Box, White
Bezels†	
BZR	Wall Red Bezel Kit
BZW	Wall White Bezel Kit
BZGR	Compact Wall Red Bezel Kit
BZGW	Compact Wall White Bezel Kit
BZRC	Horn Strobe Ceiling Red Bezel Kit
BZWC	Horn Strobe Ceiling White Bezel Kit

Notes for L-Series With LED Horn Strobes and Strobes:

All -P models have a plain housing (no "FIRE" marking on cover).
 All -SP models have "FUEGO" marking on cover.
 All -ALERT models have "ALERT" marking on cover.
 All -B models have "FIRE/FEU" marking on cover for use in Canadian applications.
 Amber lenses are not for use in Canadian applications

Notes for L-Series Horns:

*Horn-only models are listed for wall or ceiling use.

Notes for Bezels:

†Each bezel pack ships in a package of 5.
 Add one of the following extensions for print/language options: -F (FIRE), -AL (ALERT), -EV (EVAC), -AG (AGENT), -P (Plain), -FR (FEU), -PG (FOGO), -SP (FUEGO), -SPE (FUEGO/FIRE).

3825 Ohio Avenue • St. Charles, IL 60174 USA
 Phone: 800-SENSOR2 • Fax: 630-377-6495
 www.systemsensor.com

System Sensor® is a registered trademark
 of Honeywell International, Inc.



3333 Unity Drive, Mississauga, ON L5L 3S6 Canada
 Phone: 800-SENSOR2 • Fax: 905-812-0771
 www.systemsensor.ca

©2023 System Sensor.
 Product specifications subject to change without notice. Visit systemsensor.com
 for current product information, including the latest version of this data sheet.
 AVDS916-01 • 10/03/2023

Audible-signal Appliances

COMPANY

System Sensor Unincorporated, Div of Honeywell International Inc

3825 Ohio Ave

Saint Charles, IL 60174-5467 United States

S4011

Bells, vibrating, Models SSM24-6, SSM24-8, SSM24-10, SSV120-6, SSV120-8, SSV120-10 for outdoor use when used with NEMA 3R weather resistant back box, Model WBB.

Chimes, Model CH12/24 for indoor use private mode only; Model WBB for outdoor use.

Models CHR, CHW, CHRA, CHWA. For indoor use, private mode use only.

Chimes/strobes, Models CH24MC, CH24MCW. For wall mount, indoor use.

Models CHSR, CHSW. For indoor use only, private mode use only.

Horns, Model PA400W with or without suffix -F. For indoor use only.

Models HR, HW. Intended for indoor use mounted on the wall or ceiling.

Models MHR, MHW. For indoor use only.

Tones 1, 2, 3 and 4 are Public Mode at 24V DC/FWR.

Tone 3 is Public Mode at 12V DC.

Tones 1, 2 and 4 are Private Mode at 12V DC.

Tones 1, 2, 3 and 4 are Private Mode at 12V FWR.

Model APA151. For indoor use only. Public mode.

Mini-Horn, Model MHR1, Input: 8 - 33 Vdc, 8 - 33 Vfwr; for indoor use only.

Sounder/strobes, Model P2475RL . May employ "W" or "Z" suffix. For indoor wall mount only.

Model P12015K for indoor or outdoor use.

Directional sounders, Model PF24V for supplemental fire alarm use. Indoor use only.

520 Hz Low frequency sounders, Models HR-LF, HW-LF. Intended for indoor use only and may be mounted on the wall or the ceiling.

520 Hz Low frequency sounders/strobes, Models P2RH-LF, P2WH-LF. Intended for indoor use only and may be mounted on the wall or the ceiling.

SPECTRALERT ADVANCE SERIES HORNS, CHIMES AND COMBOS

***General** - Models with "K" in the suffix are suitable for indoor or outdoor use with an operating temperature rating of -40°C to +66°C (-40°F to +151°F) and have a NEMA Type 3, 3R and 4X enclosure ratings only when used with the Listed Plastic models SA-WBB and SA-WBBW (wall) or the Plastic models SA-WBBC and SA-WBBCW (ceiling) weatherproof back boxes. Models with "-P" in the suffix have plain housings with no lettering on the enclosure. Models not containing either "-P", in the suffix have English lettering reading "FIRE" on the housing. Models with the "-SP" suffix have Spanish lettering reading "FUEGO" on the housing. Models with the "-PG" suffix have Portuguese lettering reading "FOGO" on the housing.

Horns - Models HR, HW. Intended for indoor use mounted on the wall or ceiling, Models HRK, and HWK, intended for indoor or outdoor use, mounted on the wall or ceiling. *

Horns, Models HWL-LF(a), HRL-LF(a), HGWL-LF(a), HGRL-LF(a) Intended for indoor use mounted on the wall.

Horns, Models HCWL-LF(a), HCRL-LF(a) Intended for indoor use mounted on the ceiling.

Chimes - Models CHR, CHW are intended for private mode only. Intended for indoor use mounted on the wall or ceiling.

Chime/Strobes - Models CHSR, CHSW are intended for private mode only. Intended for indoor use mounted on the wall or ceiling.

Horn/Strobes - Two-wire type, rectangular enclosure, Models P2R, P2W, P2RH, P2WH. Intended for indoor use mounted on the wall or ceiling, Models P2RK, P2RK-R, P2RK-P, P2WK, P2WK-R, P2WK-P, P2RHK, P2RHK-R, P2RHK-P, P2WHK, P2WHK-R, P2WHK-P, intended for indoor and outdoor use, mounted on the wall or ceiling *.

Horn/Strobes - Two-wire type, round enclosure, Models PC2R, PC2W, PC2RH, PC2WH. Intended for indoor use mounted on the wall or ceiling, Models PC2RK, PC2RK-R, PC2RK-P, PC2WK, PC2WK-R, PC2WK-P, PC2RHK, PC2RHK-R, PC2RHK-P, PC2WHK, PC2WHK-R, PC2WHK-P, intended for indoor and outdoor use, mounted on the wall or ceiling *.

Horn/Strobes, Two-wire type, rectangular enclosure, Models P2WL-LF(a) and P2RL-LF(a) Intended for indoor use mounted on the wall. Round enclosure, Models PC2RL-LF and PC2WL-LF intended for indoor use mounted on the ceiling.

Horn/Strobes - Four-wire type, rectangular enclosure, Models P4R, P4W, P4RH, P4WH. Intended for indoor use mounted on the wall or ceiling, Models P4RK, P4WK, P4RHK and P4WHK, intended for outdoor use, mounted on the wall or ceiling *.

Horn/Strobes - Four-wire type, round enclosure, Models PC4R, PC4W, PC4RH, PC4WH. Intended for indoor use mounted on the wall or ceiling, Models PC4RK, PC4WK, PC4RHK, P4WHK-P and PC4WHK, intended for outdoor use, mounted on the wall or ceiling *.

GLOBAL AV COMBO PRODUCT SERIES HORNS, STROBES AND COMBOS:

General - Models for indoor wall and ceiling mount only and for use with an operating temperature of 0°C to +49°C (32°F to +120°F). Models with "R" in the suffix implement a red strobe lens.

Horn/Strobes - Two-wire type, rectangular enclosure, Models SYS-HS, SYS-HSR, SYS-HSR-FIRE, SYS-HSW, SYS-HSRW, SYS-HSRW-FIRE. Intended for indoor use mounted on the wall or ceiling.

Accessories:

Back box, Model WBBF for indoor/outdoor use.

Models SA-WBB, SA-WBBC (Back boxes for Spectralert Advance Series) for indoor/outdoor use.

Weatherproof plates, Models WTP, WTPW, WTP-SP, WTP-SPW, with a NEMA Type 3R and IP22 enclosure ratings. May be used in place of the listed weatherproof back boxes as follows:

Models WTP (Red), WTPW (White) Weatherproof Plates used with horn and horn/strobes models with "K" suffix, suitable for indoor or outdoor flush mount usage, wall or ceiling, with an extended operating temperature range of -40 degrees F to 151 degrees F (-40 degrees C to 66 degrees C). They can be mounted to 2 inch by 4 inch or 4 inch by 4 inch back boxes, with a 1-1/2 inch minimum depth.

Models WTP-SP (Red), WTP-SPW (White) Weatherproof Plates used with speakers and speaker/strobes models with "K" suffix, suitable for indoor or outdoor use flush mount usage, wall or ceiling, with an operating temperature rating of -40 degrees F to 151 degrees F (-40 degrees C to 66 degrees C). They can only be mounted to a 4 inch by 4 inch by 2-1/8 inch back box.

Sync modules, Models MDL3R, MDL3W, MDL, MDLW.

Models MDL3R, MDL3W are also Listed under Audible-signal Appliances (ULSZ).

120 VAC adapter mounting plate, Model MP120K may be used with Models P2R, P2RH, P2RK, P2RHK, P2W, P2WH, SR, SRH, SRK, SRHK, SW, SWH, PC2R, PC2RH, PC2RK, PC2RHK, PC2W, PC2WH, SCR, SCRH, SCRK, SCRHK, SCW, SCWH, HR, HRK, HW, SR-P, SW-P, SRH-P, SWH-P, P2R-P, P2W-P, P2RH-P, P2WH-P, SCR-P, SCW-P, SCRH-P, SCWH-P, PC2R-P, PC2W-P, PC2RH-P, PC2WH-P, SR-SP, SRH-SP, P2R-SP, P2RH-SP, SCW-SP, SCWH-SP, PC2W-SP, PC2WH-SP, CHR, CHW, CHSR, CHSW.

Smoke detector audible bases, Models B501BH, B501BHT, B501BH-2, B501BHT-2.

Wireless AV Base, Ceiling, Models WAV-CRL and WAV-CWL (***) ; and Wall, Models WAV-RL and WA-WL (***) .

Audible signal appliance accessories, accessory retrofit trim plates, Models RFP, RFPW. Optional with Series H horns, Series CH Chimes, Series CHS Chime/Strobes, Series P2 Horn/Strobes, Series PC2 Horn/Strobes, Series P4 Horn/Strobes, and Series PC4 Horn/Strobes.

Audible signal appliance accessories, accessory trim rings, Models TR-HS, TRW-HS, TRC-HS, TRCW-HS. Optional with Series H horns, Series CH Chimes, Series CHS Chime/Strobes, Series P2 Horn/Strobes, Series PC2 Horn/Strobes, Series P4 Horn/Strobes, and Series PC4 Horn/Strobes.

Ceiling trim ring, Optional with Models SYS-HS, SYS-HSR, SYS-HSR-FIRE, SYS-ST, SYS-STR.

Ceiling trim plates, Models SYS-CTP, SYS-CTPR, SYS-CTPR-FIRE, SYS-CTPW, SYS-CTPRW, SYS-CTPRW-FIRE.

Horns*, Models HWL**, HRL**, HGRL**, HGWL**.

Chimes*, Models CHWL**, CHRL**.

Horn Strobes*, Models P2RL, P4RL, P2WL, P4WL, P2GRL, P2GWL, P2RL-P, P2WL-P, P2RL-SP, P2WL-SP, PC2RL, PC4RL, PC2WL, PC4WL.

Chime Strobes*, Models CHSRL, CHSWL, CHSCRL, CHSCWL.

Horn Strobes, Models P2RLED, P2WLED, P2RLED-B, P2RLED-B, P2RLED-P, P2WLED-P, P2RLED-SP, P2WLED-SP, PC2RLED, PC2WLED, PC2RLED-B, PC2WLED-B, P2GRLED, P2GWLED, P2GRLED-B, P2GWLED-B

Horns ()** (b) (c), Models HGRKL, HGRKL-B.

Low Frequency Sounder – HRL2-LF, HWL2-LF, HGRL2-LF, HGWL2-LF, HRLA-LF, HWLA-LF intended for Wall Mount, indoor use.

Low Frequency Sounder – HCRL2-LF, HCWL2-LF, HCRLA-LF, HCWLA-LF intended for Ceiling Mount, indoor use.

Horn Strobes (b) (c), Models P2GRKLED, P2GRKLED-P, P2GRKLED-B, P2GWKLED, P2GWKLED-P, P2GWKLED-B. Intended for Wall Mount.

Horn Strobes (b) (c), Models PC2RKLED, PC2RKLED-P, PC2RKLED-B, PC2WKLED, PC2WKLED-P, PC2WKLED-B. Intended for Ceiling Mount.

Chime/Strobes - Models CHSRLED, CHSRLED-B, CHSWLED, CHSWLED-B are intended for private mode only. Intended for indoor use mounted on the wall.

Chime/Strobes - Models CHSCRLLED, CHSCRLLED-B, CHSCWLED, CHSCWLED-B are intended for private mode only. Intended for indoor use mounted on the Ceiling.

Low Frequency Sounder/Strobes – Models P2RLED-LF, P2WLED-LF, P2RLED-B-LF, P2WLED-B-LF intended for Wall Mount, indoor use.

Low Frequency Sounder/Strobes – Models PC2RLED-LF, PC2WLED-LF, PC2RLED-B-LF, PC2WLED-B-LF intended for Ceiling Mount, indoor use.

(*) May be used with accessory models; TR-2, TR-2W, TRC-2, and TRC-2W, installed on compatible enclosure models SBBRL, SBBWL, SBBGRL, SBBGWL, SBBCRL, and SBBCWL, and used with AC adapter mounting plate models MP120KL & MP120KLA.

(**) Suitable for use on wall & ceiling.

(***) Compatible only with Listed Models PC2RL, PC2WL, P2RL, P2WL, P2WL-P, P2WL-SP, P2RL-P, P2RL-SP, CHSCRL, CHRL, CHWL, CHSCWL, CHSRL, CHSWL, HRL, HWL, HRL-LF, HWL-LF, P2RL-LF, P2WL-LF, HCRL-LF, HCWL-LF, HGRL-LF, HGWL-LF, CHSCRL, CHSCWL, PC2RL, PC2WL.

(a) Devices may be bulk-packed with System Sensor added internal control number suffix -BP10 on master shipping carton.

(b) Intended for outdoor wet use.

(c) Rated Type 4X and IP56 as standalone devices (without the backbox).

Last Updated on 2025-06-26

The appearance of a company's name or product in this database does not in itself assure that products so identified have been manufactured under UL Solutions' Follow - Up Service. Only those products bearing the UL Mark should be considered to be Certified and covered under UL Solutions' Follow - Up Service. Always look for the Mark on the product.

UL Solutions permits the reproduction of the material contained in Product iQ subject to the following conditions: 1. The Guide Information, Assemblies, Constructions, Designs, Systems, and/or Certifications (files) must be presented in their entirety and in a non-misleading manner, without any manipulation of the data (or drawings). 2. The statement "Reprinted from Product iQ with permission from UL Solutions" must appear adjacent to the extracted material. In addition, the reprinted material must include a copyright notice in the following format: "©2025 UL LLC."

Signaling Appliances and Equipment for the Hearing Impaired

COMPANY

System Sensor Unincorporated, Div of Honeywell International Inc

3825 Ohio Ave

Saint Charles, IL 60174-5467 United States

S5512

Ceiling Tile Strobe for indoor dry/damp use Model(s) SCWL(A)-TILE*

Strobe light accessories, colored lens, for private mode signaling use Model(s) LENS-A2, LENS-AC2, LENS-B2, LENS-BC2, LENS-G2, LENS-GC2, LENS-R2, LENS-RC2

Strobe lights with low frequency sounder Model(s) P2RH-LF, P2WH-LF

Strobe lights, synchronous type Model(s) SCRKLED, SCRKLED-P, SCRKLED-B, SCWKLED, SCWKLED-P, SCWKLED-B (a) (b)

Strobe lights, synchronous type Model(s) SCRL(A)*, SCWL(A)*, SCWL-CLR-ALERT*

Strobe lights, synchronous type Model(s) SGRKLED, SGRKLED-P, SGRKLED-B, SGWKLED, SGWKLED-P, SGWKLED-B (a) (b)

Strobe lights, synchronous type Model(s) SGRL(A)*, SGWL(A)*, SRL(A)*, SRL(A)-P*, SRL-SP*

Strobe lights, synchronous type Model(s) SRLED, SWLED, SRLED-B, SWLED-B, SRLED-P, SWLED-P, SRLED-SP, SWLED-SP, SWLED-CLR-ALERT, SCRLED, SCWLED, SCRLED-B, SCWLED-B, SCRLED-P, SCWLED-P, SCWLED-CLR-ALERT, SGRLED, SGWLED, SGRLED-B, SGWLED-B,

Strobe lights, synchronous type Model(s) SWL(A)*, SWL(A)-P*, SWL-ALERT*, SWL-CLR-ALERT*

Strobe lights, synchronous type, when used with the MDL Synchronization Protocol, 135, 150, 177 or 185 cd, round shape enclosure, for indoor use on wall or ceiling Model(s) SCR, SCR-P, SCR-PG, SCR-SP, SCRH, SCRH-P, SCRH-PG, SCRH-SP, SCW, SCW-CLR-ALERT, SCW-CLR-ALERT-P, SCW-CLR-ALERT-PG, SCW-CLR-ALERT-SP, SCW-P, SCW-PG, SCW-SP, SCWH, SCWH-P, SCWH-PG, SCWH-SP

Strobe lights, synchronous type, when used with the MDL Synchronization Protocol, 15, 15/75, 30, 75, 95, 110, or 115 cd, rectangular shape enclosure, for indoor use on wall or ceiling Model(s) SR, SR-P, SR-PG, SR-SP, SRH, SRH-P, SRH-PG, SRH-SP, SW, SW-CLR-ALERT, SW-CLR-ALERT-P, SW-CLR-ALERT-PG, SW-CLR-ALERT-SP, SW-P, SW-PG, SW-SP, SWH, SWH-P, SWH-PG, SWH-SP

Visual signal appliance accessories, accessory back box skirt cover Model(s) SPSEP-BBSWL

Visual signal appliance accessories, accessory retrofit trim plate Model(s) RFP+, RFPW+

Visual signal appliance accessories, accessory strobe expander plate Model(s) SEP-SPSWL, SEP-SPSWL-P

Visual signal appliance accessories, accessory trim ring Model(s) TR-HS+, TRC-HS+, TRCW-HS+, TRW-HS+

(a) - Intended for outdoor wet use

(b) - Rated Type 4X and IP56 as standalone devices (without the backbox)

* - Where A suffix Canadian models may have added suffixes -E for English, -F for French, -P for plain versions with no wording.

+ - Optional with Series SR, Series SW, Series SCR or Series SCW synchronous type strobe lights.

Last Updated on 2024-09-03

The appearance of a company's name or product in this database does not in itself assure that products so identified have been manufactured under UL Solutions' Follow - Up Service. Only those products bearing the UL Mark should be considered to be Certified and covered under UL Solutions' Follow - Up Service. Always look for the Mark on the product.

UL Solutions permits the reproduction of the material contained in Product iQ subject to the following conditions: 1. The Guide Information, Assemblies, Constructions, Designs, Systems, and/or Certifications (files) must be presented in their entirety and in a non-misleading manner, without any manipulation of the data (or drawings). 2. The statement "Reprinted from Product iQ with permission from UL Solutions" must appear adjacent to the extracted material. In addition, the reprinted material must include a copyright notice in the following format: "©2024 UL LLC."



Outdoor Selectable-Output Horns, Strobes, and Horn Strobes for Wall Applications



SpectrAlert® Advance outdoor audible visible products are rich with features that cut installation times and maximize profits.

Features

- Weatherproof per NEMA 4X, IP56
- Listed to UL 1638 (strobe) and UL 464 (horn)
- Compatible with System Sensor synchronization protocol and legacy SpectrAlert products
- Field-selectable candela settings: 15, 15/75, 30, 75, 95, 110, 115, 135, 150, 177, and 185
- Automatic selection of 12- or 24-volt operation at 15 and 15/75 candela
- Rotary switch for horn tone and three volume selections
- Horn rated at 88+ dBA at 16 volts
- Rated from -40°F to 151°F
- Universal mounting plate with an onboard shorting spring that tests wiring continuity before devices are installed
- Plug-in design with minimal intrusion into the back box
- Tamper-resistant construction
- Listed for ceiling or wall mounting

SpectrAlert Advance offers the broadest line of outdoor horns, strobes, and horn strobes in the industry. With white or red plastic housings, wall or ceiling mounting options, and plain or FIRE-printed devices, SpectrAlert Advance can meet virtually any application requirement, including indoor, outdoor, wet, and dry applications in temperatures from -40°F to 151°F.

Like the entire SpectrAlert Advance line, outdoor horns, strobes, and horn strobes for wall applications include a variety of features that increase application flexibility and simplify installation. First, field-selectable settings, including candela, automatic selection of 12- or 24-volt operation, horn tones, and three volume options enable installers to easily adapt devices to meet requirements.

Next, SpectrAlert Advance devices use a universal mounting plate for both wall and ceiling applications. This mounting plate includes an onboard shorting spring that ensures wiring continuity before devices are installed, so installers can verify proper wiring without mounting the devices and exposing them to potential construction damage. Once the plates are mounted, all SpectrAlert Advance devices utilize a plug-in design with a single captured screw to speed installation and virtually eliminate costly ground faults.

Outdoor devices ship with weatherproof plastic back boxes (metal back boxes are available separately) that accommodate in-and-out wiring for daisy chaining devices. Plastic back boxes feature removable side flanges and improved resistance to saltwater corrosion. Knock-outs located on the back eliminate the need to drill holes for screw-in mounting. Plastic and metal weatherproof back boxes come with 3/4-inch top and bottom conduit entries and 3/4-inch knock-outs at the back. A screw-in NPT plug with an O-ring gasket for a watertight seal is included with each back box.

Agency Listings



S4011 (chimes, horn strobes, horns)
S3593 (outdoor and alert strobes)



7300-1653-187 (outdoor strobes)
7125-1653-188 (horn strobes,
chime strobes)
7135-1653-189 (horns, chimes)

SpectrAlert Advance Outdoor Horn, Strobe, and Horn Strobe Specifications

Architect/Engineer Specifications

General

SpectrAlert Advance outdoor horns, strobes, and horn strobes shall mount to a weatherproof back box. A universal mounting plate shall be used for mounting ceiling and wall products. The notification appliance circuit wiring shall terminate at the universal mounting plate. Also, SpectrAlert Advance products, when used with the Sync•Circuit™ Module accessory, shall be powered from a non-coded notification appliance circuit output and shall operate on a nominal 12 or 24 volts. When used with the Sync•Circuit Module, 12-volt-rated notification appliance circuit outputs shall operate between 9 and 17.5 volts; 24-volt-rated notification appliance circuit outputs shall operate between 17 and 33 volts. Outdoor SpectrAlert Advance products shall operate between –40 and 151 degrees Fahrenheit from a regulated DC or full-wave rectified unfiltered power supply. Strobes and horn strobes shall have field-selectable candela settings including 15, 15/75, 30, 75, 95, 110, 115, 135, 150, 177, and 185.

Strobe

The strobe shall be a System Sensor SpectrAlert Advance Model _____ listed to UL 1971 and shall be approved for fire protective service. The strobe shall be wired as a primary-signaling notification appliance and comply with the Americans with Disabilities Act requirements for visible signaling appliances, flashing at 1 Hz over the strobe's entire operating voltage range. The strobe light shall consist of a xenon flash tube and associated lens/reflector system. The strobe must be installed with its weatherproof back box in order to remain outdoor approved per UL. The strobe shall be suitable for use in wet environments.

Horn Strobe Combination

The horn strobe shall be a System Sensor SpectrAlert Advance Model _____ listed to UL 1971 and UL 464 and shall be approved for fire protective service. The horn strobe shall be wired as a primary-signaling notification appliance and comply with the Americans with Disabilities Act requirements for visible signaling appliances, flashing at 1 Hz over the strobe's entire operating voltage range. The strobe light shall consist of a xenon flash tube and associated lens/reflector system. The horn shall have three audibility options and an option to switch between a temporal three pattern and a non-temporal (continuous) pattern. These options shall be set by a multiple position switch. On four-wire products, the strobe shall be powered independently of the sounder. The horn or horn strobe models shall operate on a coded or non-coded power supply. The horn strobe must be installed with its weatherproof back box in order to remain outdoor approved per UL. The horn strobe shall be suitable for use in wet environments.

Physical/Electrical Specifications

Operating Temperature	–40°F to 151°F (–40°C to 66°C)
Strobe Flash Rate	1 flash per second
Nominal Voltage	Regulated 12 DC/FWR or regulated 24 DC/FWR ¹
Operating Voltage Range²	8 to 17.5 V (12 V nominal) or 16 to 33 V (24 V nominal)
Input Terminal Wire Gauge	12 to 18 AWG
Wall-Mount Dimensions (including lens)	5.6" L × 4.7" W × 2.5" D (142 mm L × 119 mm W × 64 mm D)
Horn Dimensions	5.6" L × 4.7" W × 1.3" D (142 mm L × 119 mm W × 33 mm D)
Wall-Mount Weatherproof Back Box Dimensions (SA-WBB)	5.7" L × 5.1" W × 2.0" D (145 mm L × 130 mm W × 51 mm D)

Notes:

1. Full Wave Rectified (FWR) voltage is a non-regulated, time-varying power source that is used on some power supply and panel outputs.
2. P, S, PC, and SC products will operate at 12 V nominal only for 15 and 15/75 cd.

UL Current Draw Data

UL Max. Strobe Current Draw (mA RMS)						UL Max. Horn Current Draw (mA RMS)					
	Candela	8–17.5 Volts		16–33 Volts		Sound Pattern	dB	8–17.5 Volts		16–33 Volts	
		DC	FWR	DC	FWR			DC	FWR	DC	FWR
Standard Candela Range	15	123	128	66	71	Temporal	High	57	55	69	75
	15/75	142	148	77	81	Temporal	Medium	44	49	58	69
	30	NA	NA	94	96	Temporal	Low	38	44	44	48
	75	NA	NA	158	153	Non-Temporal	High	57	56	69	75
	95	NA	NA	181	176	Non-Temporal	Medium	42	50	60	69
	110	NA	NA	202	195	Non-Temporal	Low	41	44	50	50
	115	NA	NA	210	205	Coded	High	57	55	69	75
High Candela Range	135	NA	NA	228	207	Coded	Medium	44	51	56	69
	150	NA	NA	246	220	Coded	Low	40	46	52	50
	177	NA	NA	281	251						
	185	NA	NA	286	258						

UL Max. Current Draw (mA RMS), 2-Wire Horn Strobe, Standard Candela Range (15–115 cd)									
DC Input	8–17.5 Volts			16–33 Volts					
	15	15/75	15	15/75	30	75	95	110	115
Temporal High	137	147	79	90	107	176	194	212	218
Temporal Medium	132	144	69	80	97	157	182	201	210
Temporal Low	132	143	66	77	93	154	179	198	207
Non-Temporal High	141	152	91	100	116	176	201	221	229
Non-Temporal Medium	133	145	75	85	102	163	187	207	216
Non-Temporal Low	131	144	68	79	96	156	182	201	210
FWR Input									
Temporal High	136	155	88	97	112	168	190	210	218
Temporal Medium	129	152	78	88	103	160	184	202	206
Temporal Low	129	151	76	86	101	160	184	194	201
Non-Temporal High	142	161	103	112	126	181	203	221	229
Non-Temporal Medium	134	155	85	95	110	166	189	208	216
Non-Temporal Low	132	154	80	90	105	161	184	202	211

UL Max. Current Draw (mA RMS), 2-Wire Horn Strobe, High Candela Range (135–185 cd)									
DC Input	16–33 Volts				FWR Input	16–33 Volts			
	135	150	177	185		135	150	177	185
Temporal High	245	259	290	297	Temporal High	215	231	258	265
Temporal Medium	235	253	288	297	Temporal Medium	209	224	250	258
Temporal Low	232	251	282	292	Temporal Low	207	221	248	256
Non-Temporal High	255	270	303	309	Non-Temporal High	233	248	275	281
Non-Temporal Medium	242	259	293	299	Non-Temporal Medium	219	232	262	267
Non-Temporal Low	238	254	291	295	Non-Temporal Low	214	229	256	262

Candela Derating

For K series products used at low temperatures, listed candela ratings must be reduced in accordance with this table.

Strobe Output (cd)	
Listed Candela	Candela rating at –40°F
15	Do not use below 32°F
15/75	
30	
75	
95	44
110	70
115	110
135	135
150	150
177	177
185	185

Horn Tones and Sound Output Data

Horn and Horn Strobe Output (dBA)											
Switch Position	Sound Pattern	dB	8–17.5 Volts		16–33 Volts		24-Volt Nominal				
			DC	FWR	DC	FWR	Reverberant		Anechoic		
			DC	FWR	DC	FWR	DC	FWR	DC	FWR	
1	Temporal	High	78	78	84	84	88	88	99	98	
2	Temporal	Medium	74	74	80	80	86	86	96	96	
3	Temporal	Low	71	73	76	76	83	80	94	89	
4	Non-Temporal	High	82	82	88	88	93	92	100	100	
5	Non-Temporal	Medium	78	78	85	85	90	90	98	98	
6	Non-Temporal	Low	75	75	81	81	88	84	96	92	
7†	Coded	High	82	82	88	88	93	92	101	101	
8†	Coded	Medium	78	78	85	85	90	90	97	98	
9†	Coded	Low	75	75	81	81	88	85	96	92	

†Settings 7, 8, and 9 are not available on 2-wire horn strobe.

SpectrAlert Advance Diagrams

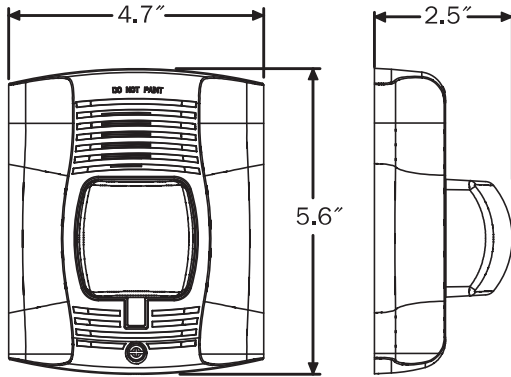

Wall-Mount Horn Strobes

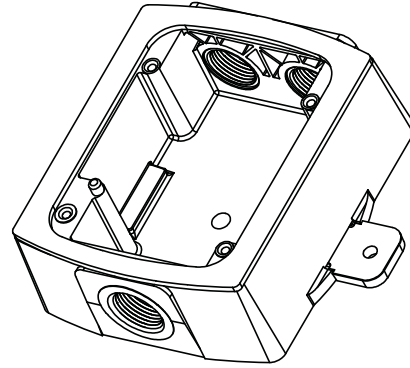

Wall Plastic Weatherproof Back Box

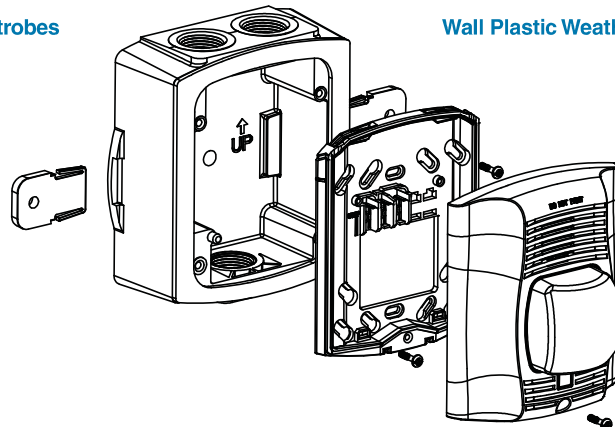

Wall-Mount Horn Strobe with Plastic Weatherproof Back Box

SpectrAlert Advance Ordering Information

Model	Description
Wall Horn Strobes	
P2RK*†	2-Wire Horn Strobe, Standard cd, Red, Outdoor (includes plastic weatherproof back box)
P2RHK*†	2-Wire Horn Strobe, High cd, Red, Outdoor (includes plastic weatherproof back box)
P2WK*†	2-Wire Horn Strobe, Standard cd, White, Outdoor (includes plastic weatherproof back box)
P2WHK*†	2-Wire Horn Strobe, High cd, White, Outdoor (includes plastic weatherproof back box)
P4RK†	4-Wire Horn Strobe, Standard cd, Red, Outdoor (includes plastic weatherproof back box)
P4WK	4-Wire Horn Strobe, Standard cd, White, Outdoor (includes plastic weatherproof back box)
P2RHK-120	2-Wire Horn Strobe, High cd, Red, Outdoor, 120 V (includes plastic weatherproof back box)
Wall Strobes	
SRK*†	Strobe, Standard cd, Red, Outdoor (includes plastic weatherproof back box)
SRHK*†	Strobe, High cd, Red, Outdoor (includes plastic weatherproof back box)
SWK*†	Strobe, Standard cd, White, Outdoor (includes plastic weatherproof back box)
SWHK*†	Strobe, High cd, White, Outdoor (includes plastic weatherproof back box)
Horns	
HRK†	Horn, Red, Outdoor (includes plastic weatherproof back box)
Accessories	
SA-WBB	Red, Metal Weatherproof Back Box
SA-WBBW	White, Metal Weatherproof Back Box

Notes:

* Add "-P" to model number for plain housing (no "FIRE" marking on cover), e.g., P2RK-P.

† Add "-R" to model number for weatherproof replacement device (no back box included), only for use with weatherproof outdoor flush mounting plate, WTP and WTPW. "Standard cd" refers to strobes that include 15, 15/75, 30, 75, 95, 110, and 115 candela settings. "High cd" refers to strobes that include 135, 150, 177, and 185 candela settings. **When replacing standard outdoor units both the device and back box must be replaced.**



3825 Ohio Avenue • St. Charles, IL 60174
Phone: 800-SENSOR2 • Fax: 630-377-6495

©2012 System Sensor.
Product specifications subject to change without notice. Visit systemsensor.com
for current product information, including the latest version of this data sheet.
AVDS01201 • 3/12



ULSZ.S4011 Audible-signal Appliances

[Page Bottom](#)

Audible-signal Appliances

[See General Information for Audible-signal Appliances](#)

SYSTEM SENSOR UNINCORPORATED, DIV OF HONEYWELL INTERNATIONAL INC

S4011

3825 Ohio Ave
Saint Charles, IL 60174-5467 USA

Bells, vibrating, Models SSM24-6, SSM24-8, SSM24-10, SSV120-6, SSV120-8, SSV120-10 for outdoor use when used with NEMA 3R weather resistant back box, Model WBB.

Chimes, Model CH12/24 for indoor use private mode only; Model WBB for outdoor use.

Models CHR, CHW, CHRA, CHWA. For indoor use, private mode use only.

Chimes/strobes, Models CH24MC, CH24MCW. For wall mount, indoor use.

Models CHSR, CHSW. For indoor use only, private mode use only.

Horns, Model PA400W with or without suffix -F. For indoor use only.

Models HR, HW. Intended for indoor use mounted on the wall or ceiling.

Models MHR, MHW. For indoor use only.

Tones 1, 2, 3 and 4 are Public Mode at 24V DC/FWR.

Tone 3 is Public Mode at 12V DC.

Tones 1, 2 and 4 are Private Mode at 12V DC.

Tones 1, 2, 3 and 4 are Private Mode at 12V FWR.

Model APA151. For indoor use only. Public mode.

Mini-Horn, Model MHR1, Input: 8 - 33 Vdc, 8 - 33 Vfwr; for indoor use only.

Sounder/strobes, Model P2475RL . May employ "W" or "Z" suffix. For indoor wall mount only.

Model P12015K for indoor or outdoor use.

Directional sounders, Model PF24V for supplemental fire alarm use. Indoor use only.

520 Hz Low frequency sounders, Models HR-LF, HW-LF. Intended for indoor use only and may be mounted on the wall or the ceiling.

520 Hz Low frequency sounders/strobes, Models P2RH-LF, P2WH-LF. Intended for indoor use only and may be mounted on the wall or the ceiling.

SPECTRALERT ADVANCE SERIES HORNS, CHIMES AND COMBOS

General - Models with "K" in the suffix are suitable for indoor or outdoor use with an operating temperature rating of -40°C to +66°C (-40°F to +151°F) and have a NEMA Type 3, 3R and 4X enclosure ratings only when used with the Listed Plastic models SA-WBB and SA-WBBW (wall) or the Plastic models SA-WBBC and SA-WBBCW (ceiling) weatherproof back boxes. Models with "-P" in the suffix have plain housings with no lettering on the enclosure. Models not containing either "-P", in the suffix have English lettering reading "FIRE" on the housing. Models with the "-SP" suffix have Spanish lettering reading "FUEGO" on the housing. Models with the "-PG" suffix have Portuguese lettering reading "FOGO" on the housing.

Horns - Models HR, HW. Intended for indoor use mounted on the wall or ceiling.

Horns - Model HRK. Intended for indoor or outdoor use mounted on the wall or ceiling.

Chimes - Models CHR, CHW are intended for private mode only. Intended for indoor use mounted on the wall or ceiling.

Chime/Strobes - Models CHSR, CHSW are intended for private mode only. Intended for indoor use mounted on the wall or ceiling.

Horn/Strobes - Two-wire type, rectangular enclosure, Models P2R, P2W, P2RH, P2WH. Intended for indoor use mounted on the wall or ceiling.

Horn/Strobes - Two-wire type, rectangular enclosure, Models P2RK, P2WK, P2RHK, P2WHK, P2RK-P, P2RHK-P, P2WK-P, P2WHK-P. Intended for indoor use mounted on the wall or ceiling.

Horn/Strobes - Two-wire type, round enclosure, Models PC2R, PC2W, PC2RH, PC2WH. Intended for indoor use mounted on the wall or ceiling.

Horn/Strobes - Two-wire type, round enclosure, Models PC2RK, PC2WK, PC2RHK, PC2WHK. Intended for indoor use mounted on the wall or ceiling.

Horn/Strobes - Four-wire type, rectangular enclosure, Models P4R, P4W, P4RH, P4WH. Intended for indoor use mounted on the wall or ceiling.

Horn/Strobes - Four-wire type, round enclosure, Models PC4R, PC4W, PC4RH, PC4WH. Intended for indoor use mounted on the wall or ceiling.

GLOBAL AV COMBO PRODUCT SERIES HORNS, STROBES AND COMBOS:

General - Models for indoor wall and ceiling mount only and for use with an operating temperature of 0°C to +49°C (32°F to +120°F). Models with "R" in the suffix implement a red strobe lens.

Horn/Strobes - Two-wire type, rectangular enclosure, Models SYS-HS, SYS-HSR, SYS-HSR-FIRE, SYS-HSW, SYS-HSRW, SYS-HSRW-FIRE. Intended for indoor use mounted on the wall or ceiling.

Accessories:

Back box, Model WBBF for indoor/outdoor use.

Models SA-WBB, SA-WBBC (Back boxes for Spectralert Advance Series) for indoor/outdoor use.

Back box skirts, Models BBSC, BBSCW, BBS-CHSW, BBS-CHSR.

Flush mount trim plates, Models MPF2, -2B.

Weatherproof plates, Models WTP, WTPW, WTP-SP, WTP-SPW, with a NEMA Type 3R and IP22 enclosure ratings. May be used in place of the listed weatherproof back boxes as follows:

Models WTP (Red), WTPW (White) Weatherproof Plates used with horn and horn/strobes models with "K" suffix, suitable for indoor or outdoor flush mount usage, wall or ceiling, with an extended operating temperature range of -40 degrees F to 151 degrees F (-40 degrees C to 66 degrees C). They can be mounted to 2 inch by 4 inch or 4 inch by 4 inch back boxes, with a 1-1/2 inch minimum depth.

Models WTP-SP (Red), WTP-SPW (White) Weatherproof Plates used with speakers and speaker/strobes models with "K" suffix, suitable for indoor or outdoor use flush mount usage, wall or ceiling, with an operating temperature rating of -40 degrees F to 151 degrees F (-40 degrees C to 66 degrees C). They can only be mounted to a 4 inch by 4 inch by 2-1/8 inch back box.

Semi-flush mount trim plates, Models D-MP, S-MP. May employ "W" suffix.

Sync modules, Models MDL3R, MDL3W, MDL, MDLW.

Models MDL3R, MDL3W are also Listed under Audible-signal Appliances (ULSZ).

120 VAC adapter mounting plate, Model MP120K may be used with Models P2R, P2RH, P2RK, P2RHK, P2W, P2WH, SR, SRH, SRK, SRHK, SW, SWH, PC2R, PC2RH, PC2RK, PC2RHK, PC2W, PC2WH, SCR, SCRH, SCRK, SCRHK, SCW, SCWH, HR, HRK, HW, SR-P, SW-P, SRH-P, SWH-P, P2R-P, P2W-P, P2RH-P, P2WH-P, SCR-P, SCW-P, SCRH-P, SCWH-P, PC2R-P, PC2W-P, PC2RH-P, PC2WH-P, SR-SP, SRH-SP, P2R-SP, P2RH-SP, SCW-SP, SCWH-SP, PC2W-SP, PC2WH-SP, CHR, CHW, CHSR, CHSW.

Smoke detector audible bases, Models B501BH, B501BHT, B501BH-2, B501BHT-2.

Audible signal appliance accessories, accessory retrofit trim plates, Models RFP, RFPW. Optional with Series H horns, Series CH Chimes, Series CHS Chime/Strobes, Series P2 Horn/Strobes, Series PC2 Horn/Strobes, Series P4 Horn/Strobes, and Series PC4 Horn/Strobes.

Audible signal appliance accessories, accessory trim rings, Models TR-HS, TRW-HS, TRC-HS, TRCW-HS. Optional with Series H horns, Series CH Chimes, Series CHS Chime/Strobes, Series P2 Horn/Strobes, Series PC2 Horn/Strobes, Series P4 Horn/Strobes, and Series PC4 Horn/Strobes.

Ceiling trim ring, Optional with Models SYS-HS, SYS-HSR, SYS-HSR-FIRE, SYS-ST, SYS-STR.

Ceiling trim plates, Models SYS-CTP, SYS-CTPR, SYS-CTPR-FIRE, SYS-CTPW, SYS-CTPRW, SYS-CTPRW-FIRE.

Last Updated on 2015-02-25

[Questions?](#)

[Print this page](#)

[Terms of Use](#)

[Page Top](#)

© 2015 UL LLC

When the UL Leaf Mark is on the product, or when the word "Environment" is included in the UL Mark, please search the [UL Environment database](#) for additional information regarding this product's certification.

The appearance of a company's name or product in this database does not in itself assure that products so identified have been manufactured under UL's Follow-Up Service. Only those products bearing the UL Mark should be considered to be Certified and covered under UL's Follow-Up Service. Always look for the Mark on the product.

UL permits the reproduction of the material contained in the Online Certification Directory subject to the following conditions: 1. The Guide Information, Assemblies, Constructions, Designs, Systems, and/or Certifications (files) must be presented in their entirety and in a non-misleading manner, without any manipulation of the data (or drawings). 2. The statement "Reprinted from the Online Certifications Directory with permission from UL" must appear adjacent to the extracted material. In addition, the reprinted material must include a copyright notice in the following format: "© 2015 UL LLC".

BAT Series Batteries

Sealed Lead-Acid or Gell Cell



Power Supplies

General

BAT Series Batteries feature a new part-numbering/listing system — providing an improved method of delivery for NOTIFIER-approved sealed lead-acid batteries for all your fire alarm system needs. Multiple brands of batteries are now offered under generic part numbers, reducing backorder situations and permitting us to deliver these products in a more timely fashion. NOTIFIER has approved the multiple brands listed below as possible product shipped for a given part number. Please note that any incoming orders for “PS Series” batteries will be converted to the equivalent BAT Series part numbers.



6933cov.jpg

Features

- Provide secondary power for control panels.
- Sealed and maintenance-free.
- Overcharge protected.
- Easy handling with leakproof construction.
- Ruggedly constructed, high-impact case (ABS, polystyrene, or polypropylene, depending on models).
- Long service life.
- Compact design.

Agency Listings and Approvals

The listings and approvals below apply to BAT Series Batteries. In some cases, certain modules may not be listed by certain approval agencies, or listing may be in process. Consult factory for latest listing status.

- **UL Recognized Components:** files MH19884 (*B & B Battery*), MH20567 (*UPG, previously Jolt*), MH20845 (*Power-Sonic*).

Part Number Reference

CURRENT Part Number	BATTERY DESCRIPTION	ALTERNATES APPROVED: manufacturers and P/Ns shipped under BAT P/Ns
BAT-1250	12 V, 5 AH, sealed.	BP5-12 (B&B Battery); PS-1250 (Power-Sonic); SA1250 (Jolt) to be replaced with UB1250 (UPG).
BAT-1250	12 V, 5 AH, sealed.	BP5-12 (B&B Battery); PS-1250 (Power-Sonic); SA1250 (Jolt) to be replaced with UB1250 (UPG).
BAT-1270	12 V, 7 AH, sealed.	BP7-12 (B&B Battery); PS-1270 (Power-Sonic); SA1272 (Jolt) to be replaced with UB1270 (UPG).
BAT-12120	12 V, 12 AH, sealed.	BP12-12 (B&B Battery); PS-12120 (Power-Sonic); SA12120 (Jolt) to be replaced with UB12120 (UPG).
BAT-12180	12 V, 18 AH, sealed.	PS-12180 (Power-Sonic); SA12180 (Jolt) to be replaced with UB12180 (UPG).
BAT-12180	12 V, 18 AH, sealed.	PS-12180 (Power-Sonic); SA12180 (Jolt) to be replaced with UB12180 (UPG).
BAT-12260	12 V, 26 AH, sealed.	BP26-12 (B&B Battery); PS-12260 (Power-Sonic); SA12260 (Jolt) to be replaced with UB12260 (UPG).
BAT-12550	12 V, 55 AH, sealed.	PS-12550 (Power-Sonic); XSA12550 (Jolt) to be replaced with UB12550 (UPG).
BAT-12550	12 V, 55 AH, sealed.	PS-12550 (Power-Sonic); XSA12550 (Jolt) to be replaced with UB12550 (UPG).
BAT-121000	12 V, 100 AH, gell cell.	PS-121000 (Power-Sonic); XSA121000A (Jolt) to be replaced with UB121000 (UPG).

POWER-SONIC

Part Number Reference

1109t1.tbl

MODEL	Nominal Voltage V	Nominal Capacity @ 20 hr. rate A.H.	Discharge Current @20 hr. rate mA	DIMENSIONS									
				Width		Depth		Height		Height over terminal		Weight	
				in.	mm	in.	mm	in.	mm	in.	mm	lb.	kg.
PS-1250	12	5	250	3.54	90	2.76	70	4.02	102	4.21	107	4.1	1.9
PS-1270	12	7	325	5.94	151	2.56	65	3.7	94	3.86	98	5.7	2.6
PS-12120	12	12	600	5.94	151	3.86	98	3.7	94	3.86	98	8.8	4
PS-12180	12	18	875	7.13	181	2.99	76	6.57	167	6.57	167	12.8	5.8
PS-12250	12	25	1300	6.89	175	6.54	166	4.92	125	4.92	125	18.7	8.5
PS-12550	12	55	3000	10.25	260	6.6	168	8.2	208	9.45	240	39.7	18
PS-121000	12	100	5000	12	305	6.6	168	8.2	208	9.45	240	65.7	29.8

Characteristic Discharge Curves

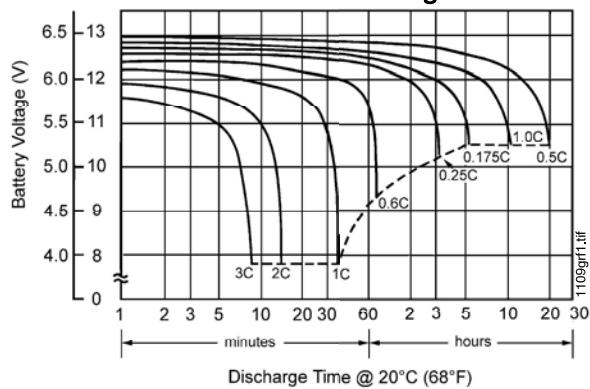

Effect of Temperature on Capacity

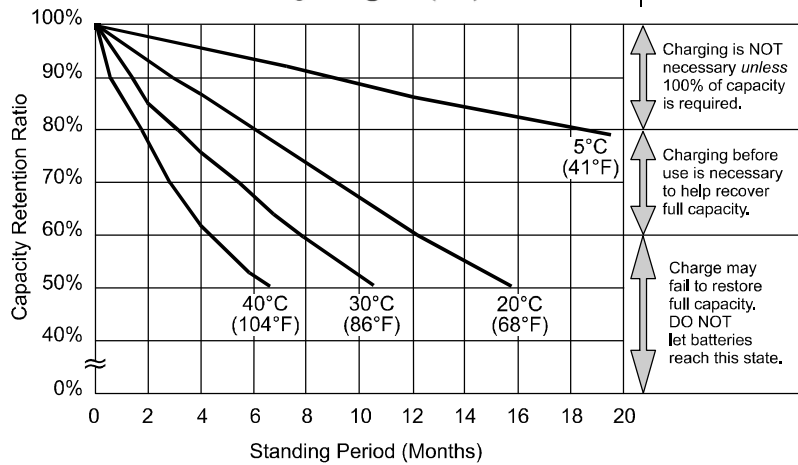
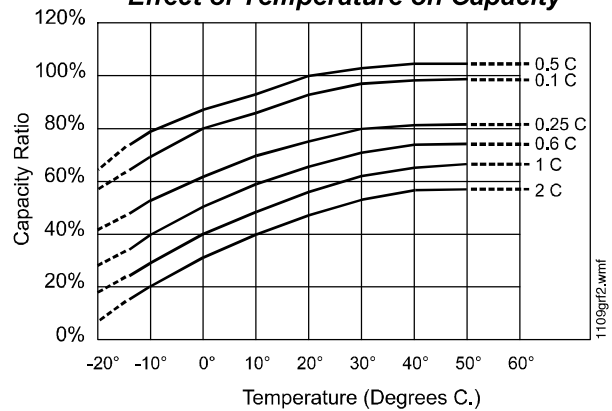

**at left:
PS-121000
Shelf-Life
and Storage**

Charging is NOT necessary unless 100% of capacity is required.
Charging before use is necessary to help recover full capacity.
Charge may fail to restore full capacity. DO NOT let batteries reach this state.

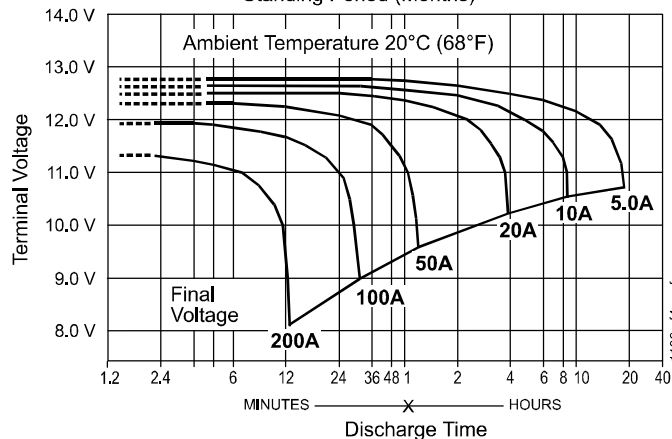

**at left:
PS-121000
Discharge
Characteristics**

B & B BATTERY

Model	V	Nominal Capacity (AH)				Weight		Terminal				Dimensions							
								Standard		Optional		L		W		H		TH	
		20 hr	10 hr	5 hr	1 hr	kg	lbs	Type	Pos.	Type	Pos.	mm	in	mm	in	mm	in	mm	in
BP5-12	12	5.00	4.75	4.25	3.00	1.86	4.10	T1	3	T2		90	3.54	70	2.76	102	4.02	106	4.17
BP7-12	12	7.00	6.65	5.95	4.20	2.60	5.73	T2	5	T1		151	5.94	65	2.56	93	3.66	98	3.86
BP12-12	12	12.00	11.40	10.20	7.20	4.03	8.89	B1	5	T1		151	5.94	98	3.86	94	3.70	98	3.86
BP26-12	12	26.00	24.70	22.10	15.60	9.40	20.73	B1	7	T2.11	9	175	6.89	166	6.54	125	4.92	125	4.92

Charging Procedure

Application	Charging method	Charging voltage at 20°C (V/cell)	Temperature compensation coefficient of charging voltage (mV/°C/cell)	Maximum charging current (CA)	Charging time 0.1 CA, 20°C (h)		Temp (°C)
					100% discharge	50% discharge	
For standby power source	Constant voltage and constant current charging (with current restriction)	2.25 ~ 2.30	- 3	0.3	24	20	0 - 40°C (32 ~ 104°F)
For cycle service		2.40 ~ 2.50	- 4	0.3	16	10	

Temperature compensation of charging voltage is not needed when using the batteries within 5°C to 35°C range.

Final Voltage	Discharge Time: for Model BP5-12								
	5 min	10 min	15 min	30 min	1 hr	3 hr	5 hr	10 hr	20 hr
	Battery Output Power (W): for Model BP5-12								
10.80 V	180.8	133.1	106.6	63.5	36.39	14.57	10.05	5.62	2.94
10.50 V	209.2	144.2	111.5	65.9	37.48	14.87	10.20	5.70	3.00
10.20 V	222.3	149.4	115.0	67.4	38.16	15.00	10.26	5.73	3.01
9.90 V	232.3	152.9	117.6	68.3	38.61	15.10	10.29	5.75	3.02
9.60 V	240.0	156.0	120.0	69.0	39.0	15.20	10.32	5.75	3.02

Constant Power Discharge Characteristics at 25°C/77°F for BP5-12

Final Voltage	Discharge Time: for Model BP7-12								
	5 min	10 min	15 min	30 min	1 hr	3 hr	5 hr	10 hr	20 hr
	Battery Output Power (W): for Model BP7-12								
10.80 V	253.1	186.3	149.3	88.8	50.95	20.40	14.07	7.86	4.11
10.50 V	292.9	201.8	156.2	92.2	52.47	20.81	14.28	7.98	4.20
10.20 V	311.2	209.1	161.0	94.3	53.42	21.00	14.36	8.02	4.22
9.90 V	325.2	214.1	164.7	95.6	54.06	21.15	14.41	8.04	4.23
9.60 V	336.0	218.4	168.0	96.6	54.60	21.27	14.45	8.04	4.23

Constant Power Discharge Characteristics at 25°C/77°F for BP7-12

Final Voltage	Discharge Time: for Model BP12-12								
	5 min	10 min	15 min	30 min	1 hr	3 hr	5 hr	10 hr	20 hr
	Battery Output Power (W): for Model BP12-12								
10.80 V	433.9	319.4	256.0	152.3	87.34	34.98	24.12	13.48	7.05
10.50 V	502.2	346.0	267.7	158.1	89.96	35.68	24.48	13.68	7.20
10.20 V	533.6	358.5	276.0	161.7	91.57	36.00	24.61	13.75	7.23
9.90 V	557.5	367.1	282.4	164.0	92.67	36.25	24.70	13.79	7.25
9.60 V	576.0	374.4	288.0	165.6	93.60	36.47	24.77	13.79	7.25

Constant Power Discharge Characteristics at 25°C/77°F for BP12-12

Final Voltage	Discharge Time: for Model BP26-12								
	5 min	10 min	15 min	30 min	1 hr	3 hr	5 hr	10 hr	20 hr
	Battery Output Power (W): for Model BP26-12								
10.80 V	940.0	692.0	554.6	330.0	189.23	75.79	52.25	29.20	15.26
10.50 V	1088.0	749.7	580.0	342.5	194.91	77.30	53.04	29.64	15.60
10.20 V	1156.0	776.7	598.0	350.3	198.41	78.00	53.33	29.79	15.67
9.90 V	1208.0	795.3	611.8	355.2	200.79	78.54	53.52	29.88	15.71
9.60 V	1248.0	811.2	624.0	358.8	202.80	79.01	53.68	29.88	15.71

Constant Power Discharge Characteristics at 25°C/77°F for BP26-12

B & B BATTERY

BP5-12 Battery Discharge Characteristics (25°C/77°F)

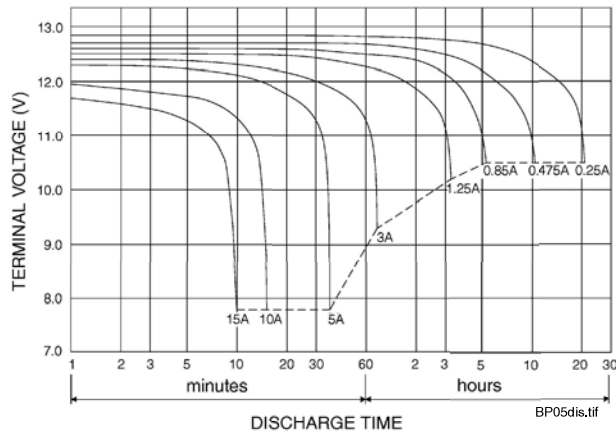

BP7-12 Battery Discharge Characteristics (25°C/77°F)

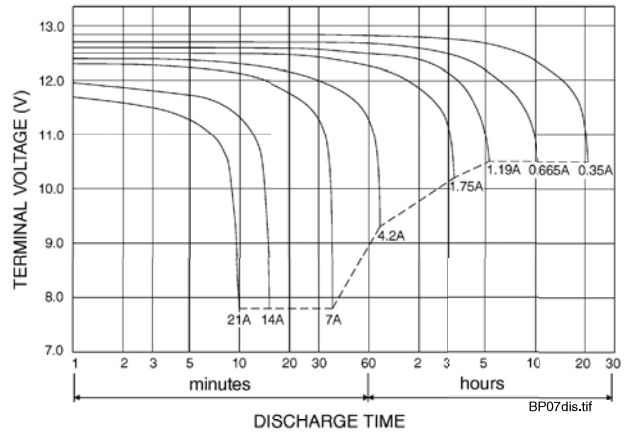

BP12-12 Battery Discharge Characteristics (25°C/77°F)

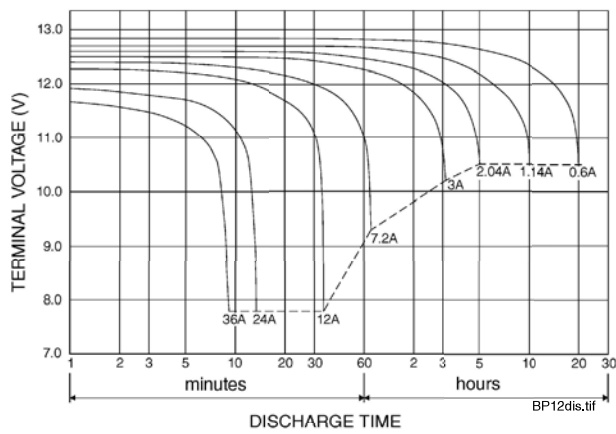

BP26-12 Battery Discharge Characteristics (25°C/77°F)

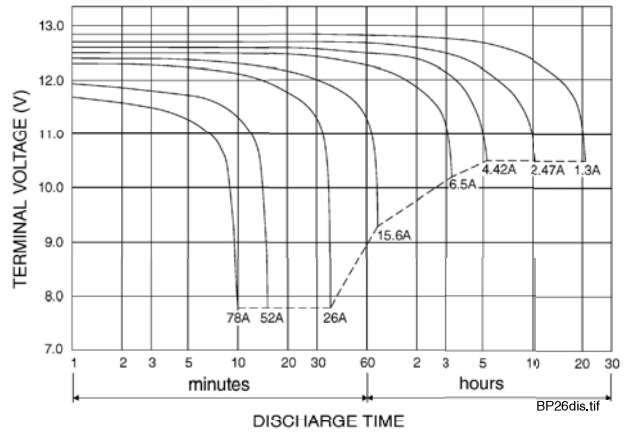

BP05-12



BP12-12



BP26-12



UPG BATTERY

UB1250 has the same specifications as previous Jolt SA1250; SA1272 to be replaced with UB1270 (specs/diagrams pending).

UB1250 (previously SA1250) Diagrams

UB1250/SA1250 discharge current vs. time

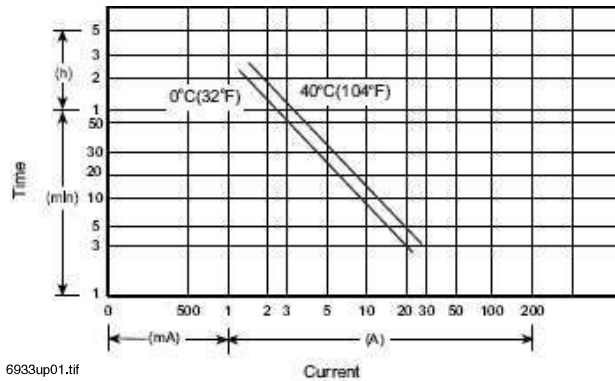

6933up01.tif

UB1250/SA1250 discharge characteristics (25°C/77°F)

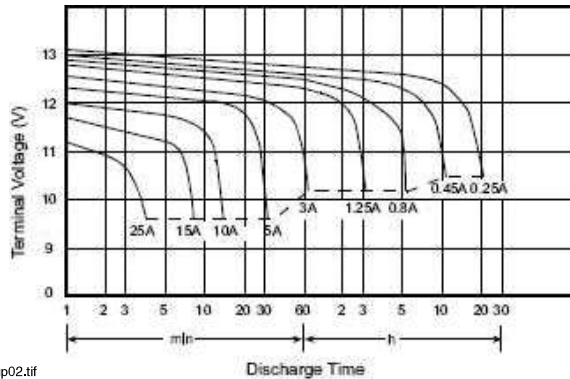

6933up02.tif

UB1250, SA1250 Specifications

- Nominal voltage: 12 V.
- Nominal capacity (20 hr): 5.0 AH.
- Dimensions: total height 107 mm (4.21"); container height 101 mm (3.98"); length 90 mm (3.54"); width 70 mm (2.76").
- Weight: approximately 1.83 kg (4.03 lbs).
- Container material: UL94HB ABS, UL94V-0 ABS.
- Internal resistance (25°C, 77°F): ~ 32 m.
- Discharge capacity under different temperatures:
 - 40°C: ~ 102%
 - 25°C: ~ 100%
 - 0°C: ~ 85%
- Capacity 25°C/77°F:
 - 20 hr @ 0.25 A: 5.0 AH.
 - 5 hr @ 0.8 A: 4.0 AH.
 - 1 hr @ 3.0 A: 3.0 AH.
 - 1 C @ 5.0 A: 2.5 AH.
- Charging voltage (25°C, 77°F):
 - Standby use: 13.65 V ± 0.15 V.
 - Cycle use: 14.7 V ± 0.3 V.
- Maximum discharge current: 60 A (5 sec).
- Maximum charging current: 1.5 A.
- Self-discharge residual capacity (25°C, 77°F):
 - After 3 months: ~ 90%.
 - After 6 months: ~ 82%.
 - After 12 months: ~ 70%.

SA1272 Diagrams

SA1272 discharge current vs. time

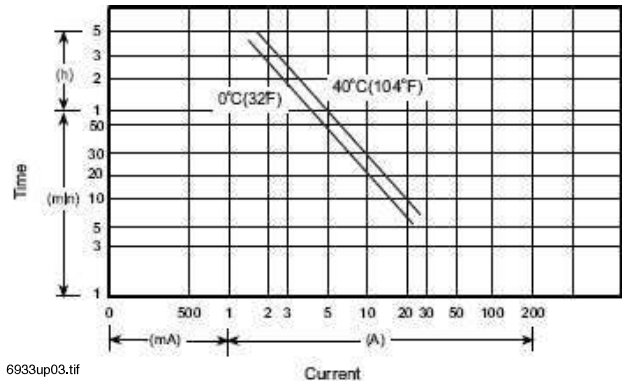

6933up03.tif

SA1272 discharge characteristics (25°C/77°F)

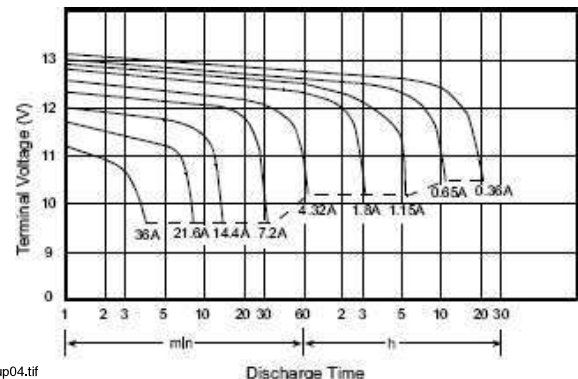

6933up04.tif

SA1272 Specifications

- Nominal voltage: 12 V.
- Nominal capacity (20 hr): 7.2 AH.
- Dimensions: total height 100 mm (3.94"); container height 94 mm (3.70"); length 151 mm (5.95"); width 65 mm (2.56").
- Weight: approximately 2.66 kg (5.85 lbs).
- Container material: UL94HB ABS, UL94V-0 ABS.
- Internal resistance (25°C, 77°F): ~ 22 m.
- Discharge capacity under different temperatures:
 - 40°C: ~ 102%
 - 25°C: ~ 100%
 - 0°C: ~ 85%
- Capacity 25°C/77°F:
 - 20 hr @ 0.36 A: 7.2 AH.
 - 5 hr @ 1.15 A: 5.76 AH.
 - 1 hr @ 4.32 A: 4.32 AH.
 - 1 C @ 7.2 A: 3.6 AH.
- Charging voltage (25°C, 77°F):
 - Standby use: 13.65 V ± 0.15 V.
 - Cycle use: 14.7 V ± 0.3 V.
- Maximum discharge current: 90 A (5 sec).
- Maximum charging current: 2.16 A.
- Self-discharge residual capacity (25°C, 77°F):
 - After 3 months: ~ 90%.
 - After 6 months: ~ 82%.
 - After 12 months: ~ 70%.

UPG BATTERY

Same specifications as previous Jolt models; packaging and part numbers are the only changes.

UB12120 (was SA12120) Diagrams

UB12120/SA12120 discharge current vs. time

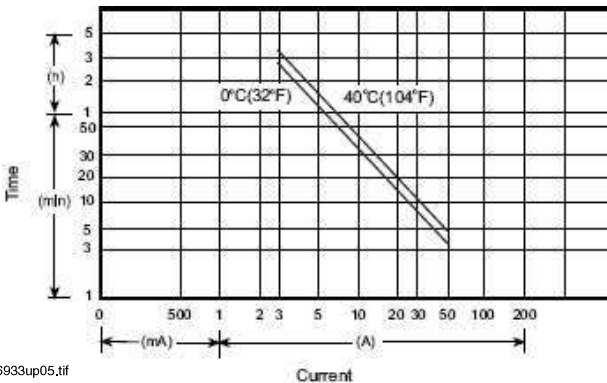

6933up05.tif

UB12120/SA12120 discharge characteristics (25°C/77°F)

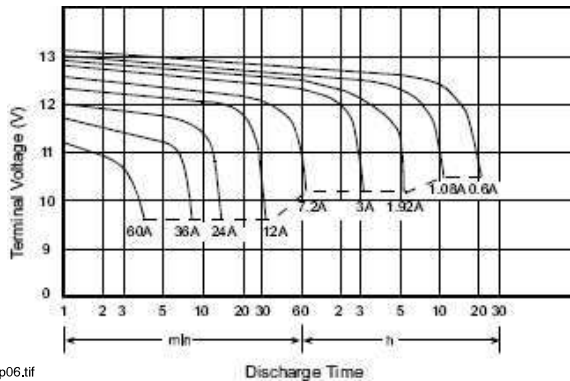

6933up06.tif

UB12120, SA12120 Specifications

- Nominal voltage: 12 V.
 - Nominal capacity (20 hr): 12.0 AH.
 - Dimensions: total height 100 mm (3.94"); container height 94 mm (3.70"); length 151 mm (5.95"); width 98 mm (3.86").
 - Weight: approximately 4.10 kg (9.04 lbs).
 - Container material: UL94HB ABS, UL94V-0 ABS.
 - Internal resistance (25°C, 77°F): ~ 14 m.
 - Discharge capacity under different temperatures:
 - 40°C: ~ 102%
 - 25°C: ~ 100%
 - 0°C: ~ 85%
 - Capacity 25°C/77°F:
 - 20 hr @ 0.6 A: 12.0 AH.
 - 5 hr @ 1.92 A: 9.6 AH.
 - 1 hr @ 7.2 A: 7.2 AH.
 - 1 C @ 12.0 A: 6.0 AH.
 - Charging voltage (25°C, 77°F):
 - Standby use: 13.65 V ± 0.15 V.
 - Cycle use: 14.7 V ± 0.3 V.
- Maximum discharge current: 120 A (5 sec).
 Maximum charging current: 3.6 A.
 Self-discharge residual capacity (25°C, 77°F):
- After 3 months: ~ 90%.
 - After 6 months: ~ 82%.
 - After 12 months: ~ 70%.

UB12180 (was SA12180) Diagrams

UB12180/SA12180 discharge current vs. time

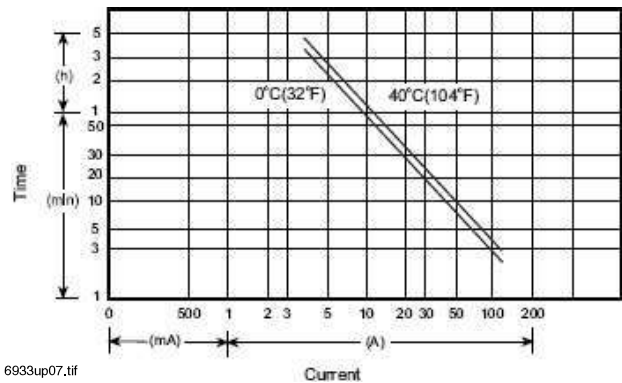

6933up07.tif

UB12180/SA12180 discharge characteristics (25°C/77°F)

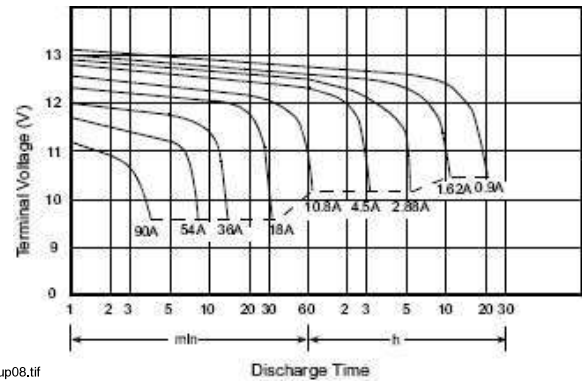

6933up08.tif

UB12180, SA12180 Specifications

- Nominal voltage: 12 V.
 - Nominal capacity (20 hr): 18.0 AH.
 - Dimensions: total height 167 mm (6.58"); container height 167 mm (6.58"); length 181 mm (7.13"); width 76 mm (2.29").
 - Weight: approximately 6.06 kg (13.36 lbs).
 - Container material: UL94HB ABS, UL94V-0 ABS.
 - Internal resistance (25°C, 77°F): ~ 13 m.
 - Discharge capacity under different temperatures:
 - 40°C: ~ 102%
 - 25°C: ~ 100%
 - 0°C: ~ 85%
 - Capacity 25°C/77°F:
 - 20 hr @ 0.9 A: 18.0 AH.
 - 5 hr @ 2.88 A: 14.4 AH.
 - 1 hr @ 10.8 A: 10.8 AH.
 - 1 C @ 18.0 A: 9.0 AH.
 - Charging voltage (25°C, 77°F):
 - Standby use: 13.65 V ± 0.15 V.
 - Cycle use: 14.7 V ± 0.3 V.
- Maximum discharge current: 300 A (5 sec).
 Maximum charging current: 5.4 A.
 Self-discharge residual capacity (25°C, 77°F):
- After 3 months: ~ 90%.
 - After 6 months: ~ 82%.
 - After 12 months: ~ 70%.

UPG BATTERY

Same specifications as previous Jolt models; packaging and part numbers are the only changes.

UB12260 (was SA12260) Diagrams

UB12260/SA12260 discharge current vs. time

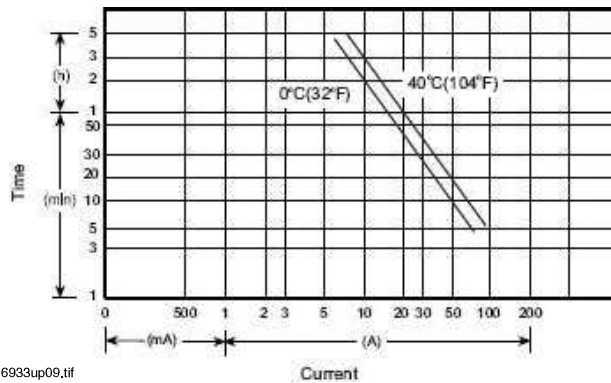

6933up09.tif

UB12260/SA12260 discharge characteristics (25°C/77°F)

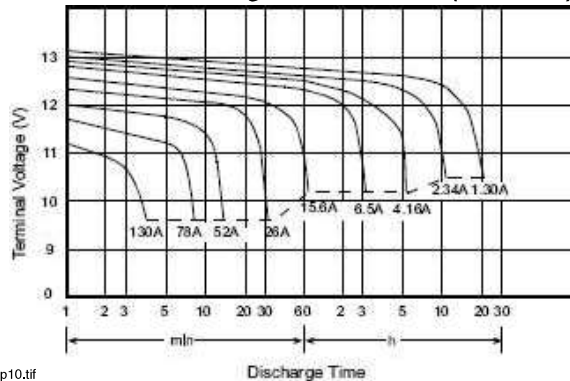

6933up10.tif

UB12260, SA12260 Specifications

- Nominal voltage: 12 V.
- Nominal capacity (20 hr): 26.0 AH.
- Dimensions: total height 125 mm (4.92"); container height 125 mm (4.92"); length 166 mm (6.54"); width 175 mm (6.89").
- Weight: approximately 8.80 kg (19.40 lbs).
- Container material: UL94HB ABS, UL94V-0 ABS.
- Internal resistance (25°C, 77°F): ~ 10 m.
- Discharge capacity under different temperatures:
 - 40°C: ~ 102%
 - 25°C: ~ 100%
 - 0°C: ~ 85%
- Capacity 25°C/77°F:
 - 20 hr @ 1.3 A: 26.0 AH.
 - 5 hr @ 4.16 A: 20.8 AH.
 - 1 hr @ 15.6 A: 15.6 AH.
 - 1 C @ 26.0 A: 13.0 AH.
- Charging voltage (25°C, 77°F):
 - Standby use: 13.65 V ± 0.15 V.
 - Cycle use: 14.7 V ± 0.3 V.
- Maximum discharge current: 300 A (5 sec).
- Maximum charging current: 7.8 A.
- Self-discharge residual capacity (25°C, 77°F):
 - After 3 months: ~ 90%.
 - After 6 months: ~ 82%.
 - After 12 months: ~ 70%.

UB12550 (was SA12550) Diagrams

UB12550/SA12550 discharge current vs. time

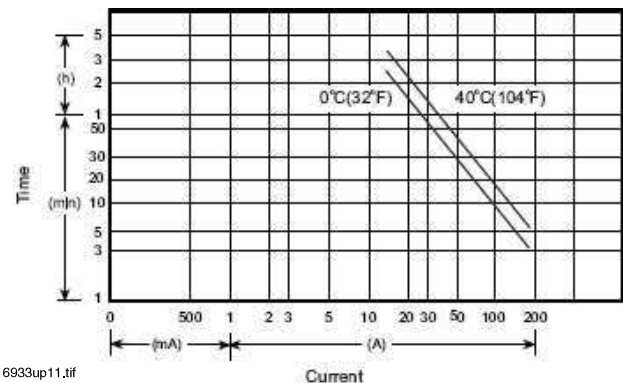

6933up11.tif

UB12550/SA12550 discharge characteristics (25°C/77°F)

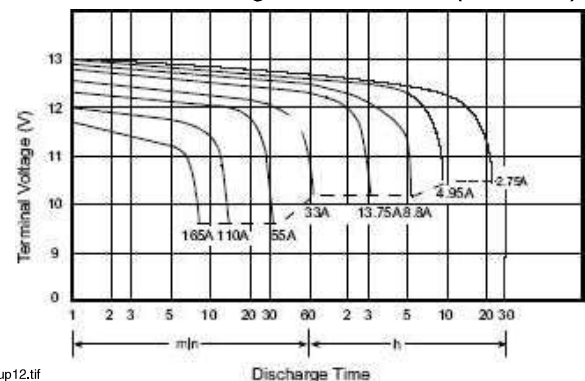

6933up12.tif

UB12550, SA12550 Specifications

- Nominal voltage: 12 V.
- Nominal capacity (20 hr): 55.0 AH.
- Dimensions: total height 234.5 mm (9.23"); container height 216.5 mm (8.52"); length 229 mm (9.02"); width 138 mm (5.43").
- Weight: approximately 19.0 kg (41.8 lbs).
- Container material: UL94HB ABS, UL94V-0 ABS.
- Internal resistance (25°C, 77°F): ~ 8 m.
- Discharge capacity under different temperatures:
 - 40°C: ~ 102%
 - 25°C: ~ 100%
 - 0°C: ~ 85%
- Capacity 25°C/77°F:
 - 20 hr @ 2.75 A: 55.0 AH.
 - 5 hr @ 8.8 A: 44.0 AH.
 - 1 hr @ 33.0 A: 33.0 AH.
 - 1 C @ 55.0 A: 27.5 AH.
- Charging voltage (25°C, 77°F):
 - Standby use: 13.65 V ± 0.15 V.
 - Cycle use: 14.7 V ± 0.3 V.
- Maximum discharge current: 600 A (5 sec).
- Maximum charging current: 16.5 A.
- Self-discharge residual capacity (25°C, 77°F):
 - After 3 months: ~ 90%.
 - After 6 months: ~ 82%.
 - After 12 months: ~ 70%.

UPG BATTERY

Same specifications as previous Jolt models; packaging and part numbers are the only changes.

UB121000 (XSA121000A) Diagrams

UB121000/XSA121000A discharge current vs. time

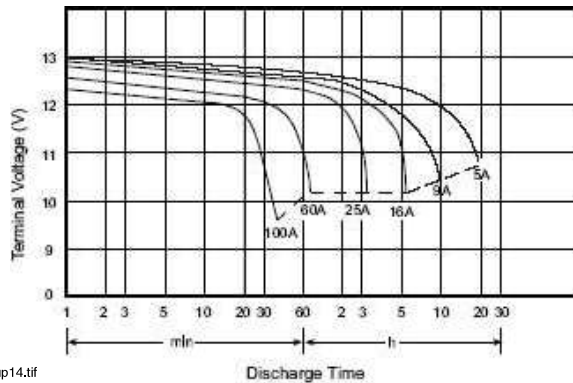
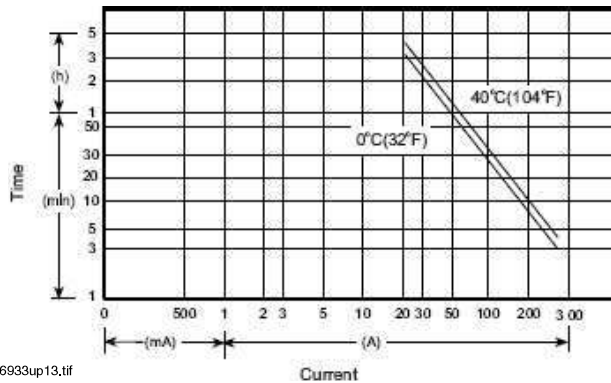

UB121000 (XSA121000A) Diagrams

- Nominal voltage: 12 V.
- Nominal capacity (20 hr): 100.0 AH.
- Dimensions: total height 221 mm (8.70"); container height 214 mm (8.43"); length 329 mm (12.95"); width 172 mm (6.77").
- Weight: approximately 34.00 kg (74.8 lbs).
- Container material: UL94HB ABS, UL94V-0 ABS.
- Internal resistance (25°C, 77°F): ~ 6.5 m.
- Discharge capacity under different temperatures:
 - 40°C: ~ 102%
 - 25°C: ~ 100%
 - 0°C: ~ 85%
- Capacity 25°C/77°F:
 - 20 hr @ 5.0 A: 100.0 AH.
 - 5 hr @ 16.0 A: 80.0 AH.
 - 1 hr @ 60.0 A: 60.0 AH.
 - 1 C @ 100.0 A: 50.0 AH.
- Charging voltage (25°C, 77°F):
 - Standby use: 13.65 V ± 0.15 V.
 - Cycle use: 14.7 V ± 0.3 V.
- Maximum discharge current: 600 A (5 sec).
- Maximum charging current: 30 A.
- Self-discharge residual capacity (25°C, 77°F):
 - After 3 months: ~ 90%.
 - After 6 months: ~ 82%.
 - After 12 months: ~ 70%.

UPG Summary Diagrams

Summary discharge characteristics

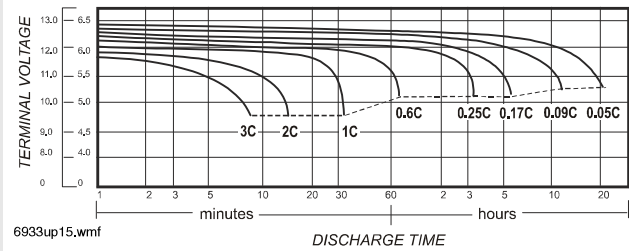

Summary discharge current vs. time curve (25°C/77°F)

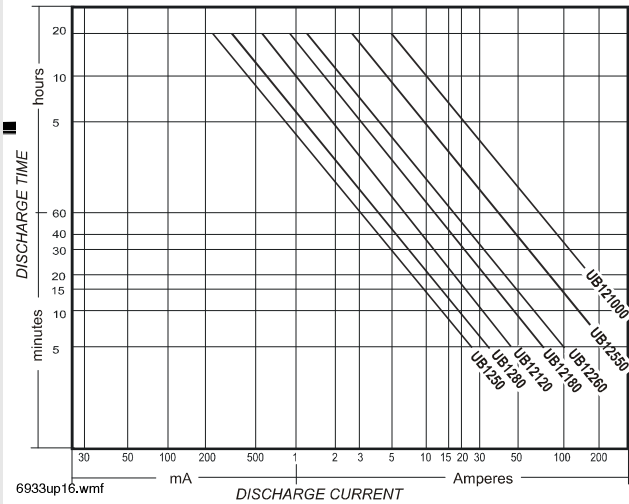

UPG BATTERY

Same specifications as previous Jolt models;
packaging and part numbers are the only changes.

Charging Procedure: UPG Battery

Application	Charging method	Charging voltage at 25°C (V/cell)	Temperature compensation coefficient of charging voltage (mV/°C/cell)	Maximum charging current (CA)	Charging time 0.1 CA, 25°C (h)		Temp (°C)
					100% discharge	50% discharge	
For standby power source	Constant voltage and constant current charging (with current restriction)	2.25 ~ 2.30	- 3.3 (-1.8 mV/°F/cell)	0.3	T ³ 24	T ³ 20	0 – 40°C (32 – 104°F)
For cycle service		2.40 ~ 2.50	- 5 (-2.8 mV/°F/cell)	0.3	16 < T < 24	10 < T < 24	

Temperature compensation of charging voltage is not needed when using the batteries within 5°C to 35°C range.

NOTIFIER® is a registered trademark of Honeywell International Inc.
Batteries display trademarks of the manufacturer.
©2009 by Honeywell International Inc. All rights reserved. Unauthorized use
of this document is strictly prohibited.



This document is not intended to be used for installation purposes.
We try to keep our product information up-to-date and accurate.
We cannot cover all specific applications or anticipate all requirements.
All specifications are subject to change without notice.

For more information, contact Notifier. Phone: (203) 484-7161, FAX: (203) 484-7118,
www.notifier.com

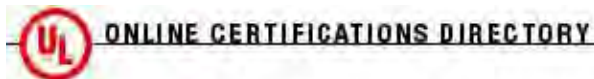

BAZR2.MH20845 Batteries, Standby - Component

[Page Bottom](#)

Batteries, Standby - Component

[See General Information for Batteries, Standby - Component](#)

POWER-SONIC CORP
7550 PANASONIC WAY
SAN DIEGO, CA 92154 USA

MH20845

Model	Max Discharge Rate		Min Charge Rate		Operating Range °C	Battery Case Flame Rating	External Battery Supply Enclosure Investigated For
	Amps	Hr	Amps	Hr			
Batteries, sealed cell lead-acid.							
PS-612	—	—	—	—	—	HB	—
PS-630	—	—	—	—	—	HB	—
PS-640	—	—	—	—	—	HB	—
PS-6100	—	—	—	—	—	HB	—
PS-1208	—	—	—	—	—	HB	—
PS-1212	—	—	—	—	—	—	—
PS-1220	—	—	—	—	—	HB	—
PS-1230	—	—	—	—	—	HB	—
PS-1270	—	—	—	—	—	HB	—
PS-12120	—	—	—	—	—	HB	—
PS-12260	—	—	—	—	—	HB	—
PS-12550	—	—	—	—	—	HB	—
PS-12750	—	—	—	—	—	HB	—
PS-121000	—	—	—	—	—	HB	—
PS-632	—	—	—	—	—	—	—
PS1223	—	—	—	—	—	—	—
PS-1290	—	—	—	—	—	—	—
PS-445	—	—	—	—	—	HB	—
PS-625	—	—	—	—	—	HB	—
PS-1228	—	—	—	—	—	HB	—
PS-1229	—	—	—	—	—	HB	—
PSH-655	—	—	—	—	—	HB	—
PS-1221	—	—	—	—	—	—	—
PS-1221-S	—	—	—	—	—	—	—
PG12V28	—	—	—	—	—	—	—
PG12V42	—	—	—	—	—	—	—

PG12V55	—	—	—	—	—	HB	—
PG12V65	—	—	—	—	—	HB	—
PG12V75	—	—	—	—	—	HB	—
PG12V75T	—	—	—	—	—	HB	—
PG12V92	—	—	—	—	—	—	—
PG12V103	—	—	—	—	—	—	—
PG12V120	—	—	—	—	—	—	—
PG12V140	—	—	—	—	—	—	—
PG12V150	—	—	—	—	—	HB	—
PG12V200	—	—	—	—	—	HB	—
PS-1272	—	—	—	—	—	HB	—
PS-1272 F1	—	—	—	—	—	—	—
PS-1272 F2	—	—	—	—	—	—	—
PS-12180	—	—	—	—	—	HB	—
PSH-12180	—	—	—	—	—	—	—
PS-6580	—	—	—	—	—	—	—
PSH-655	—	—	—	—	—	HB	—
PS-6200B	—	—	—	—	—	HB	—
PG-6V210	—	—	—	—	—	HB	—
PS-12350	—	—	—	—	—	HB	—
PS-4100	—	—	—	—	—	HB	—
PS-605WL	—	—	—	—	—	HB	—
PSG-450	—	—	—	—	—	HB	—
PSG-480	—	—	—	—	—	HB	—
PSG-625	—	—	—	—	—	HB	—
PSG-650	—	—	—	—	—	HB	—
PSG-680	—	—	—	—	—	HB	—
PS-445	—	—	—	—	—	HB	—
PS-490	—	—	—	—	—	HB	—
PS-610	—	—	—	—	—	HB	—
PS-612	—	—	—	—	—	HB	—
PS-628	—	—	—	—	—	HB	—
PS-630	—	—	—	—	—	—	—
PS-640F1	—	—	—	—	—	HB	—
PS-650LS	—	—	—	—	—	HB	—
PS-665P	—	—	—	—	—	HB	—
PS-670	—	—	—	—	—	—	—
PS-682F1	—	—	—	—	—	HB	—
PS-6100F1	—	—	—	—	—	HB	—
PS-6100F2	—	—	—	—	—	HB	—
PS-6120FP	—	—	—	—	—	HB	—
PS-6120TS	—	—	—	—	—	HB	—

PS-6120TH	—	—	—	—	—	HB	—
PS-6200	—	—	—	—	—	HB	—
PS-6360F2	—	—	—	—	—	—	—
PS-6360NB	—	—	—	—	—	—	—
PS-6580	—	—	—	—	—	—	—
PS-832	—	—	—	—	—	—	—
PS-1212	—	—	—	—	—	—	—
PS-1220	—	—	—	—	—	—	—
PS-1227	—	—	—	—	—	HB	—
PS-1230	—	—	—	—	—	HB	—
PS-1238	—	—	—	—	—	HB	—
PS-1250F1	—	—	—	—	—	HB	—
PS-1270F1	—	—	—	—	—	—	—
PS-1270F2	—	—	—	—	—	—	—
PS-1290F2	—	—	—	—	—	—	—
PS-12120F2	—	—	—	—	—	—	—
PS-12180F2	—	—	—	—	—	HB	—
PS-12260NB	—	—	—	—	—	HB	—
PS-12280NB	—	—	—	—	—	HB	—
PS-12330NB	—	—	—	—	—	—	—
PS-12400NB	—	—	—	—	—	HB	—
PS-12400	—	—	—	—	—	HB	—
PS-12550U	—	—	—	—	—	HB	—
PS-12750U	—	—	—	—	—	HB	—
PS-121000U	—	—	—	—	—	—	—
PS-121100B	—	—	—	—	—	—	—
PS-121400B	—	—	—	—	—	—	—
PSH-1255F2	—	—	—	—	—	HB	—
PSH-12100F2	—	—	—	—	—	—	—
PS-650L	—	—	—	—	—	HB	—
PS-6100F2	—	—	—	—	—	HB	—
PS-1250F2	—	—	—	—	—	HB	—
PS-12180NB	—	—	—	—	—	HB	—
PSH-1280F2	—	—	—	—	—	—	—
PSH-12100	—	—	—	—	—	—	—
PS-1270PBR	—	—	—	—	—	—	—
PS-12140PBR	—	—	—	—	—	—	—
SA-6100	—	—	—	—	—	HB	—
SA-12100	—	—	—	—	—	HB	—
SA-24100	—	—	—	—	—	HB	—
PS-1282	—	—	—	—	—	HB	—
PS-12100	—	—	—	—	—	HB	—

PS-1290H	—	—	—	—	—	—	—
PS-1290F2	—	—	—	—	—	—	—
PS-12330	—	—	—	—	—	—	—
Sealed cell, lead acid batteries with pressure release vents.							
DCG12-15	—	—	—	—	—	HB	—
DCG12-26	—	—	—	—	—	HB	—
DCG12-31	—	—	—	—	—	HB	—
DCG12-38	—	—	—	—	—	HB	—
DCG12-50	—	—	—	—	—	HB	—
DCG12-70	—	—	—	—	—	HB	—
DCG12-100	—	—	—	—	—	—	—
PS-1208WL	—	—	—	—	—	HB	—
PS-1223	—	—	—	—	—	HB	—
PS1229	—	—	—	—	—	HB	—
PSG-12170 B	—	—	—	—	—	HB	—
120072260208, 120072340208	—	—	—	—	—	HB	—
PSG-12400 B	—	—	—	—	—	HB	—
PSG-121000 B	—	—	—	—	—	HB	—
PSG-121100 B	—	—	—	—	—	HB	—
PSG-12260 B	—	—	—	—	—	HB	—
PSG12310 B	—	—	—	—	—	—	—
PSG-12550 B	—	—	—	—	—	HB	—
PSG-12700 B	—	—	—	—	—	HB	—
PSG-122000 B	—	—	—	—	—	HB	—
PSG-121500 B	—	—	—	—	—	HB	—
PS-122000	—	—	—	—	—	HB	—
060012260208	—	—	—	—	—	HB	—
060065290208	—	—	—	—	—	HB	—
060100260208	—	—	—	—	—	HB	—
120012260208	—	—	—	—	—	HB	—
120070260208	—	—	—	—	—	HB	—
120070260215	—	—	—	—	—	HB	—
120120340215	—	—	—	—	—	HB	—
120120340208	—	—	—	—	—	HB	—
120182340208	—	—	—	—	—	HB	—
120055340708	—	—	—	—	—	V-0	—
120180400708	—	—	—	—	—	V-0	—
120028290208	—	—	—	—	—	HB	—
Sealed cell, lead acid batteries with pressure release vents.							
120350400208	—	—	—	—	—	HB	—
120070340208	—	—	—	—	—	HB	—
120400400208	—	—	—	—	—	HB	—

120040260208	—	—	—	—	—	HB	—
120050260208	—	—	—	—	—	HB	—
120182400208	—	—	—	—	—	HB	—
120029260208	—	—	—	—	—	HB	—
120020260208	—	—	—	—	—	HB	—
060100340208	—	—	—	—	—	HB	—
120050340208	—	—	—	—	—	HB	—
060082260208	—	—	—	—	—	HB	—
020060260208	—	—	—	—	—	HB	—
060360340208	—	—	—	—	—	HB	—
120021260208	—	—	—	—	—	HB	—
PSH 655 FR	—	—	—	—	—	HB	—
PSH 1255 F2 FR	—	—	—	—	—	HB	—
PSH 1280 F2 FR	—	—	—	—	—	HB	—
PSH 12100 F2 FR	—	—	—	—	—	HB	—
PSH 12180 F2/NB FR	—	—	—	—	—	HB	—

Marking: Company name and model number on battery case or cover.

Last Updated on 2010-04-02

[Questions?](#)

[Print this page](#)

[Notice of Disclaimer](#)

[Page Top](#)

[Copyright © 2011 Underwriters Laboratories Inc.®](#)

The appearance of a company's name or product in this database does not in itself assure that products so identified have been manufactured under UL's Follow-Up Service. Only those products bearing the UL Mark should be considered to be Listed and covered under UL's Follow-Up Service. Always look for the Mark on the product.

UL permits the reproduction of the material contained in the Online Certification Directory subject to the following conditions: 1. The Guide Information, Designs and/or Listings (files) must be presented in their entirety and in a non-misleading manner, without any manipulation of the data (or drawings). 2. The statement "Reprinted from the Online Certifications Directory with permission from Underwriters Laboratories Inc." must appear adjacent to the extracted material. In addition, the reprinted material must include a copyright notice in the following format: "Copyright © 2011 Underwriters Laboratories Inc.®"

An independent organization working for a safer world with integrity, precision and knowledge.



