

*ALARM AND DETECTION SYSTEMS CONTRACTORS  
NEW ORLEANS - BATON ROUGE - OCEAN SPRINGS*



**FIRE ALARM SUBMITTAL**  
**HOLY FAMILY ACADEMY**  
**BUILDING B**

**18080 SAINT JOSEPH WAY COVINGTON LA**

**ADS 6654FA**

**Date:05/21/2025**

**DESIGNED BY: WAYNE GUILLOT JR**  
**SOLD BY: WAYNE LEVET**

SECTION 1  
Equipment List

SECTION 2  
Data Sheets & Uls

SECTION 3  
Battery Calculations

**SHOP DRAWING / SUBMITTAL REVIEW**

REVIEWED                       REVIEWED AS NOTED  
 REVISE AND RESUBMIT     REJECTED

Project No.: 2527                      Submittal No.: 283110.01

Corrections or comments made on the shop drawings during this review do not relieve the contractor from compliance with requirements of the drawings and specifications. This check is only for review of the general conformance with the design concept of the project and general compliance with the information given in the contract documents. This contractor is responsible for: confirming and correlating all quantities and dimensions; selecting fabrication processes and techniques of construction; coordinating his or her work with that and other trades and performing all in a safe and satisfactory manner.

By: David Dammon                      Date: 5/21/2026

**DAMMON ENGINEERING, INC.**  
Slidell, LA

HOLY FAMILY ACADEMY  
COVINGTON, LA

**HOLY FAMILY ACADEMY BUILDING B**  
**FIRE ALARM EQUIPMENT LIST**

<b><u>QTY</u></b>	<b><u>MODEL</u></b>	<b><u>DESCRIPTION</u></b>
<b>EXISTING</b>	NFS2-640	NOTIFIER FIRE ALARM CONTROL PANEL
01	HPF-PS6B	FIELD CHARGING POWER SUPPLY
02	NBG-12LX	NOTIFIER ADDRESSABLE PULL STATION
15	FSP-951	ADDRESSABLE SMOKE DETECTOR
15	B300-6	WHITE 6" BASE STANDARD FLANGE LOW PROFILE MOUNTING BASE
14	SWLED	SYSTEM SENSOR WALL MOUNT STROBE WHITE
03	SPSWLED	SYSTEM SENSOR WALL MOUNT SPEAKER STROBE WHITE
02	IM-12180F2	18AMP HOUR STANDBY BATTERIES

# NFS2-640 Intelligent Addressable Fire Alarm Control Panel

## General

The NFS2-640 intelligent Fire Alarm Control Panel is part of the ONYX® Series of Fire Alarm Controls from NOTIFIER.

In stand-alone or network configurations, ONYX Series products meet virtually every application requirement.

The NFS2-640's modular design makes system planning easier. The panel can be configured with just a few devices for small building applications, or networked with many devices to protect a large campus or a high-rise office block. Simply add additional peripheral equipment to suit the application.

A host of other options are available, including single- or multichannel voice; firefighter's telephone; LED, LCD, or PC-based graphic annunciators; networking; advanced detection products for challenging environments; wireless fire protection; and many additional options.

**NOTE:** Unless called out with a version-specific "E" at the end of the part number, "NFS2-640" refers to models NFS2-640 and NFS2-640E; similarly, "CPU2-640" refers to models CPU2-640 and CPU2-640E.

ONYX® Series panels integrate with the Connected Life Safety Services (CLSS) platform through the CLSS Gateway, providing connectivity to central station, cloud, and mobile applications. (See HON-62034.) This cloud-based functionality provides reliable protection and remote monitoring of the system, reduced manual data entry, and reporting.

## Features

- Certified for seismic applications when used with the appropriate seismic mounting kit.
- Approved for Marine applications when used with listed compatible equipment. See DN-60688.
- One, expandable to two, isolated intelligent Signaling Line Circuit (SLC) Class A, B, or X.
- Wireless fire protection using SWIFT Smart Wireless Integrated Fire Technology. See DN-60820.
- Up to 159 detectors and 159 modules per SLC; 318 devices per loop/636 per FACP or network node.
  - Detectors can be any mix of photo, thermal, or multi-sensor; wireless detectors are available for use with the FWSG(A).
  - Modules include addressable pull stations, normally open contact devices, two-wire smoke detectors, notification, or relay; wireless modules are available for use with the FWSG(A).
- Standard 80-character display, 640-character large display (NCA-2), or display-less (a node on a network).
- Network options:
  - High-speed network for up to 200 nodes (N16e/x, NFS2-3030, NFS2-640, NFS-320(C), NFS-320SYS, NCD, NCA-2, DVC-EM, ONYXWorks, NFS-3030, NFS-640, and NCA).
  - Standard network for up to 103 nodes (N16e/x, NFS2-3030, NFS2-640, NFS-320(C), NFS-320SYS, NCD, NCA-2, DVC-EM, ONYXWorks, NCS, NFS-3030, NFS-640, NCA, AFP-200, AFP-300/400, AFP-1010, and AM2020). Up to 54 nodes when DVC-EM is used in network paging.
- 6.0 A switch mode power supply with four Class A/B built-in Notification Appliance Circuits (NAC). Selectable System Sensor, Wheelock, or Gentex strobe synchronization.
- Built-in Alarm, Trouble, Security, and Supervisory relays.
- Optional cloud connectivity for remote off site monitoring through CLSS (see HON-62034)
- Monitor multiple buildings through one off-campus central station, and report through the CLSS Gateway
- Optional remote programming through CLSS
- Field-programmable on panel or on PC.
- VeriFire® Tools online or offline programming utility. Upload/Download, save, store, check, compare, and simulate panel databases. Upgrade panel firmware.
- Autoprogramming and Walk Test reports.
- Multiple central station communication options:
  - Standard UDACT
  - Internet
  - Internet/GSM
- 80-character remote annunciators (up to 32).
- EIA-485 annunciators, including custom graphics.
- Printer interface (80-column and 40-column printers).
- History file with 800-event capacity in nonvolatile memory, plus separate 200-event alarm-only file.
- Alarm Verification selection per point, with automatic counter.
- Presignal/Positive Alarm Sequence (PAS).
- Silence inhibit and Auto Silence timer options.
- March time/temporal/California two-stage coding/strobe synchronization.
- Full QWERTY keypad.
- Battery charger supports 18 – 200 AH batteries.
- Non-alarm points for lower priority functions.
- Remote ACK/Signal Silence/System Reset/Drill using monitor modules.
- Automatic time control functions, with holiday exceptions.
- Surface Mount Technology (SMT) electronics.
- Extensive, built-in transient protection.



- Powerful Boolean logic equations.
- Support for SCS Series smoke control system in HVAC mode.

**NCA-2 AS PRIMARY DISPLAY**

- Backlit, 640-character display.
- Supports SCS Series smoke control system in FSCS mode when SCS is connected to the NCA-2 used as primary display.
- Supports DVC digital audio loop.
- Printer and CRT EIA-232 ports.
- EIA-485 annunciator and terminal mode ports.
- Alarm, Trouble, Supervisory, and Security relays.

**SWIFT WIRELESS**

- Self-healing mesh wireless protocol.
- Each SWIFT Gateway supports up to 49 SWIFT devices.
- Up to 4 wireless gateways can be installed with overlapping network coverage.

**RELEASING FEATURES**

- Ten independent hazards.
- Sophisticated cross-zone (three options).
- Delay timer and Discharge timers (adjustable).
- Abort (four options).
- Low-pressure CO<sub>2</sub> listed.

**DIGITAL VOICE AND TELEPHONE FEATURES**

- Up to eight channels of digital audio.
- 35, 50, 75, and 100/125 watt digital amplifiers (DAA2/DAX series and DS series; NCA-2/C required as primary display).
- Solid-state digital message generation.
- Firefighter telephone option.

- 30- to 120-watt high-efficiency amplifiers (AA Series).
- Backup tone generator and amplifier option.
- NFS2-640 can also integrate with the FirstCommand® Emergency Communications System. See DN-60772.

**HIGH-EFFICIENCY OFFLINE SWITCHING**

**3.0 A POWER SUPPLY (6.0 A IN ALARM)**

- 120 VAC (NFS2-640); 240 VAC (NFS2-640E).
- Displays battery current/voltage on panel (with display).

**FLASHSCAN® INTELLIGENT FEATURES**

- Polls up to 318 devices in less than two seconds.
- Activates up to 159 outputs in less than five seconds.
- Multicolor LEDs blink device address during Walk Test.
- Fully digital, high-precision protocol (U.S. Patent 5,539,389).
- Manual sensitivity adjustment — up to nine levels.
- Pre-alarm ONYX intelligent sensing — up to nine levels.
- Day/Night automatic sensitivity adjustment.
- Sensitivity windows:
  - Photo — 0.5 to 2.35%/foot obscuration.
  - High-Sensitivity Photoelectric (VIEW®) — Open Air Protection (0.5% - 2.0%/ft. obscuration), Special Applications (0.02%-0.5%/ft. obscuration)
  - Multi-Criteria Detector — Open Air Protection (2.52-3.89%/ft. obscuration), Special Applications (1.13-2.52%/ft. obscuration)
- Drift compensation (U.S. Patent 5,764,142).
- Degraded mode: In the unlikely event that the CPU2-640 microprocessor fails, FlashScan detectors revert to degraded operation and can activate the CPU2-640 NAC circuits and alarm relay. Each of the four built-in panel circuits includes a Disable/Enable switch for this feature.

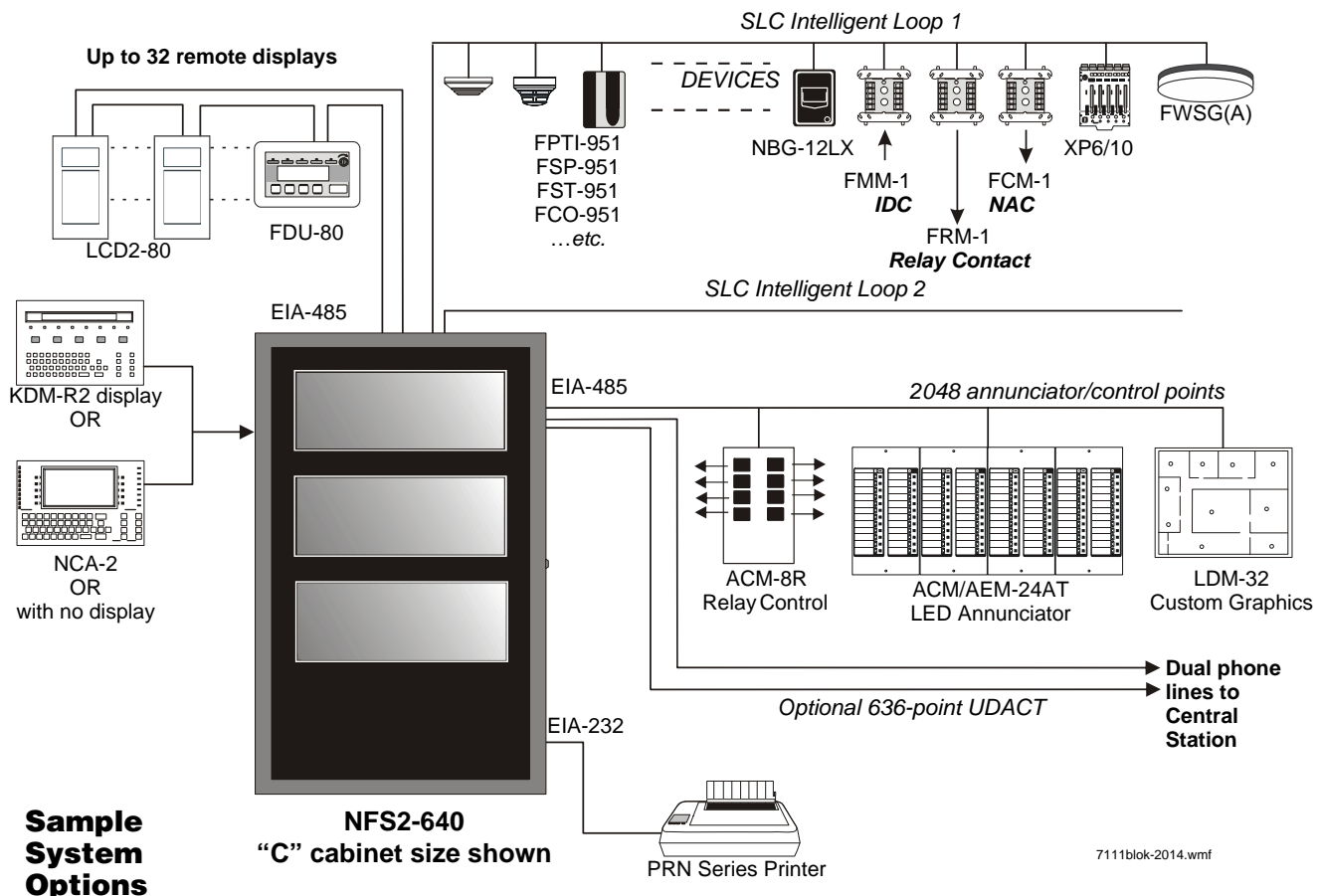

7111blok-2014.wmf

- Multi-detector algorithm involves nearby detectors in alarm decision (U.S. Patent 5,627,515).
- Automatic detector sensitivity testing (NFPA-72 compliant).
- Maintenance alert (two levels).
- Self-optimizing pre-alarm.

**FSV-951 SERIES VIEW® (VERY INTELLIGENT EARLY WARNING) HIGH-SENSITIVITY SMOKE DETECTOR**

- Advanced ONYX intelligent sensing algorithms differentiate between smoke and non-smoke signals.
- Addressable operation pinpoints the fire location.
- Ivory models (-IV) support CLIP mode as well as FlashScan.
- ULC listed models available; "A" models are ULC Listed.
- -R is retrofit, backwards compatible for use with older panels.

**FCO-951/-IV ADVANCED MULTI-CRITERIA FIRE/CO DETECTOR**

- Detects all four major elements of a fire (smoke, heat, CO, and flame).
- 135°F (57.2°C) fixed-temperature heat detector.
- Transmits an alarm signal due to heat.
- Separate signal for life-safety CO detection.
- Optional addressable sounder base for Temp-3 (fire) or Temp-4 (CO) tone.
- Automatic drift compensation of smoke sensor and CO cell.
- High nuisance-alarm immunity.
- ULC listed models available; -A models are ULC Listed.

**FPTI-951(A) INTELLIGENT MULTI-CRITERIA DETECTOR**

- Combined Photoelectric Thermal and Infrared Sensor
- UL 268 7th Edition and UL 521 Listed; Canadian models CAN/ULC S529 and CAN/ULC S530
- Microprocessor-based technology; combination photo, thermal, and infrared technology.

**FPC-951(A) PHOTOELECTRIC/CO SENSOR**

- Combined photoelectric and carbon monoxide sensor

**FSCO-95(A) INTELLIGENT CO SENSOR**

- Carbon monoxide sensor

**FS-OSI-RI(A) ADDRESSABLE INTELLIGENT SINGLE-ENDED BEAM SMOKE DETECTOR**

- Intelligent addressable reflector-type linear optical beam smoke detector
- Fast, easy, and intuitive beam alignment indicated by directional LED arrows
- Long range coverage of 16-328 ft (5-100 m) is standard; no separate long-range kit required

**FMM-4-20 GAS DETECTION MODULE**

- Interface to industry-standard linear scale 4-20 mA sensors.
- Five programmable thresholds.
- FM Approved, Class 6320 (Stationary Gas Sensors/Detectors).

**INTELLIGENT VESDA-E DETECTORS**

- Intelligent aspiration smoke detectors connect directly to the SLC loop of compatible ONYX® Series panels:
  - VEA-040-A00-NTF, VEA-040-A10-NTF
  - VEP-A00-P-NTF, VEP-A10-P-NTF, VEP-A00-1P-NTF
  - VEU-A00-NTF, VEU-A10-NTF
  - VES-A00-P-NTF-UL, VES-A10-P-NTF-UL
- Models offer LED display, LCD display, or both
- Coverage options for spaces up to 69,965 square feet

**FlashScan, Exclusive World-Leading Detector Protocol**

At the heart of the NFS2-640 is a set of detection devices and device protocol — FlashScan (U.S. Patent 5,539,389). FlashScan is an all-digital protocol that gives superior precision and high noise immunity.

In addition to providing quick identification of an active input device, this protocol can also activate many output devices in a fraction of the time required by competitive protocols. This high speed also allows the NFS2-640 to have the largest device per loop capacity in the industry — 318 points — yet every input and output device is sampled in less than two seconds. The microprocessor-based FlashScan detectors have bicolor LEDs that can be coded to provide diagnostic information, such as device address during Walk Test.

**ONYX Intelligent Sensing**

Intelligent sensing is a set of software algorithms that provides the NFS2-640 with industry-leading smoke detection capability. These complex algorithms require many calculations on each reading of each detector, and are made possible by the high-speed microcomputer used by the NFS2-640.

**Drift Compensation and Smoothing:** Drift compensation allows the detector to retain its original ability to detect actual smoke, and resist false alarms, even as dirt accumulates. It reduces maintenance requirements by allowing the system to automatically perform the periodic sensitivity measurements required by NFPA 72. Smoothing filters are also provided by software to remove transient noise signals, such as those caused by electrical interference.

**Maintenance Warnings:** When the drift compensation performed for a detector reaches a certain level, the performance of the detector may be compromised, and special warnings are given. There are three warning levels: (1) Low Chamber value; (2) Maintenance Alert, indicative of dust accumulation that is near but below the allowed limit; (3) Maintenance Urgent, indicative of dust accumulation above the allowed limit.

**Sensitivity Adjust:** Nine sensitivity levels are provided for alarm detection. These levels can be set manually, or can change automatically between day and night. Nine levels of pre-alarm sensitivity can also be selected, based on predetermined levels of alarm. Pre-alarm operation can be latching or self-restoring, and can be used to activate special control functions.

**Self-Optimizing Pre-Alarm:** Each detector may be set for "Self-Optimizing" pre-alarm. In this special mode, the detector "learns" its normal environment, measuring the peak analog readings over a long period of time, and setting the pre-alarm level just above these normal peaks.

**Cooperating Multi-Detector Sensing:** A patented feature of ONYX intelligent sensing is the ability of a smoke sensor to consider readings from nearby sensors in making alarm or pre-alarm decisions. Without statistical sacrifice in the ability to resist false alarms, it allows a sensor to increase its sensitivity to actual smoke by a factor of almost two to one.

**Field Programming Options**

**Autoprogram** is a timesaving feature. The FACP "learns" what devices are physically connected and automatically loads them in the program with default values for all parameters. Requiring less than one minute to run, this routine allows the user to have almost immediate fire protection in a new installation, even if only a portion of the detectors are installed.

**Keypad Program Edit (with KDM-R2)** The NFS2-640, like all NOTIFIER intelligent panels, has the exclusive feature of program creation and editing capability from the front panel keypad, while continuing to provide fire protection. The architecture of the NFS2-640 software is such that each point entry carries its own program, including control-by-event links to other points. This allows the program to be entered with independent per-point segments, while the

NFS2-640 simultaneously monitors other (already installed) points for alarm conditions.

**VeriFire® Tools** is an offline programming and test utility that can greatly reduce installation programming time, and increase confidence in the site-specific software. It is Windows®-based and provides technologically advanced capabilities to aid the installer. The installer may create the entire program for the NFS2-640 in the comfort of the office, test it, store a backup file, then bring it to the site and download from a laptop into the panel.

## Placement of Equipment in Chassis and Cabinet

The following guidelines outline the NFS2-640's flexible system design.

**Rows:** The first row of equipment in the cabinet mounts in the chassis shipped with the FACP. Mount the second, third, or fourth rows of equipment in a CHS-4 series chassis or, for Digital Voice Command products, in CA-1 or CA-2. (For DVC-EM and DAA2/DAX components see *DVC Manual*; for DS series components see *DS-AMP Manual*; for DVC-AO applications, see *AA Series Installation Manual*). Other options are available; see your panel's installation manual.

**Wiring:** When designing the cabinet layout, consider separation of power-limited and non-power-limited wiring as discussed in the *NFS2-640 Installation Manual*.

**Positions:** A chassis offers four basic side-by-side positions for components; the number of modules that can be mounted in each position depends on the chassis model and the size of the individual module. There are a variety of standoffs and hardware items available for different combinations and configurations of components.

It is critical that all mounting holes of the NFS2-640 are secured with a screw or standoff to ensure continuity of Earth Ground.

**Layers:** The control panel's chassis accepts four layers of equipment, including the control panel. The CPU2-640 fills three positions (left to right) in the first-installed layer (the back of the chassis); its integral power supply occupies the center two positions in the next two layers; the optional display occupies (the left) two positions at the front, flush with the door. Some equipment, such as the NCA-2, may be mounted in the dress panel directly in front of the control panel. The NCA-2 can be used as a primary display for the NFS2-640 (use NCA/640-2-KIT) by directly connecting their network ports (required in Canadian stand-alone applications); see NCA-2 data sheet for mounting options (*DN-7047*).

**Expansion:** Installing an LEM-320 Loop Expander Module adds a second SLC loop to the control panel. The LEM-320 is mounted onto the CPU2-640, occupying the middle-right, second (back) slot on the chassis.

**Networking:** If networking two or more control panels, each unit requires a Network Communication Module or High-Speed Network Communication Module. (HS-NCM can support two nodes; see "Networking Options" on page 5). These modules can be installed in any option board position (see manual), and additional option boards can be mounted in front of the network communication modules.

## KDM-R2 Controls and Indicators

**Program Keypad:** QWERTY type (*keyboard layout, see figure*).

**12 LED indicators:** Power; Fire Alarm; Pre-Alarm; Security; Supervisory; System Trouble; Signals Silenced; Points Disabled; Control Active; Abort; Pre-Discharge; Discharge.

**Keypad Switch Controls:** Acknowledge/Scroll Display; Signal Silence; Drill; System Reset; Lamp Test.

**LCD Display:** 80 characters (2 x 40) with long-life LED backlight.

## Product Line Information

- "Configuration Guidelines" on page 4
- "Main System Components" on page 4
- "Networking Options" on page 5
- "Auxiliary Power Supplies and Batteries" on page 5
- "Audio Options" on page 5
- "Compatible Devices, EIA-232 Ports" on page 5
- "Compatible Devices, EIA-485 Ports" on page 6
- "Compatible Intelligent Devices" on page 6
- "Enclosures, Chassis, and Dress Plates" on page 7
- "Other Options" on page 8

### CONFIGURATION GUIDELINES

*Stand-alone and network systems require a main display. On systems with one FACP (one CPU2-640/-640E), display options are the KDM-R2 or the NCA-2/C. On network systems (two or more networked fire panel nodes), at least one NCD, NCA-2, NCS, or ONYX-Works annunciation device is required. Other options listed as follows.*

### MAIN SYSTEM COMPONENTS

**CPU2-640:** Central processing unit (CPU) with integral 3.0 A (6.0 A in alarm) power supply for an NFS2-640 system. Includes control panel factory-mounted on a chassis; one Signaling Line Circuit expandable to two; documentation kit. *Order one per system or as necessary (up to 103 network nodes) on a network system. (Non-English versions also available: CPU2-640-FR, CPU2-640-PO, CPU2-640-SP.)*

**CPU2-640E:** Same as CPU2-640 but requires 240 VAC, 1.5 A, (3.0 A in alarm). *(Non-English versions also available: CPU2-640E-PO, CPU2-640E-SP.)*

**KDM-R2:** 80-character backlit LCD display with QWERTY programming and control keypad. Order two BMP-1 blank modules and DP-DISP2 mounting plate separately. *Requires top row of a cabinet. Required for each stand-alone 80-character display system. The KDM-R2 may mount in network nodes to display "local" node information as long as at least one NCA-2 or NCS/ONYXWorks network display is on the system to display network information. (Non-English versions also available: KDM-R2C for ULC application, KDM-R2-FR, KDM-R2-PO, KDM-R2-SP.)*

**NCA-2/C:** Network Control Annunciator, 640 characters. On single CPU2-640/-640E systems, the optional NCA-2 can be used as the Primary Display for the panel and connects directly to the CPU2-640/-640E. On network systems (two or more networked fire panel nodes), one network display (either NCA-2 or NCS/ONYXWorks) is required for every system. On network systems, the NCA-2 connects to (and requires) a standard Network Communication Module or High-Speed Network Communication Module. Mounts in a row of FACP node or in two annunciator positions. Mounting options include the DP-DISP2, ADP-4B, or in an annunciator box, such as the ABS-2D. In CAB-4 top-row applications, a DP-DISP2 and two BMP-1 blank modules are required for mounting. Required for NFS2-640 applications employing the DVC-EM with DAL devices. Non-English versions are available. *NCA-2C are available for ULC applications. For marine applications, order NCA-2-M; for non-English Marine applications, order NCA-2-M and the appropriate KP-KIT-XX. See DN-7047.*

**NCD:** As part of a standalone NFS2-640 system, the NCD can serve as Primary Display for the panel, to provide control and status capabilities on displayless nodes. On network systems, the NCD connects to (and requires) a standard Network Communication Module or High-Speed Network Communication Module. Mounting options include the ABS-TD for standalone applications. In the CAB-4 series the NCD can be mounted in the top row with a DP-GDIS1 or lower rows using a DP-GDIS2. *See DN-60974.*

**NCA/640-2-KIT:** Bracket installation kit required to mount NCA-2 to the CPU2-640/-640E's standard chassis.

**DP-DISP2:** Dress panel for top row in cabinet with CPU2-640/640E installed.

**ADP2-640:** Dress panel for middle rows with CPU2-640/640E.

**BMP-1:** Blank module for unused module positions.

**BP2-4:** Battery plate, required. (*Existing JADT-XLS-BP2-4 may be used in retrofits.*)

**LEM-320:** Loop Expander Module. Expands each NFS2-640 to two Signaling Line Circuits. See DN-6881.

#### **NETWORKING OPTIONS**

**NCM-W, NCM-F:** Standard Network Communications Modules. Wire and multi-mode fiber versions available. See DN-6861.

**HS-NCM-W(-2), HS-NCM-MF, HS-NCM-SF, HS-NCM-WMF(-2), HS-NCM-WSF(-2), HS-NCM-MFSF:** High-speed Network Communications Modules that can connect to two nodes. Wire, single-mode fiber, multi-mode fiber, and media conversion models are available. See DN-60454.

**RPT-W, RPT-F, RPT-WF:** Standard-network repeater board with wire connection (RPT-W), multi-mode fiber connection (RPT-F), or allowing a change in media type between wire and fiber (RPT-WF). Not used with high-speed networks. See DN-6971.

**ONYXWorks:** UL-listed graphics PC workstation, software, and computer hardware. See DN-7048 for specific part numbers.

**NFN-GW-EM-3:** NFN Gateway, embedded. (Replaces NFN-GW-EM.) See DN-60499.

**NWS-3: NOTI•FIRE•NET™** Web Server. See DN-6928.

**CAP-GW:** Common Alerting Protocol Gateway. See DN-60756.

**VESDA-HLI-GW:** VESDAnet high-level interface gateway. See DN-60753.

**LEDSIGN-GW:** UL-listed sign gateway. Interfaces with classic and high-speed NOTI•FIRE•NET networks through the NFN Gateway. See DN-60679.

**OAX2-24V:** UL-listed LED sign, used with LEDSIGN-GW. See DN-60679.

#### **AUXILIARY POWER SUPPLIES AND BATTERIES**

**ACPS-610:** 6.0 A or 10.0 A addressable charging power supply. See DN-60244.

**APS2-6R:** Auxiliary Power Supply. Provides up to 6.0 amperes of power for peripheral devices. Includes battery input and transfer relay, and overcurrent protection. Mounts on two of four positions on a CHS-4L or CHS-4 chassis. See DN-5952.

**FCPS-24S6/S8:** Remote 6 A and 8 A power supplies with battery charger. See DN-6927.

**BAT Series:** Batteries. NFS2-640 uses two 12 volt, 18 to 200 AH batteries. See DN-6933.

#### **AUDIO OPTIONS**

**NOTE:** For mounting hardware, see “Enclosures, Chassis, and Dress Plates” on page 7 and peripheral data sheets.

**DVC-EM:** Digital Voice Command, digital audio processor with message storage for up to 32 minutes of standard quality (4 minutes at high quality) digital audio. Capable of playing up to eight simultaneous messages when used with Digital Audio Loop (DAL) devices. See DN-7045.

**DVC-RPU:** Digital Voice Command Remote Paging Unit for use with DVC-EM. Includes the keypad/display. See DN-60726.

**DS-DB:** Digital Series Distribution Board, provides bulk amplification capabilities to the DVC-EM while retaining digital audio distribution capabilities. Can be configured with up to four DS-AMPs, supplying high-level risers spread throughout an installation. See DN-60565.

**DVC-KD:** DVC-EM keypad for local annunciation and controls; status LEDs and 24 user-programmable buttons. See DN-7045.

**DS-AMP/E:** 125W, 25 VRMS, or 100W, 70VRMS. 70VRMS requires DS-XF70V step-up transformer. Digital Series Amplifier, part of the DS-DB system. See DN-60663.

**DS-RFM, DS-FM, DS-SFM:** Fiber conversion modules for DVC-EM, DS-DB distribution board, and DAX and DAA2 Series amplifiers. See DN-60633.

**DVC-AO:** DVC Analog Output board provides four analog output circuits for use with AA Series amplifiers. Four-channel operation supported. See DN-7045.

**DAA2-5025(E):** 50W, 25 Vrms Digital Audio Amplifier assembly with power supply; includes chassis. See DN-60556.

**DAA2-5070(E):** 50W, 70.7 Vrms Digital Audio Amplifier assembly with power supply; includes chassis. See DN-60556.

**DAA2-7525(E):** 75W, 25 Vrms digital audio amplifier assembly with power supply; includes chassis. See DN-60556.

**DAX-3525(E):** 35W, 25 Vrms Digital Audio Amplifier assembly with power supply, includes chassis. See DN-60561.

**DAX-3570(E):** 35W, 70.7 Vrms Digital Audio Amplifier assembly with power supply, includes chassis. See DN-60561.

**DAX-5025(E):** 50W, 25 Vrms Digital Audio Amplifier assembly with power supply, includes chassis. See DN-60561.

**DAX-5070(E):** 50W, 70.7 Vrms Digital Audio Amplifier assembly with power supply, includes chassis. See DN-60561.

**TELH-1:** Firefighter’s Telephone Handset for use with the DVC-EM when mounted in the CA-2 chassis. See DN-7045.

**CMIC-1:** Optional microphone and microphone well assembly used with the CA-1 chassis.

**RM-1/RM-1SA:** Remote microphone assemblies, mount on ADP-4 (RM-1) dress panel or CAB-RM/-RMR (RM-1SA) stand-alone cabinets. See DN-6728.

**AA-30:** Audio Amplifier, 30 watts, 25 Vrms. Includes amplifier and audio input supervision, backup input, and automatic switchover, power supply, cables. See DN-3224.

**AA-120/AA-100:** Audio Amplifier provides up to 120 watts of 25 VRMS audio power for the NFS-640. The amplifier contains an integral chassis for mounting to a CAB-B4, -C4, or -D4 backbox (consumes one row). Switch-mode power. Includes audio input and amplified output supervision, backup input, and automatic switchover to backup tone. Order the AA-100 for 70.7 VRMS systems and 100 watts of power. See DN-3224.

**DAA Series Digital Audio Amplifiers:** Legacy DAA Series amplifiers are compatible with DVC-EM systems running SR4.0. For specific information on DAA-50 series amplifiers, refer to DN-7046. For information on DAA-7525 Series, refer to DN-60257.

**NFC-25/50:** 25 watt, 25 VRMS, emergency Voice Evacuation Control Panel (VECP) with integral commercial microphone, digital message generator, and single-/dual-channel Class A or Class B speaker circuits. See DN-60772.

#### **COMPATIBLE DEVICES, EIA-232 PORTS**

**PRN-7:** 80-column printer. See DN-60897.

**VS4095/5:** Printer, 40-column, 24V. Mounted in external backbox. See DN-3260.

**DPI-232:** Direct Panel Interface, specialized modem for extending serial data links to remotely located FACPs and/or peripherals. See DN-6870.

#### **COMPATIBLE DEVICES, EIA-485 PORTS**

**ACM-24AT:** ONYX Series ACS annunciator – 24 points, expandable to 64 of annunciation with Alarm or Active LED, Trouble LED, and switch per circuit. Active/Alarm LEDs can be programmed (by powered-up switch selection) by point to be red, green, or yellow; the Trouble LED is always yellow. See DN-6862.

**AEM-24AT:** Same LED and switch capabilities as ACM-24AT, expands the ACM-24AT by 24 points or 36 points (with two modules). See *DN-6862*.

**ACM-48A:** ONYX Series ACS annunciator – 48 points, expandable to 64 of annunciation with Alarm or Active LED per circuit. Active/Alarm LEDs can be programmed (by powered-up switch selection) in groups of 24 to be red, green, or yellow. See *DN-6862*.

**AEM-48A:** Same LED capabilities as ACM-48A, expands the ACM-48A to 64 points. See *DN-6862*.

**ACM-8R:** Remote Relay Module with eight Form-C contacts. Can be located up to 6,000 ft. (1828.8 m) from panel on four wires. See *DN-3558*.

**FDU-80:** Terminal mode. 80-character, backlit LCD display. Mounts up to 6,000 ft. (1828.8 m) from panel. Up to 32 per FACP. See *DN-6820*.

**LCD2-80:** Terminal and ACS mode. 80-character, backlit LCD display. Mounts up to 6,000 ft. (1828.8 m) from panel. Up to 32 per FACP. See *DN-60548*.

**LDM:** Lamp Driver Modules LDM-32, LDM-E32, and LDM-R32; remote custom graphic driver modules. See *DN-0551*.

**SCS:** Smoke control stations SCS-8, SCE-8, with lamp drivers SCS-8L, SCE-8L; eight (expandable to 16) circuits (HVAC only). See *DN-4818*.

**TM-4:** Transmitter Module. Includes three reverse-polarity circuits and one municipal box circuit. Mounts in panel module position (single-address-style) or in CHS2-M2 position. See *DN-6860*.

**UDACT-2:** Universal Digital Alarm Communicator Transmitter, 636 channel. See *DN-60686*.

**UZC-256:** Programmable Universal Zone Coder provides positive non-interfering successive zone coding. Microprocessor-controlled, field-programmable from IBM®-compatible PCs (requires optional programming kit). Up to 256 programmable codes. Mounts in **BB-UZC** or other compatible chassis (purchased separately). See *DN-3404*.

#### COMPATIBLE INTELLIGENT DEVICES

NOTE: "A" suffix indicates ULC-Listed model.

**FWSG(A) Wireless SWIFT Gateway:** Addressable gateway supports wireless SLC devices. Order FWSGA for ULC applications. See *DN-60820*.

**FCO-951-IV** FlashScan, Addressable intelligent multi-criteria smoke sensors, photo, carbon monoxide, fixed temperature heat detector and infra-red (IR). ULC: FCO-951A-IV

**FPC-951.** FlashScan, Combined photoelectric and carbon monoxide sensor. ULC: FPC-951A.

**FSCO-951.** FlashScan, Addressable carbon monoxide sensor. ULC: FSCO-951A.

**FPTI-951, FPTI-951-IV:** Addressable intelligent multi-criteria photoelectric, thermal and IR sensors. ULC: FPTI-951A, FPTI-951A-IV.

**FS-OSI-RI** Addressable intelligent single-ended beam smoke detector. ULC: FS-OSI-RIA.

**FSP-951:** White, low-profile intelligent photoelectric sensor, FlashScan only. ULC: FSP-951A.

**FSP-951-IV:** Ivory, low-profile intelligent photoelectric sensor. ULC: FSP-951A-IV

**FSP-951T:** White, same as FSP-951 but includes a built-in 135°F (57°C) fixed-temperature thermal device. FlashScan only. ULC: FSP-951TA.

**FSP-951T-IV:** Ivory, same as FSP-951T but includes a built-in 135°F (57°C) fixed-temperature thermal device. ULC: FSP-951TA-IV.

**FSP-951R:** White, low-profile intelligent photoelectric sensor, remote test capable. For use with DNR/DNRW. FlashScan only. ULC: FSP-951RA

**FSP-951R-IV:** Ivory, low-profile intelligent photoelectric sensor, remote test capable. FlashScan only. ULC: FSP-951RA-IV, for use with DNRA.

**FST-951:** White, low-profile intelligent 135°F fixed thermal sensor, FlashScan only. Must be mounted to one of the bases listed below. ULC: FST-951A. See *DN-60975*.

**FST-951-IV:** Ivory, low-profile intelligent 135°F fixed thermal sensor, FlashScan and CLIP. Must be mounted to one of the bases listed below. ULC: FST-951A-IV.

**FST-951R:** White, low-profile intelligent rate-of-rise thermal sensor, FlashScan only. Must be mounted to one of the bases listed below. ULC: FST-951A

**FSP-951R-IV:** Ivory, low-profile intelligent photoelectric sensor, remote test capable. FlashScan only. ULC: FSP-951RA-IV, for use with DNRA.

**FST-951H:** White, low-profile intelligent 190°F fixed thermal sensor, FlashScan only. Must be mounted to one of the bases listed below. ULC: FST-951HA.

**FST-951H-IV:** Ivory, low-profile intelligent 190°F thermal sensor, FlashScan and CLIP. Must be mounted to one of the bases listed below. ULC: FST-951HA-IV.

**FSV-951, FSV-951R:** White, intelligent high-sensitivity photoelectric smoke detector. ULC: FSV-951A, FSV-951RA

**FSV-951-IV, FSV-951R-IV:** Ivory, intelligent high-sensitivity photoelectric smoke detector. ULC: FSV-951A-IV, FSV-951RA-IV.

**VEP-A00-P-NTF:** Intelligent aspiration smoke detector with LED display, 4 pipes, covers up to 21,520 square feet. See *DN-61029*. UL/ULC Listed.

**VEP-A10-P-NTF:** Intelligent aspiration smoke detector with LED and LCD display, 4 pipes, covers up to 21,520 square feet. See *DN-61029*. UL/ULC Listed.

**VEP-A00-1P-NTF:** Intelligent aspiration smoke detector with LED display, single pipe, covers up to 10,760 square feet. See *DN-61029*. UL/ULC Listed.

**VEU-A00-NTF:** Intelligent aspiration smoke detector with LED display, 4 pipes, covers up to 69,965 square feet. See *DN-61034*. UL/ULC Listed.

**VEU-A10-NTF:** Intelligent aspiration smoke detector with LED and LCD display, 4 pipes, covers up to 69,965 square feet. See *DN-61034*. UL/ULC Listed.

**VEA-040-A00-NTF:** Intelligent aspiration with LED display, 40 point-addressable detection points. Covers 36,000 square feet. See *DN-61036*. UL/ULC Listed.

**VEA-040-A10-NTF:** Intelligent aspiration with LED and LCD display, 40 point-addressable detection points. Covers 36,000 square feet. See *DN-61036*. UL/ULC Listed.

**VES-A00-P-NTF-UL:** Intelligent scanning aspiration detector with LEDs. See *DN-62040*. UL 268 7th edition.

**VES-A10-P-NTF-UL:** Intelligent scanning aspiration detector with 3.5" display. See *DN-62040*. UL 268 7th edition.

**DNR:** InnovairFlex low-flow non-relay duct-detector housing. ULC: DNRA. (Order FSP-951R(A) separately.) See *DN-60429*.

**DNRW:** Same as above with NEMA-4 rating, watertight. See *DN-60429*.

**B224RB-WH:** White, low-profile relay base. See *DN-60054*. ULC: B224RBA-WH.

**B224RB-IV:** Ivory, plug-in System Sensor relay base. ULC: B224RBA-IV.

**B224BI-WH:** White, isolator base for low-profile detectors. See *DN-60054*. ULC: B224BIA-WH.

**B224BI-IV:** Ivory isolator detector base. ULC: B224BIA-IV.

**B300-6:** White, standard flanged low-profile mounting base. (For 10-pack order B300-6-BP.) ULC: B300A-6.

**B300-6-IV:** Ivory, standard flanged low-profile mounting base. ULC: B300A-6-IV.

**B501-WHITE:** European-style, 4" (10.16 cm) base. See *DN-60054*. (For 10-pack order B501-WHITE-BP.) UL/ULC listed.

**B501-BL:** Black, 4" standard European flangeless mounting base. UL/ULC listed.

**B501-IV:** Ivory color, 4" standard European flangeless mounting base. UL/ULC listed.

**B200S-WH:** White, intelligent programmable sounder base, capable of producing a variety of tone patterns including ANSI Temporal 3. Compatible with synchronization protocol. See *DN-60054*. ULC: B200SA-WH.

**B200S-IV:** Ivory intelligent, programmable sounder base. ULC: B200SA-IV.

**B200SCOA-WH:** White intelligent, programmable sounder base in English/French (required in Canada for ULC applications with CO detectors. Based on B200SA. ULC listed.

**B200SCOA-IV:** Ivory intelligent, programmable sounder base in English/French (required in Canada for ULC applications with CO detectors. Based on B200SA. ULC listed.

**B200S-LF-WH:** White, low-frequency version of B200S. See *DN-60054*.

**B200S-LF-IV:** Ivory, low-frequency version of B200S.

**B200SR-WH:** White intelligent programmable sounder base, Temporal 3 or Continuous tone. For retrofit installations replacing B501BH series bases. See *DN-60054*. ULC: B200SRA-WH.

**B200SR-IV:** Ivory intelligent programmable sounder base, Temporal 3 or Continuous tone. For retrofit installations replacing B501BH series bases. ULC: B200SRA-IV.

**B200SR-LF-WH:** White, low-frequency version of B200SR. See *DN-60054*.

**B200SR-LF-IV:** Ivory, low-frequency version of B200SR.

**FMM-1(A):** FlashScan monitor module. See *DN-6720*.

**FDM-1(A):** FlashScan dual monitor module. See *DN-6720*.

**FZM-1(A):** FlashScan two-wire detector monitor module. See *DN-6720*.

**FMM-101(A):** FlashScan miniature monitor module. See *DN-6720*.

**FTM-1(A):** Firephone Telephone Module connects a remote firefighter telephone to a centralized telephone console. Reports status to panel. Wiring to jacks and handsets is supervised. See *DN-6989*.

**FCM-1(A):** FlashScan control module. See *DN-6720*.

**FCM-1-REL(A):** FlashScan releasing control module. See *DN-60390*.

**FRM-1(A):** FlashScan relay module. See *DN-6720*.

**FDRM-1(A):** FlashScan dual monitor/dual relay module. See *DN-60709*.

**NBG-12LX:** Manual pull station, addressable. See *DN-6726*.

**N-MPS series:** Manual pull stations, addressable and conventional. For use in Canada only. See *DN-5497* and *DN-60629*.

**ISO-X(A):** Isolator module. See *DN-2243*.

**ISO-6(A):** Six fault isolator module. See *DN-60844*.

**XP6-C(A):** FlashScan six-circuit supervised control module. See *DN-6924*.

**XP6-MA(A):** FlashScan six-zone interface module; connects intelligent alarm system to two-wire conventional detection zone. See *DN-6925*.

**XP6-R(A):** FlashScan six-relay (Form-C) control module. See *DN-6926*.

**XP10-M(A):** FlashScan ten-input monitor module. See *DN-6923*.

## **ENCLOSURES, CHASSIS, AND DRESS PLATES**

**CAB-4 Series Enclosure:** NFS2-640 mounts in a standard CAB-4 Series enclosure (available in four sizes, "A" through "D"). Backbox and door ordered separately; requires BP2-4 battery plate. A trim ring option is available for semi-flush mounting. See *DN-6857*.

**CAB-5 Series Enclosure:** NFS2-640 can mount in CAB-5 Series enclosures designed for INSPIRE panels, using CHS-ADP adapter plate. See *DN-62113* for *CAB-5 options*.

**EQ Series Cabinets:** EQ series cabinets will house amplifiers, power supplies, battery chargers and control modules. EQ cabinets are available in three sizes, "B" through "D". See *DN-60229*.

**CAB-BM Marine System:** Protects equipment in shipboard and waterfront applications. Also order **BB-MB** for systems using 100 AH batteries. For a full list of required and optional equipment, see *DN-60688*.

**CHS-4:** Chassis for mounting up to four APS-6Rs.

**CHS-4L:** Low-profile four-position Chassis. Mounts two AA-30 amplifiers or one AMG-E and one AA-30.

**DP-1B:** Blank dress panel. Provides dead-front panel for unused tiers; covers DAA2/DAX series or AA-series amplifier.

**NFS-LBB:** Battery Box (required for batteries larger than 26 AH).

**NFS-LBBR:** Same as above but red.

**CHS-BH1:** Battery chassis; holds two 12.0 AH batteries. Mounts one the left side of DAA2 chassis. See *DN-7046*.

**CA-1:** Chassis, occupies one tier of a CAB-4 Series enclosure. The left side accommodates one DVC-EM and a DVC-KD (optional); and the right side houses a CMIC-1 microphone and its well (optional). See *DN-7045*.

**CA-2:** Chassis assembly, occupies two tiers of a CAB-4 Series enclosure. The left side accommodates one DVC-EM mounted on a half-chassis and one NCA-2 mounted on a half-chassis. The right side houses a microphone/handset well. The CA-2 assembly includes CMIC-1 microphone. ADDR Series doors with two-tier visibility are available for use with the CA-2 configuration: ADDR-B4, ADDR-C4, ADDR-D4 (below).

**CFFT-1:** Chassis to mount firefighter's telephone and one ACS annunciator in a CAB-4 row. Includes TELH-1 firefighter's handset for the DVC-EM, chassis, phone well and mounting hardware. Order DP-CFFT dress panel separately.

**DP-CFFT:** CFFT-1 dress panel. Requires BMP-1 if no ACS annunciator is installed.

**ADDR-B4\*:** Two-tier-sized door designed for use with the CA-2 chassis configuration. ADDR Series doors are similar to CAB-4 Series "DR" doors, but a clear window space exposes the top two tiers of the CAB-4 enclosure. Use an SBB-B4 backbox with the ADDR-B4. See *DN-7045*, *DN-6857*.

**ADDR-C4\*:** Three-tier-sized door, designed for use with the CA-2 chassis configuration. ADDR Series doors are similar to CAB-4 Series "DR" doors, but a clear window space exposes the top two tiers of the CAB-4 enclosure. Use an SBB-C4 backbox with the ADDR-C4. See *DN-7045*, *DN-6857*.

**ADDR-D4\*:** Four-tier-sized door designed for use with the CA-2 chassis configuration. ADDR Series doors are similar to CAB-4 Series "DR" doors, but a clear window space exposes the top two tiers of the CAB-4 enclosure. Use an SBB-D4 backbox with the ADDR-D4. See *DN-7045*, *DN-6857*.

\* Note: Use ADDR-B4/C4/D4 when CA-2 chassis is installed in top two rows with NCA-2 or BP-CA2. Use standard door when CA-2 is not installed in top two rows. For additional configuration information, see the DVC application guide on <http://esd.notifier.com>.

**DPA-1:** Dress panel, used with the CA-1 chassis when configured with a DVC-EM, DVC-KD, and CMIC-1. See *DN-7045*.

**DPA-2B:** Dress panel used with CA-2 chassis assembly.

**VP-2B:** Dress panel, required when CA-2 chassis is installed in the top two cabinet rows.

**DPA-1A4:** Dress panel, used with the CA-1 chassis when the CMIC-1 is not used. Provides mounting options on right two bays for two ACS annunciators, or for blank plates. See *DN-7045*.

**BP-CA2:** Blank plate for CA-2 chassis.

**SEISKIT-CAB:** Seismic mounting kit. Required for seismic-certified applications with NFS2-640 and other equipment mounted in CAB-4 Series Enclosures. Includes battery bracket for two 26 AH batteries.

**SEISKIT-LBB:** Seismic kit for the NFS-LBB. Includes battery bracket for two 55 AH batteries.

#### **BACKBOXES**

NOTE: "C" suffix indicates ULC-Listed model.

**ABF-1B(C)** Annunciator Flush Box.

**ABF-1DB(C)** Annunciator Flush Box with Door.

**ABF-2B** Annunciator Flush Box

**ABF-2DB/C** Annunciator Flush Box with Door

**ABF-4B** Annunciator Flush Box

**ABS-1TB(C)** Annunciator Surface Box

**ABS-1B(C)** Annunciator Surface Box

**ABS-2B** Annunciator Surface Box

**ABS-2D(C)** Annunciator Surface Box

**ABS-4D(C)** Annunciator Surface Box

**BB-UZC:** Backbox for housing the UZC-256 in applications where the UZC-256 will not fit in panel enclosure. Black; for red, order BB-UZC-R.

#### **OTHER OPTIONS**

**CGW-MB:** CLSS Gateway for Internet/cloud-based communication between the FACP and peripheral devices. See *HON-62034*.

**HON-CGW-MBB:** CLSS Gateway, pre-installed in a cabinet. See *HON-62034*.

**411:** Slave digital alarm communicator. See DN-6619.

**411UDAC:** Digital alarm communicator. See DN-6746.

**IPDACT-2/2UD, IPDACT Internet Monitoring Module:** Connects to primary and secondary DACT telephone output ports for internet communications over customer-provided Ethernet connection. Requires compatible Teldat VisorALARM Central Station Receiver. Can use DHCP or static IP. See *DN-60408*.

**IPCHSKIT:** IP Communicator Chassis Mounting Kit. For mounting an IPDACT-2/2UD onto the panel chassis or CHS-4 series chassis. Use IPENC for external mounting applications.

**IPSPLT:** Y-adapter option allow connection of both panel dialer outputs to one IPDACT-2/2UD cable input.

**IPENC:** External enclosure for IPDACT, includes IPBRKT mounting bracket; Red. For Black order IPENC-B.

**HWF2V-COM:** LTE Digital Cellular Fire Alarm Communicator and Internet Panel, Verizon LTE / IP. Provides selectable configurable paths: cellular only, IP only, or IP primary with cellular backup. Connects to the primary and secondary ports of a DACT. See *DH-62010*. (For Canadian applications order IPGSM-4GC. See *DH-60771*.)

**HWF2A-COM:** LTE Digital Cellular Fire Alarm Communicator and Internet Panel, AT&T LTE / IP. Provides selectable configurable paths: cellular only, IP only, or IP primary with cellular backup. Connects to the primary and secondary ports of a DACT. (For Canadian applications order IPGSM-4GC. See *DH-60771*.)

**NOTE:** For other options including compatibility with retrofit equipment, refer to the panel's installation manual, the SLC manual, and the Device Compatibility Document.

## SPECIFICATIONS

### SYSTEM CAPACITY

- Intelligent Signaling Line Circuits ..... 1 expandable to 2
  - Intelligent detectors ..... 159 per loop
  - Addressable monitor/control modules ..... 159 per loop
  - Programmable software zones ..... 99
  - Special programming zones ..... 14
  - LCD annunciators per CPU2-640/-640E and NCA-2 (*observe power*) ..... 32
  - ACS annunciators per CPU2-640/-640E ..... 32 addresses x 64 points
  - ACS annunciators per NCA-2 ..... 32 addresses x 64 or 96 points
- NOTE:** The NCA-2 supports up to 96 annunciator address points per ACM-24AT/-48A.

### ELECTRICAL SPECIFICATIONS

- Primary input power:
    - CPU2-640 board: 120 VAC, 50/60 Hz, 5.0 A.
    - CPU2-640E board: 220/240 VAC, 50/60 Hz, 2.5 A.
  - Current draw (standby/alarm):
    - CPU2-640(E) board: 0.250 A. Add 0.035 A for each NAC in use.
    - KDM-R2: 0.100 A.
    - LEM-320: 0.100 A.
  - Total output 24 V power: 6.0 A in alarm.
- NOTE:** The power supply has a total of 6.0 A. of available power. This is shared by all internal circuits. See Installation Manual for a complete current draw calculation sheet.
- Standard notification circuits (4): 1.5 A each.
  - Resettable regulated 24V power: 1.25 A.
  - Two non-resettable regulated 24V power outputs:
    - 1.25 A.
    - 0.50 A.
  - Non-resettable 5V power: 0.15 A.
  - Battery charger range: 18 AH – 200 AH. Use separate cabinet for batteries over 26 AH.
  - Float rate: 27.6 V.

### CABINET SPECIFICATIONS

- Systems can be installed in CAB-4 Series cabinets (*four sizes with various door options, see DN-6857*). Requires BP2-4 Battery Plate.

### SHIPPING WEIGHT

- CPU2-640/-640: 14.3 lb (6.49 kg).
- CPU2-640/-640E: 14.55 lb (6.60 kg).

### TEMPERATURE AND HUMIDITY RANGES

This system meets NFPA requirements for operation at 0 – 49°C/32 – 120°F and at a relative humidity 93% ± 2% RH (noncondensing) at 32°C ± 2°C (90°F ± 3°F). However, the useful life of the system's standby batteries and the electronic components may be adversely affected by extreme temperature ranges and humidity. Therefore, it

is recommended that this system and its peripherals be installed in an environment with a normal room temperature of 15 – 27°C/60 – 80°F.

### AGENCY LISTINGS AND APPROVALS

The listings and approvals below apply to the basic NFS2-640 control panel. In some cases, certain modules may not be listed by certain approval agencies, or listing may be in process. Consult factory for latest listing status.

- **UL/ULC Listed:** S635.
- **FM Approved.**
- **Fire Dept. of New York:** #6212.
- **CSFM:** 7165-0028:0243.
- **City of Chicago.**
- **City and County of Denver.**
- **CCCF listed.**

**Marine Applications:** Marine approved systems must be configured using components itemized in this document. (See Main System Components, in "Product Line Information.") Specific connections and requirements for those components are described in the installation document, PN 54756. When these requirements are followed, systems are approved by the following agencies:

- **US Coast Guard** 161.002/50/0, 161.002/55/0 (Standard 46 CFR and 161.002).
- **Lloyd's Register** 11/600013 (ENV 3 category).
- **American Bureau of Shipping** (ABS) Type Approval.

**NOTE:** For information on marine applications, see DN-60688.

### STANDARDS

The NFS2-640 complies with the following UL Standards and NFPA 72, International Building Code (IBC), and California Building Code (CBC) Fire Alarm Systems requirements:

- **UL 864**, 10th edition (Control Units and Accessories for Fire Alarm Systems).
- **UL 2610** (Commercial Premises Security Alarm Units and Systems).
- **UL 2572** (Mass Notification Systems). (NFS2-640 version 20 or higher.)
- **ULC-S527-11** Standard for the Installation of Fire Alarm Systems.
- **LOCAL** (Automatic, Manual, Waterflow and Sprinkler Supervisory).
- **AUXILIARY** (Automatic, Manual and Waterflow) (requires TM-4).
- **REMOTE STATION** (Automatic, Manual, Waterflow and Sprinkler Supervisory) (requires TM-4).
- **PROPRIETARY** (Automatic, Manual and Waterflow).  
*Not applicable for FM.*
- **EMERGENCY VOICE/ALARM.**
- **OT, PSDN** (Other Technologies, Packet-switched Data Network).
- **IBC 2012, IBC 2009, IBC 2006, IBC 2003, IBC 2000** (Seismic).
- **CBC 2007** (Seismic).



This document is not intended to be used for installation purposes.  
We try to keep our product information up-to-date and accurate.  
We cannot cover all specific applications or anticipate all requirements.  
All specifications are subject to change without notice.

### NOTIFIER

12 Clintonville Road  
Northford, CT 06472  
203.484.7161  
www.notifier.com

NOTIFIRE<sup>®</sup>NET<sup>™</sup>, ONYXWorks<sup>™</sup>, and SWIFT<sup>™</sup> are all trademarks of and FlashScan<sup>®</sup>, NOTIFIER<sup>®</sup>, ONYX<sup>®</sup>, VeriFire<sup>®</sup> Tools, and VIEW<sup>®</sup> are all registered trademarks of Honeywell International Inc.  
©2022 by Honeywell International Inc. All rights reserved. Unauthorized use of this document is strictly prohibited.

Country of Origin: USA





**UOJZ.S635  
Control Units, System**

[Page Bottom](#)

**Control Units, System**

[See General Information for Control Units, System](#)

**NOTIFIER**

S635

12 Clintonville Rd  
Northford, CT 06472-1610 USA

Model	Control Unit System Type	Initiating Device Type (s)	Signaling Type(s)
<b>Control Unit</b>			
<b>Firewarden 100 (d)</b>	L	A, M, SS, WF	March, NC
	AUX	A, M, WF	NC
	RS (PPU)	A, M, SS, WF	C
	RS (PPU)	A, M, SS, WF	Rev Pol
	RS (PPU)	A, M, SS, WF	DAC, OT
	P (PPU)	A, M, SS, WF	C, DAC, OT
	CS (PPU)	A, M, SS, WF	DAC
<b>Firewarden-100-2 (d), Firewarden 100-2E (d)</b>	L	A, M, SS, WF	March, NC
	AUX	A, M, WF	NC
	RS (PPU)	A, M, SS, WF	C
	RS (PPU)	A, M, SS, WF	Rev Pol
	RS (PPU)	A, M, SS, WF	DAC, OT
	P (PPU)	A, M, SS, WF	C, DAC, OT
	CS (PPU)	A, M, SS, WF	DAC, OT
<b>FireWarden-50 (e), FireWarden-50E (e)</b>	L	A, M, SS, WF	C, March, NC
	AUX	A, M, WF	NC
	RS (PPU)	A, M, SS, WF	DAC, NC, OT, Rev Pol
	P (PPU)	A, M, SS, WF	C, DAC, OT
	CS (PPU)	A, M, SS, WF	DAC, OT
<b>NFS2-3030 #(f) (c), NFS2-3030E #(f) (c), XLS3000 #(f) (c)</b>	L	A, M, SS, WF	C, NC
	AUX	A, M, WF	NC
	RS (PPU)	A, M, SS, WF	DAC, OT, Rev Pol
	CS (PPU)	A, M, SS, WF	DAC, NC, OT
	P (PPU)	A, M, SS, WF	DAC, MX, NC, OT
<b>NCS5-W-ONYX, NCS5-F-ONYX</b>	CS, P (RU)	A, M, SS, WF	MX
<b>NFS2-640 (R) #(g) (c), NFS2-640E (R) (c) #(g), NFS-320 (R) #(g), NFS-320E/C (R) #(g) (c), NFS-320SYS(/E)(-FR) #(g)(c)</b>	L	A, M, SS, WF	C, MX, NC
	AUX	A, M, WF	NC

	RS (PPU)	A, M, SS, WF	DAC, OT, Rev Pol
	CS (PPU)	A, M, SS, WF	DAC, MX, NC, OT
	P (PPU)	A, M, SS, WF	DAC, MX, NC, OT
<b>NSP-25, NSP-25E</b>	AUX	A, M, WF	-
	L	A, M, SS, WF	C, NC
	RS (PPU)	A, M, SS, WF	DAC, OT, Rev Pol
	CS (PPU)	A, M, SS, WF	DAC, OT
<b>RP-1001*</b>	L	A, M, SS, WF	NC
	AUX	A, M, WF	NC
	RS (PPU)	A, M, WF	NC
	RS (PPU)	A, M, WF	DAC
	P (PPU)	A, M, WF	NC
	CS (PPU)	A, M, WF	DAC
<b>RP-1002*, RP-1002E*</b>	L	A, M, SS, WF	NC
	AUX	A, M, WF	NC
	RS (PPU)	A, M, WF	NC
	RS (PPU)	A, M, WF	DAC
	P (PPU)	A, M, WF	NC
	CS (PPU)	A, M, WF	DAC
<b>RP-2001 (2)(h), RP-2001E (2)(h), RP-2002 (2)(h), RP-2002E (2)(h)</b>	L	A, M, SS, WF	March, NC
	AUX	A, M, WF	NC
	RS (PPU)	A, M, SS, WF	DAC, NC, Rev Pol
	P (PPU)	A, M, WF	C, DAC
	CS (PPU)	A, M, SS, WF	DAC
<b>S5000 #(b)</b>	AUX, L, P (PPU), RS (PPU)	A, M, SS, WF	C, NC
	CS (PPU)	A, M, WF	C, DAC, NC
	CS, RS (PPU)	A, M, SS, WF	DAC
	RS (PPU)	SS	Rev Pol
<b>S5000E (b)</b>	CS (PPU)	A, M, WF	C, DAC, NC
	CS, RS (PPU)	A, M, SS, WF	DAC
	RS (PPU)	SS	Rev Pol
<b>SFP-2402 (a)</b>	L	A, M, SS, WF	March, NC
	P (PPU)	A, M, SS, WF	C
	CS (PPU)	A, M, SS, WF	DAC
<b>SFP-2402E (i), SFP-2404E (i)</b>	L	A, M, SS, WF	March, NC
	AUX	A, M, WF	NC
	P (PPU)	A, M, SS, WF	C
	CS (PPU)	A, M, SS, WF	DAC
<b>SFP-2404 (i)</b>	L	A, M, SS, WF	March, NC
	AUX	A, M, WF	NC
	RS (PPU)	A, M, SS, WF	Rev Pol
	P (PPU)	A, M, SS, WF	C
	CS (PPU)	A, M, SS, WF	DAC

<b>SFP-400*(j), SFP-400B*(j)</b>	L	A, M, SS, WF	NC
	AUX	A, M, WF	NC
	RS (PPU)	A, M, SS, WF	Rev Pol
	RS (PPU)	A, M, WF	DAC
	P (PPU)	A, M, WF	NC
	CS (PPU)	A, M, WF	DAC
<b>SFP-5UD (1)(h), SFP-10UD (1)(h), SFP-5UDE (1)(h), SFP-10UDE (1)(h), SFP-10UDC (1)(h), SFP-5UDC (1)(h)</b>			
	L	A, M, SS, WF	March, NC
	AUX	A, M, WF	NC
	RS (PPU)	A, M, SS, WF	DAC, NC, OT, Rev Pol
	CS (PPU)	A, M, SS, WF	DAC, OT
	P (PPU)	A, M, SS, WF	C, DAC, OT
<b>SGL-404</b>	CS (PPU)	A, M, WF	NC
	AUX, L	A, M, SS, WF	NC
	RS (PPU)	A, M, WF	NC
<b>XP Transponder #</b>	L	A, M, WF	NC
	AUX, P (PPU)	A, M, WF	MX, NC

**Control Unit Subassemblies - Intended for use with compatible control units as described in the control unit installation manual,**  
 Model(s) 4XLM LED interface module, 4XTM transmitter module, 4XZM zone relay module

**Enclosures,** Model(s) BB-100(++++)(k), BB-100R, BB-200(++++)(k), BB-200R

**Subassembly - Audio output board,** Model(s) DVC-AO

**Subassembly - Audio transformer,** Model(s) DS-XF70V

**Subassembly - Backup digital audio amplifier,** Model(s) BDA-25V, BDA-70V, DS-BDA

**Subassembly - Central processing unit board,** Model(s) CPU2-640, CPU2-640E

**Subassembly - CPU Board with display,** Model(s) CPU2-3030D

**Subassembly - CPU Board without display,** Model(s) CPU2-3030ND

**Subassembly - Digital Amplifier,** Model(s) DS-AMP/E

**Subassembly - Digital audio amplifiers,** Model(s) DAA-5025, DAA-5025E, DAA-5070, DAA-5070/E, DAA-5025EF, DAA-5025ESF, DAA-5025F, DAA-5025SF, DAA-5070F, DAA-5070SF, DAA-5070EF, DAA-5070ESF, DAA-7525F, DAA-7525SF, DAA2-5025, DAA2-5025E, DAA2-5070, DAA2-5070E, DAA2-7525, DAA2-7525E, DAX-3525, DAX-3525E, DAX-3570, DAX-3570E, DAX-5025, DAX-5025E, DAX-5070, DAX-5070E, DS-AMP, DS-AMPE

**Subassembly - Digital voice command,** Model(s) DVC, DVC-EM, DVC-EMF, DVC-EMSF

**Subassembly - Distribution board,** Model(s) DS-DB

**Subassembly - Fiber conversion module,** Model(s) DS-FM, DS-RFM, and DS-SFM

**Subassembly - Keypad board,** Model(s) DVC-KD

**Subassembly - Loop Control Module,** Model(s) LCM-320

**Subassembly - Loop Expander Module,** Model(s) LEM-320

**Subassembly - Microphone,** Model(s) CMIC-RP

**Subassembly - Network control module,** Model(s) NCM-F, NCM-W

**Subassembly - Power Supply,** Model(s) AMPS-24/E

**Subassembly - Power supply,** Model(s) DAA-PS, KAPS-24, KAPS-24E

**Subassembly - Remote paging unit,** Model(s) DVC-RPU

**Subassembly - Transmitter module,** Model(s) TM-4

**Supplementary Network Bridge,** Model(s) GW-WEBPORTAL, N-WEBPORTAL, SK-WEBPORTAL

L - Local System

A - Automatic Fire Alarm: thermostats, smoke detectors, etc.

M - Manual Fire Alarm: manually operated boxes

SS - Supervisory: gate valves, water-level switches, temperature switches, carbon monoxide alarm, residential fire alarm control units, etc.

WF - Waterflow Alarm: waterflow switches

March - March Time

NC - Noncoded, Steady, Temporal 3 Pattern, etc.

AUX - Auxiliary System

RS (PPU) - Remote Station System (Protected Premises Unit)

C - Coded

Rev Pol - Reverse Polarity

DAC - Digital Alarm Communicator

OT - Other Transmission Technologies

P (PPU) - Proprietary System (Protected Premises Unit)

CS (PPU) - Central Station System (Protected Premises Unit)

MX - Multiplex

CS - Central Station System

P (RU) - Proprietary System (Supervising Station Receiving Unit)

# - When Local (L) Type, System control unit with additional emergency voice communication, emergency telephone communication and paging.

(1) - Models are complementary Listed to FSZI, SYZV and QVAX.

(2) - Models are complementary Listed to FSZI, SYZV and QVAX when the System Type is Local.

(a) - When the Type Signaling is Coded (C) or Digital Alarm Communicator (DAC), see footnote +.

(b) - When Central Station (PPU) Type or Type Signaling is Digital Alarm Communicator (DAC), see footnote +.

(c) - When type signaling is OTHER TECHNOLOGIES, see footnote +

(d) - When Type Signaling is Digital Alarm Communicator (DAC), Coded (C) or Other Technologies (OT) see footnote +. When Type Signaling is Reverse Polarity - requires separately Listed Model 4XTMF transmitter module.

(e) - Noncoded (NC) or Coded (C) Type Signaling (except when Type is Local (L) Rev. Pol. Type Signaling, see footnote +.

(f) - When Type Signaling is Coded (C), Digital Alarm Communicator (DAC) or Reverse Polarity, see footnote +.

(g) - When Type Signaling is Coded (C), see footnote +.

(h) - When Type is Auxiliary or Type Signaling is Reverse Polarity- requires separately Listed Model 4XTMF transmitter Module. When the Type is any Protected Premises Unit (PPU) and the Type Signaling is Coded (C), Non Coded (NC) or Digital Alarm Communicator (DAC), see footnote +.

(i) - When the Type is Auxiliary or the Type Signaling is Coded (C) or Digital Alarm Communicator (DAC), see footnote +.

(j) - When Type Signaling is Reverse Polarity, see footnote +.

(k) - Note (+++++) - May include /R suffix.

\* - Protected Premises Unit when installed and interconnected with additional Listed equipment as described in the units installation instructions.

+ - Must be employed with additional specific Listed device(s) as indicated in installation instructions and wiring diagrams to provide indicated type service. The installation instructions for the Other Transmission Technologies transmitter will specify the compatible Notifier control unit model.

Last Updated on 2016-01-20

[Questions?](#)

[Print this page](#)

[Terms of Use](#)

[Page Top](#)

© 2016 UL LLC

The appearance of a company's name or product in this database does not in itself assure that products so identified have been manufactured under UL's Follow-Up Service. Only those products bearing the UL Mark should be considered to be Certified and covered under UL's Follow-Up Service. Always look for the Mark on the product.

UL permits the reproduction of the material contained in the Online Certification Directory subject to the following conditions: 1. The Guide Information, Assemblies, Constructions, Designs, Systems, and/or Certifications (files) must be presented in their entirety and in a non-misleading manner, without any manipulation of the data (or drawings). 2. The statement "Reprinted from the Online Certifications Directory with permission from UL" must appear adjacent to the extracted material. In addition, the reprinted material must include a copyright notice in the following format: "© 2016 UL LLC".

# HPF-PS6/HPF-PS10 Series 6/10 Amp, 24 Volt Power Supplies

## General

The HPF-PS Series is a remote power supply line from Honeywell and is a direct replacement for the PSE and FCPS Series. The HPF-PS6(B)(E) is a 6 amp and the HPF-PS10(B)(E) is a 10 amp, remote power supply with battery charger that may be connected to any 12 or 24 volt fire alarm control panel (FACP) or used as a stand-alone power supply. The HPF-PS Series provides 24 VDC power for NACs (notification appliance circuits) configured as either Class B or Class A (requires the ZNAC-PS option card) with multiple sync protocol options. The HPF-PS Series also provides auxiliary power, constant or resettable, suited for detectors, annunciators, door holders, and other fire alarm system peripherals. The HPF-PS Series cabinet can hold two 7 AH or 18 AH batteries and can charge up to 33 AH batteries in a separate cabinet. The HPF-PS6E and HPF-PS10E are models rated for 240V operation.

## Features

- Up to five (6 amp model) or seven (10 amp model) independently-configurable, power-limited output circuits for:
  - Class B and/or Class A NACs
  - Class B and/or Class A resettable or non-resettable 24V auxiliary power
  - door holder power
- Converts from Class B to Class A wiring without losing any outputs using the ZNAC-PS converter card (sold separately)
- Optimal for powering four-wire smoke detectors, annunciators, and other system peripherals requiring regulated power
- Configurable for ANSI® Temporal 3 or Temporal 4 coded output
- UL-Listed NAC synchronization using System Sensor®, Wheelock®, Gentex®, or AMSECO® appliances
- Synchronization can be triggered from FACP NAC/remote sync outputs, cascaded power supply, or a control module, single or multi, which may be housed within the power supply cabinet
- Ability to cascade up to four power supplies
- Two (6 amp model) or three (10 amp model) fully-isolated input/control circuits which can be programmed to any output
- Two Form C normally-closed trouble relays for AC Trouble and General Trouble, Ground Fault relay available on Canadian models only
- 6 or 10 amp full load output, respectively, with 3 A maximum/circuit
- Individual NAC power and trouble LEDs for diagnostic efficiency
- Trouble history modes for diagnostic support
- Wide range end-of-line supervision value (normal: 2K-27K ohms)
- Selectable earth fault detection (enable or disable)
- AC trouble report delay timer
- Completely configurable via onboard DIP switches, no extra software required
- Self-contained in compact, locking cabinet constructed of heavy gauge steel with a corrosion-resistant powder coat chip and scratch-resistant finish
- Cabinet designed with ten double knockouts and a removable door for ease of installation and wiring
- Includes integral battery charger capable of charging up to 33 AH batteries
- Cabinet can house two 7 AH or 18 AH batteries



- Battery charger may be disabled via DIP switch for applications requiring larger batteries and external battery charger
- Removable terminal blocks accommodate up to 12 AWG (3.1mm<sup>2</sup>) wire
- Works with any UL 864 FACP which utilizes an industry-standard reverse-polarity notification circuit
- Optional devices include addressable control, monitor, and relay modules and power-supervision relay (EOLR-1)

## Standards and Codes

The HPF-PS Series comply with the following standards:

- **NFPA 72** National Fire Alarm Code
- **UL 864** Standard for Control Units for Fire Alarm Systems (NAC expander mode), 10th Edition
- **UL 1481** Power Supplies for Fire Alarm Systems
- **IBC 2009** (when using SEISKIT-MULTI-1)
- **CBC 2007** (when using SEISKIT-MULTI-1)

## Agency Listings and Approvals

These listings and approvals apply to the modules specified in this document. In some cases, certain modules or applications may not be listed by certain approval agencies, or listing may be in process. Consult factory for latest listing status.

- **UL Listed:** S24562 (HPF-PS/E Series), S635, S674 (PSE Series, discontinued)
- **ULC Listed:** S24562 (HPF-PS Series), S635 (PSE-6C/PSE-10C discontinued)
- **CSFM Approved:** 7315-1637:0505 (HPF-PS Series), 7315-0028:0513 (PSE Series, discontinued)
- **FDNY COA:** 2022-TMCOAP-002231-AMND (HPF-PS Series), 2021-TMCOAP-001761-CERT (PSE Series, discontinued)
- **FM Approved**

## SPECIFICATIONS

### Primary (AC) Power:

- **HPF-PS6(B):** 120 VAC, 50/60 Hz, 5.0A maximum
- **HPF-PS10(B):** 120VAC, 50/60 Hz, 6.2 A maximum
- **HPF-PS6E:** 240 VAC, 50/60 Hz, 2.7A maximum
- **HPF-PS10E:** 240 VAC, 50/60 Hz, 3.5A maximum
- **Wire Size:** #12-14 AWG with 600 V insulation

### Command Input Circuit:

- **Trigger Input Voltage:** 9 to 32 VDC
- **Trigger Current:** 2.0 mA (16 - 32 V); Per Input: 1.0 mA (9 - 16 V)

### Trouble Contact Rating:

 4 A at 24 VDC

### Output Circuits:

- 24 VDC filtered, regulated
- HPF-PS6(B): TB8-TB9 – 1A Regulated, 3A special applications; TB10-TB12 – 0.3A Regulated, 3A special applications
- HPF-PS10(B): TB8-TB11 – 1.5A Regulated, 3A special applications; TB12-TB14 – 0.3A Regulated, 3A special applications
- 6.0 A (HPF-PS6) or 10.0 A (HPF-PS10) maximum total continuous current for all outputs

### Secondary Power (Battery) Charging Circuit:

- Supports lead-acid batteries only
- Float-charge voltage: 27.6 VDC
- Maximum current charge: 1.5 A
- Maximum battery capacity: 18 AH (inside cabinet)
- Maximum battery charging capacity: 33 AH (external cabinet)

### Physical:

- **Dimensions:** 20.0"H x 14.5"W x 3.5"D (cm: 50.8H x 36.83W x 8.9D)
- **Weight:** with two 7Ah batteries is 24 pounds (10.9 kg), with two 18 AH batteries is 39 pounds (17.7 kg)

## Ordering Information

**HPF-PS6:** 6.0 A, 120 VAC remote charger power supply in a lockable, metal enclosure, red

**HPF-PS6B:** 6.0 A, 120 VAC remote charger power supply in a lockable, metal enclosure, black

**HPF-PS6E:** 6.0 A, 240 VAC remote charger power supply in a lockable, metal enclosure, red

**HPF-PS10:** 10.0 A, 120 VAC remote charger power supply in a lockable, metal enclosure, red

**HPF-PS10B:** 10.0 A, 120 VAC remote charger power supply in a lockable, metal enclosure, black

**HPF-PS10E:** 10.0 A, 240 VAC remote charger power supply in a lockable, metal enclosure, red

**ZNAC-PS:** Optional Class A output converter module

**50152254-001:** Hardware kit for Canadian applications

**17045:** Alternate NOTIFIER lock set

**FCM-1:** Addressable Control Module for one Class B or Class A zone of supervised, polarized Notification Appliances. Notification Appliance Circuit option requires external 24 VDC to power notification appliances.

**FRM-1:** Addressable relay module containing two isolated sets of Form-C contacts, which operate as a DPDT switch

**FMM-1:** Addressable Monitor Module for one zone of normally open dry-contact initiating devices. Includes plastic cover plate and end-of-line resistor. Module may be configured for either a Class B or Class A IDC.

**FDM-1:** Dual Monitor Module. Same as FMM-1 except it provides two inputs for Class B wiring only

**FDRM-1:** Provides two monitored inputs and two Form-C relays. Functions in Class B wiring only.

**XP6-C:** Six-circuit supervised control module

**XP6-R:** Six Form-C relay control module

**EOLR-1:** 12/24 VDC end-of-line relay for monitoring four-wire smoke detector power

**BAT-1270-BP:** Battery, 12 volt, 7.0 AH, 5-pack (two required, see BAT Series data sheet DN-6933).

**BAT-12180-BP:** Battery, 12 volt, 18AH, 2-pack

**BAT-12330:** Battery, 12 volt, 33AH

**SEISKIT-MULTI-1:** Seismic kit for the HPF-PS Series. Includes bracket and hardware for two 7AH or two 18AH batteries.



This document is not intended to be used for installation purposes.

We try to keep our product information up-to-date and accurate.

We cannot cover all specific applications or anticipate all requirements.

All specifications are subject to change without notice.

NOTIFIER® and System Sensor® are registered trademarks of Honeywell International, Inc. Wheelock® is a registered trademark of Cooper Technologies Company. Gentex® is a registered trademark of Gentex Corporation. AMSECO® is a registered trademark of Potter Electric Signal Company, LLC. ANSI® is a registered trademark of the American National Standards Institute, Inc.

©2023 by Honeywell International Inc. All rights reserved. Unauthorized use of this document is strictly prohibited.

Country of Origin: USA

## NOTIFIER

12 Clintonville Road  
Northford, CT 06472  
203.484.7161  
www.notifier.com



# DVC Series

## Digital Voice Command DVC-EM, DVC-EMF, DVC-EMSF



Voice Control Systems

### General

The DVC is the heart of an integrated, full-featured Audio Command Center. The DVC Digital Voice Command combines the capabilities of a powerful digital audio processor, an event-driven audio message generator, and a router. Designed for use with Digital Audio Loop (DAL) devices such as DAA2, DAX and DAA series digital amplifiers, each DVC supports a dedicated audio network with up to eight channels of audio, five channels of firefighter telephone communications, and control and supervision for up to 32 DAL devices. DVCs are available in versions supporting wire, multi-mode fiber, or single-mode fiber media. Larger audio systems incorporating hundreds of amplifiers can be created by networking additional DVC units via **NOTI•FIRE•NET™**.

The DVC may be networked with ONYX® Series panels via **NOTI•FIRE•NET** with an NCA-2, or with an NFS2-3030 (running in network monitor mode). A DVC can be connected directly with a single NFS2-640 or NFS2-3030 Fire Alarm Control Panel (FACP) to create a standalone integrated audio solution as well. Refer to the DVC manual for details.

When used as an Audio Command Center with Emergency Paging capability, the optional DVC-KD Keypad Display is required.

**NOTE:** Unless otherwise noted, the term “DVC” refers to the DVC-EM, DVC-EMF, and DVC-EMSF models.

### Features

- Listed to UL Standard 864, 9th edition.
- Programmable from NUP port using *VeriFire® Tools* with:
  - DVC-EM: up to 32 minutes of standard quality or 4 minutes of high quality digital audio storage of user-selected/created messages and tones. Supports twisted-pair wire media.
  - DVC-EMF: Same as DVC-EM, except supports multi-mode fiber-optic media.
  - DVC-EMSF: Same as DVC-EM, except supports single-mode fiber-optic media.
- Up to 1000 audio sequences.
- Message prioritization.
- Equations support flexible programming for distribution of messages.
- Electrically isolated digital audio ports for direct connection with up to 32 Digital Audio Loop (DAL) devices. Style 4 or 7 configurations supported.
- DCC (Display and Control Center) capabilities when used with optional DVC-KD.
- Firefighters’ Telephone Communications to local FFT riser on DVC, 32 local DAL device FFT risers, and FFT communication to additional command stations via **NOTI•FIRE•NET™**.
- Local paging microphone option.
- Remote microphone option.
- Broad All-Call functionality when used with DVC-KD (DVC-Keyboard Display): All Call, Page Active Evac Areas, Page Active Alert Areas, Page Inactive Areas.



**DVC**  
Shown using CA-2 mounting option,  
SBB-C4, and ADDR-C4 door.

- Auxiliary input for 12 V<sub>p-p</sub> analog low-level audio sources. Includes user audio level adjustment feature.
- Auxiliary input accepts external audio sources such as telephone paging or background music. High impedance input accepts 600 ohm, line level, 1.0 VRMS, or 1.41 V<sub>p-p</sub> low level audio. Selectable AGC, user control of audio level, and audio supervision are supported.
- Associated NCA-2, or NFS2-3030 (programmed for network monitor mode) supports **NOTI•FIRE•NET** applications.
- Multiple audio command centers supported via **NOTI•FIRE•NET**.
- Distribution of one channel of standard-level paging audio on **NOTI•FIRE•NET**.
- Three standalone, non-network mode options:
  - NFS2-3030 (NUP to NUP) digital and analog.
  - NFS2-640 (NUP to NUP) analog audio only.
  - NFS2-640 with NCA-2 (NUP to NUP to NUP) digital and analog.
- Push-to-talk relay, or logic argument.
- Isolated alarm bus input, to be used for backup activation of alarm messages when normal digital communication is lost.

### Installation Options

The DVC provides flexible configurations based on one-row or two-row chassis options that mount into size “B”, “C”, or “D” CAB-4 Series cabinets.

The CA-2 supports a DVC, paging microphone, optional FFT telephone, and mounting location for an NCA-2 or NFS2-3030D CPU. The ADDR audio door series can be used when a CA-2 is mounted in the top two rows. The CA-1 supports a DVC and an optional microphone in a single row. For firefight-

ers' telephone applications with a CA-1, the CFFT-1 can be mounted in the row below the CA-1.

**NOTE:** For NFS2-640/DVC applications using DAL devices, an NCA-2 is required to announce DAL device events. Refer to the DVC System Audio Product Application Guide (part number M-AG-DVC) for more details on DVC applications).

## Specifications

- **24 VDC power (TB1):** 24 VDC, 1.0 A, non-resettable, power-limited by the source. Recommended wiring: 14 to 18 AWG (2.08 to 0.821 mm<sup>2</sup>) twisted-pair.
- **Digital audio ports, wire media, A and B (TB2, TB3):** Maximum distance per segment is 1900 feet (579.12 m) on Belden 5320UJ (18 AWG, TP) FPL cable: 18 AWG (0.821 mm<sup>2</sup>) twisted-pair, foil-shielded, power-limited. Consult wiring documentation provided in document P/N 52916ADD:C *Addendum to DVC and DAA Manuals*.
- **Digital audio ports, single- and multi-mode fiber-optic RXA, TXA, RXB, and TXB (J100, J101, J102, and J103):** ST® style, supervised. Multi-mode fiber-optic cable: 50/125 or 62.5/125 micrometers. Single-mode fiber-optic cable: 9/125 micrometers. Attenuation of cabling between two nodes (fiber-optic circuits are point-to-point) must not exceed the following maximum attenuations: 4.2 dB for multi-mode with 50/125 micrometer cable @ 850 nm. 8.0 dB for multi-mode with 62.5/125 micrometer cable @ 850 nm. 5.0 dB for single-mode with 9/125 micrometer cable @ 1300 nm.
- **Auxiliary input A (AUX A, TB4):** Signal strength from low-level analog audio input: maximum 1.0 VRMS, or 1.41 V<sub>p-p</sub>. Optional supervision is selectable through programming. Recommended wiring: 18 AWG (0.821 mm<sup>2</sup>) twisted-pair; max. 14 AWG (2.08 mm<sup>2</sup>). Auxiliary input must be in the same room as the DVC.
- **Auxiliary input B (AUX B, TB14):** Signal strength from low-level analog audio input: 12 V<sub>p-p</sub> nominal, 15 V<sub>p-p</sub> maximum. Optional supervision is selected through programming. Recommended wiring: 14 to 18 AWG (2.08 to 0.821 mm<sup>2</sup>) twisted-pair.
- **Remote microphone interface (TB9):** Recommended wiring: 14 to 18 AWG (2.08 to 0.821 mm<sup>2</sup>) twisted-pair. Power-limited. Maximum distance between remote microphone and DVC: 1000 feet (300 m).
- **Push-to-talk interface (TB10):** Dry contact. Recommended wiring: 14 to 18 AWG (2.08 to 0.821 mm<sup>2</sup>) twisted-pair.
- **Alarm bus (TB12):** Power-limited by source. Recommended wiring: 14 to 18 AWG (2.08 to 0.821 mm<sup>2</sup>) twisted-pair.
- **FFT riser (TB13):** Power-limited output. Class A (Style Z) or Class B (Style Y) operation. Style Y two-wire connections require a 3.9K ohm, 1/2 watt resistor (P/N K-3.9K). Maximum wiring resistance (including individual telephone zone to last handset) permitted is 50 ohms, 10,000 feet (3048 m) maximum wiring distance at 12 AWG (3.31 mm<sup>2</sup>) to last handset.
- **Optional DVC-AO analog audio output circuits (TB5, TB6, TB7, and TB8):** Supervised, power-limited outputs. Signal strength: +12 V<sub>p-p</sub> nominal, +15 V<sub>p-p</sub> maximum. Recommended wiring: 18 AWG (0.821 mm<sup>2</sup>) twisted-pair; max. 14 AWG (2.08 mm<sup>2</sup>). Maximum impedance: 66 ohms.

## Standards and Codes

The Digital Voice Command DVC, DVC-EM, DVC-EMF, and DVC-EMSF comply with the following standards:

- NFPA 72 2002 National Fire Alarm Code.
- Underwriters Laboratories Standard UL 864, 9th edition.
- Underwriters Laboratories of Canada (ULC) ULC-S527-99 Standard of Control Units for Fire Alarm Systems.

## Listings and Approvals

The listings and approvals below apply to the DVC, DVC-EM, DVC-EMF, and DVC-EMSF Digital Voice Command. In some cases, certain modules may not be listed by certain approval agencies, or listing may be in process. Consult factory for latest listing status.

- **UL Listed:** file S635.
- **ULC Listed:** file S635.

The DVC is approved by the following agencies except for use with a DAA2 or DAX Series amplifier, or DS-FM Series fiber conversion module:

- **FM Approved.**
- **CSFM approved:** file 7165-0028:224 (NFS2-3030); 7165-0028:243 (NFS2-640).
- **FDNY:** COA#6026 (NFS2-3030); COA#6025 (NFS2-640).
- **City of Chicago approved:** High Rise, Class 1, Class 2 (NFS2-3030, NFS2-640, NCA-2).
- **City of Denver approved** (NFS2-3030).
- **PSB Corporation approved** (*Singapore*) (NFS2-3030).

## Product Line Information

**DVC-EM:** Digital Voice Command, digital audio processor with message storage for up to 32 minutes of standard quality (4 minutes at high quality) digital audio. *Supports twisted-pair wire media.*

**DVC-EMF:** Digital Voice Command, digital audio processor with message storage for up to 32 minutes of standard quality (4 minutes at high quality) digital audio. *Supports multi-mode fiber-optic ports, requires DAA-5025F, or DAA-5070F, or DAA-7525F.*

**DVC-EMSF:** Digital Voice Command, digital audio processor with message storage for up to 32 minutes of standard quality (4 minutes at high quality) digital audio. *Supports single-mode fiber-optic ports, requires DAA-5025SF, DAA-5070SF, or DAA-7525F.*

**DVC-KD:** Keypad for local annunciation and controls; status LEDs and 24 user-programmable buttons.

**DVC-AO:** Optional DVC Analog Output board provides four analog output circuits for use with AA or XPIQ Series amplifiers. Four-channel operation supported.

**CA-1:** Chassis, occupies one tier of a CAB-4 Series enclosure. The left side accommodates one DVC and a DVC-KD (optional); and the right side houses a CMIC-1 microphone and its well (optional).

**CMIC-1:** Optional microphone and microphone well assembly used with the CA-1 chassis.

**CFFT-1:** The CFFT-1 Chassis for Firefighters' Telephone mounts in the row directly under a DVC that is mounted in a CA-1 single row chassis. The CFFT-1 includes one FFT handset. The DP-CFFT Dress Plate (separately ordered, required) has one open position for mounting an ACS annunciator or a BMP-1 Blank Module Plate.

**CA-2:** Chassis assembly, occupies two tiers of a CAB-4 Series enclosure. The left side accommodates one DVC mounted on

a half-chassis and one NFS2-3030 or NCA-2 mounted on a half-chassis. The right side houses a microphone/handset well. The CA-2 assembly includes a microphone. DPA-2B dress plate is required (*below*); the VP-2B Vent Plate is also required for top row configurations. ADDR Series doors with two-tier visibility are available for use with the CA-2 configuration: ADDR-B4, ADDR-C4, ADDR-D4 (*below*).

**DPA-2B:** Dress plate required for CA-2 chassis assembly.

**VP-2B:** Vent plate required for cabinet configurations where the DPA-2B is used for the top two row position.

**TELH-1:** Firefighters' Telephone Handset for use with the DVC when mounted in the CA-2 chassis. Order separately.

**ADDR-B4:** Two-tier-sized door designed for use with a CA-2 chassis mounted in the top rows. ADDR Series doors are similar to CAB-4 Series "DR" doors, but a clear window space exposes the top two tiers of the CAB-4 enclosure. Use an SBB-B4 backbox with the ADDR-B4 (*see data sheet DN-6857*).

**ADDR-C4:** Three-tier-sized door designed for use with a CA-2 chassis mounted in the top rows. ADDR Series doors are similar to CAB-4 Series "DR" doors, but a clear window space exposes the top two tiers of the CAB-4 enclosure. Use an SBB-C4 backbox with the ADDR-C4 (*see data sheet DN-6857*).

**ADDR-D4:** Four-tier-sized door designed for use with a CA-2 chassis mounted in the top rows. ADDR Series doors are similar to CAB-4 Series "DR" doors, but a clear window space exposes the top two tiers of the CAB-4 enclosure. Use an SBB-D4 backbox with the ADDR-D4 (*see data sheet DN-6857*).

**DPA-1:** Dress panel, can be used with the CA-1 chassis when configured with a DVC, DVC-KD, and CMIC-1.

**DPA-1A4:** Dress panel, used with the CA-1 chassis when the CMIC-1 is not used. Provides mounting options on right two bays for two ACS annunciators, or for blank plates.

**ACT-4:** Audio-coupling transformer. Used to electronically isolate DVC-AO analog risers.

**ACT-25, ACT-70:** Audio-coupling transformers for 25V and 70V high-level audio. Used to isolate and convert high-level audio to low-level, supporting applications with large numbers of analog amplifiers.

**DAX-3525(E)/DAX-3570(E):** 35W, 25 or 70.7VRMS. Digital audio amplifiers with charging power supply and 2 Class B or 1 Class A output, shipped mounted on chassis. Options: BDA-25/70 backup amplifier, DS Fiber modules.

**DAX-5025(E)/DAX-5070(E):** 50W, 25 or 70.7VRMS. Digital audio amplifiers with power supply and 2 Class B or 1 Class A output, shipped mounted on chassis. Options: BDA-25/70 backup amplifier, DS Fiber modules.

**DAA2-5025(E)/DAA2-5070(E):** 50W, 25 or 70.7VRMS. Digital audio amplifiers with charging power supply and 4 Class B or 2 Class A outputs, shipped mounted on chassis. RM-1 port, FFT port, Aux audio port. Supports optional BDA for backup amplifier or 2-channel operation, and DS Fiber modules.

**DAA2-7525(E):** 75W, 25VRMS. Digital audio amplifiers with power supply and 4 Class B or 2 Class A outputs, shipped mounted on chassis. RM-1 port, FFT port, Aux audio port. Supports optional BDA for backup amplifier or 2-channel operation, and DS Fiber modules.

**BDA-25, BDA-70:** Backup Digital Amplifier, 25 or 70.7VRMS, can be configured to act as a one-to-one backup for DAX and DAA2 series amplifiers. For DAA2 Series only, supports alternative second channel operation.

**DS-RFM, DS-FM, DS-SFM:** Fiber conversion modules for DAX and DAA2 Series amplifiers.

**DAA Series Digital Audio Amplifiers:** Legacy DAA Series amplifiers are compatible with DVC systems running SR4.0. For specific information on DAA-50 series amplifiers, refer to DN-7046. For information on DAA-7525 Series, refer to DN-60257.

- **DAA-5025:** 50W, 25Vrms Digital Audio Amplifier assembly with DAA-PS power supply board, shipped mounted to its chassis. Supports twisted-pair wire media. See DN-7046. (*For multi-mode fiber-optic media order DAA-5025F. For single-mode fiber-optic media order DAA-5025SF.*)

- **DAA-5070:** 50W, 70.7Vrms Digital Audio Amplifier assembly with DAA-PS power supply board, shipped mounted to its chassis. Supports twisted-pair wire media. See DN-7046. (*For multi-mode fiber-optic media order DAA-5070F. For single-mode fiber-optic media order DAA-5070SF.*)

- **DAA-7525:** 75W, 25Vrms Digital Audio Amplifier assembly with DAA-PS power supply board. Shipped mounted to its chassis (no battery charger on DAA-7525 power supply board). Supports twisted-pair wire media. See DN-60257. (*For multi-mode fiber-optic media order DAA-7525F. For single-mode fiber-optic media order DAA-7525SF.*)

---

ONYX®, NOTIFIER®, and VeriFire® are registered trademarks and NOTI•FIRE•NET™ is a trademark of Honeywell International Inc. ST® is a registered trademark of AT&T.  
©2010 by Honeywell International Inc. All rights reserved. Unauthorized use of this document is strictly prohibited.



This document is not intended to be used for installation purposes.  
We try to keep our product information up-to-date and accurate.  
We cannot cover all specific applications or anticipate all requirements.  
All specifications are subject to change without notice.



Made in the U.S. A.

For more information, contact Notifier. Phone: (203) 484-7161, FAX: (203) 484-7118.  
[www.notifier.com](http://www.notifier.com)

**UOJZ.S635**  
**Control Units, System**
[Page Bottom](#)
**Control Units, System**
[See General Information for Control Units, System](#)
**NOTIFIER**

S635

 12 CLINTONVILLE RD  
 NORTHFORD, CT 06472 USA

Model	Type Fire Alarm	Type Service	Type Signaling
<b>Control Unit</b>			
NFS2-3030 # (f) (c), NFS2-3030E # (f) (c), XLS3000 # (f) (c)	L	A, M, SS, WF	C, NC
	AUX	A, M, WF	NC
	RS (PPU)	A, M, SS, WF	DAC, OT, Rev Pol
	CS (PPU)	A, M, SS, WF	DAC, NC, OT
	P (PPU)	A, M, SS, WF	DAC, MX, NC, OT
Firewarden 100 (d), Firewarden-100-2 (d), Firewarden 100-2E (d)	L	A, M, SS, WF	March, NC
	AUX	A, M, WF	NC
	RS (PPU)	A, M, SS, WF	C
	RS (PPU)	A, M, SS, WF	Rev Pol
	RS (PPU)	A, M, SS, WF	DAC, OT
	P (PPU)	A, M, SS, WF	C, DAC, OT
FireWarden-50 (e), FireWarden-50E(e)	L	A, M, SS, WF	C, March, NC
	AUX	A, M, WF	NC
	RS (PPU)	A, M, SS, WF	DAC, NC, OT, Rev Pol
	P (PPU)	A, M, SS, WF	C, DAC, OT
	CS (PPU)	A, M, SS, WF	DAC, OT
NCS5-W-ONYX, NCS5-F-ONYX	CS, P (RU)	A, M, SS, WF	MX
NFS2-640 (R) # (g) (c), NFS2-640E (R) (c) # (g), NFS-320 (R) # (g), NFS-320E/C (R) # (g) (c), NFS-320SYS (/E)(-FR) # (g)(c)			

	L	A, M, SS, WF	C, MX, NC
	AUX	A, M, WF	NC
	RS (PPU)	A, M, SS, WF	DAC, OT, Rev Pol
	CS (PPU)	A, M, SS, WF	DAC, MX, NC, OT
	P (PPU)	A, M, SS, WF	DAC, MX, NC, OT
<b>NSP-25, NSP-25E</b>	AUX	A, M, WF	-
	L	A, M, SS, WF	C, NC
	RS (PPU)	A, M, SS, WF	DAC, OT, Rev Pol
	CS (PPU)	A, M, SS, WF	DAC, OT
<b>RP-1001*</b>	L	A, M, SS, WF	NC
	AUX	A, M, WF	NC
	RS (PPU)	A, M, WF	NC
	RS (PPU)	A, M, WF	DAC
	P (PPU)	A, M, WF	NC
	CS (PPU)	A, M, WF	DAC
<b>RP-1002*, RP-1002E*</b>	L	A, M, SS, WF	NC
	AUX	A, M, WF	NC
	RS (PPU)	A, M, WF	NC
	RS (PPU)	A, M, WF	DAC
	P (PPU)	A, M, WF	NC
	CS (PPU)	A, M, WF	DAC
<b>RP-2001 (2)(h), RP-2001E (2)(h), RP-2002 (2)(h), RP-2002E (2)(h)</b>	L	A, M, SS, WF	March, NC
	AUX	A, M, WF	NC
	RS (PPU)	A, M, SS, WF	DAC, NC, Rev Pol
	P (PPU)	A, M, WF	C, DAC
	CS (PPU)	A, M, SS, WF	DAC
<b>S5000 #(b)</b>	AUX, L, P (PPU), RS (PPU)	A, M, SS, WF	C, NC
	CS (PPU)	A, M, WF	C, DAC, NC
	CS, RS (PPU)	A, M, SS, WF	DAC
	RS (PPU)	SS	Rev Pol
<b>S5000E (b)</b>	CS (PPU)	A, M, WF	C, DAC, NC
	CS, RS (PPU)	A, M, SS, WF	DAC
	RS (PPU)	SS	Rev Pol
<b>SFP-2402 (a)</b>	L	A, M, SS, WF	March, NC
	P (PPU)	A, M, SS, WF	C
	CS (PPU)	A, M, SS, WF	DAC

SFP-2402E (i), SFP-2404E (i)	L	A, M, SS, WF	March, NC
	AUX	A, M, WF	NC
	P (PPU)	A, M, SS, WF	C
	CS (PPU)	A, M, SS, WF	DAC
SFP-2404 (i)	L	A, M, SS, WF	March, NC
	AUX	A, M, WF	NC
	RS (PPU)	A, M, SS, WF	Rev Pol
	P (PPU)	A, M, SS, WF	C
	CS (PPU)	A, M, SS, WF	DAC
SFP-400* (j), SFP-400B* (j)	L	A, M, SS, WF	NC
	AUX	A, M, WF	NC
	RS (PPU)	A, M, SS, WF	Rev Pol
	RS (PPU)	A, M, WF	DAC
	P (PPU)	A, M, WF	NC
	CS (PPU)	A, M, WF	DAC
SFP-5UD (1)(h), SFP-10UD (1)(h), SFP-5UDE (1)(h), SFP-10UDE (1)(h), SFP-10UDC (1)(h), SFP-5UDC (1)(h)			
	L	A, M, SS, WF	March, NC
	AUX	A, M, WF	NC
	RS (PPU)	A, M, SS, WF	DAC, NC, OT, Rev Pol
	CS (PPU)	A, M, SS, WF	DAC, OT
	P (PPU)	A, M, SS, WF	C, DAC, OT
SGL-404	CS (PPU)	A, M, WF	NC
	AUX, L	A, M, SS, WF	NC
	RS (PPU)	A, M, WF	NC
XP Transponder #	L	A, M, WF	NC
	AUX, P (PPU)	A, M, WF	MX, NC

**Control Unit Subassemblies - Intended for use with compatible control units as described in the control unit installation manual, Model(s) 4XLM LED interface module, 4XTM transmitter module, 4XZM zone relay module**

**Enclosures, Model(s) BB-100(++++)(k), BB-100R, BB-200(++++)(k), BB-200R**

**Subassembly - Audio output board, Model(s) DVC-AO**

**Subassembly - Audio transformer, Model(s) DS-XF70V**

**Subassembly - Backup digital audio amplifier, Model(s) BDA-25V, BDA-70V, DS-BDA**

**Subassembly - Central processing unit board, Model(s) CPU2-640, CPU2-640E**

**Subassembly - CPU Board with display, Model(s) CPU2-3030D**

**Subassembly - CPU Board without display, Model(s) CPU2-3030ND**

**Subassembly - Digital Amplifier**, Model(s) DS-AMP/E

**Subassembly - Digital audio amplifiers**, Model(s) DAA-5025, DAA-5025E, DAA-5070, DAA-5070/E, DAA-5025EF, DAA-5025ESF, DAA-5025F, DAA-5025SF, DAA-5070F, DAA-5070SF, DAA-5070EF, DAA-5070ESF, DAA-7525F, DAA-7525SF, DAA2-5025, DAA2-5025E, DAA2-5070, DAA2-5070E, DAA2-7525, DAA2-7525E, DAX-3525, DAX-3525E, DAX-3570, DAX-3570E, DAX-5025, DAX-5025E, DAX-5070, DAX-5070E, DS-AMP, DS-AMPE

**Subassembly - Digital voice command**, Model(s) DVC, DVC-EM, DVC-EMF, DVC-EMSF

**Subassembly - Distribution board**, Model(s) DS-DB

**Subassembly - Fiber conversion module**, Model(s) DS-FM, DS-RFM, and DS-SFM

**Subassembly - Keypad board**, Model(s) DVC-KD

**Subassembly - Loop Control Module**, Model(s) LCM-320

**Subassembly - Loop Expander Module**, Model(s) LEM-320

**Subassembly - Microphone**, Model(s) CMIC-RP

**Subassembly - Network control module**, Model(s) NCM-F, NCM-W

**Subassembly - Power Supply**, Model(s) AMPS-24/E

**Subassembly - Power supply**, Model(s) DAA-PS, KAPS-24, KAPS-24E

**Subassembly - Remote paging unit**, Model(s) DVC-RPU

**Subassembly - Transmitter module**, Model(s) TM-4

**Supplementary Network Bridge**, Model(s) GW-WEBPORTAL, N-WEBPORTAL, SK-WEBPORTAL

L - Local System Type

A - Automatic fire alarm: Thermostats, smoke detectors, etc.

M - Manual fire alarm: Manually-operated boxes

SS - Sprinkler Supervisory: Gate valves, water-level switches, temperature switches, carbon monoxide detectors, residential fire alarm control units, etc.

WF - Waterflow alarm: Waterflow switches

C - Coded

NC - Noncoded

AUX - Auxiliary System Type

RS (PPU) - Remote Station System Type (Protected Premises Unit)

DAC - Digital Alarm Communicator

OT - Other Transmission Technologies

Rev Pol - Reverse Polarity

CS (PPU) - Central Station System Type (Protected Premises Unit)

P (PPU) - Proprietary System Type (Protected Premises Unit)

MX - Multiplex

March - March Time

CS - Central Station System Type

P (RU) - Proprietary System Type (Receiving Unit)

# - When Local (L) Type, System control unit with additional emergency voice communication, emergency telephone communication and paging.

(1) - Models are complementary Listed to FSZI, SYZV and QVAX.

(2) - Models are complementary Listed to FSZI, SYZV and QVAX when the System Type is Local.

(a) - When the Type Signaling is Coded (C) or Digital Alarm Communicator (DAC), see footnote +.

(b) - When Central Station (PPU) Type or Type Signaling is Digital Alarm Communicator (DAC), see footnote +.

(c) - When type signaling is OTHER TECHNOLOGIES, see footnote +

(d) - When Type Signaling is Digital Alarm Communicator (DAC), Coded (C) or Other Technologies (OT) see footnote +. When Type Signaling is Reverse Polarity - requires separately Listed Model 4XTMF transmitter module.

(e) - Noncoded (NC) or Coded (C) Type Signaling (except when Type is Local (L) Rev. Pol. Type Signaling, see footnote +.

(f) - When Type Signaling is Coded (C), Digital Alarm Communicator (DAC) or Reverse Polarity, see footnote +.

(g) - When Type Signaling is Coded (C), see footnote +.

(h) - When Type is Auxiliary or Type Signaling is Reverse Polarity- requires separately Listed Model 4XTMF transmitter Module. When the Type is any Protected Premises Unit (PPU) and the Type Signaling is Coded (C), Non Coded (NC) or Digital Alarm Communicator (DAC), see footnote +.

(i) - When the Type is Auxiliary or the Type Signaling is Coded (C) or Digital Alarm Communicator (DAC), see footnote +.

(j) - When Type Signaling is Reverse Polarity, see footnote +.

(k) - Note (+++++) - May include /R suffix.

\* - Protected Premises Unit when installed and interconnected with additional Listed equipment as described in the units installation instructions.

+ - Must be employed with additional specific Listed device(s) as indicated in installation instructions and wiring diagrams to provide indicated type service. The installation instructions for the Other Transmission Technologies transmitter will specify the compatible Notifier control unit model.

[Last Updated](#) on 2014-07-23

[Questions?](#)

[Print this page](#)

[Terms of Use](#)

[Page Top](#)

When the UL Leaf Mark is on the product, or when the word "Environment" is included in the UL Mark, please search the [UL Environment database](#) for additional information regarding this product's certification.

The appearance of a company's name or product in this database does not in itself assure that products so identified have been manufactured under UL's Follow-Up Service. Only those products bearing the UL Mark should be considered to be Certified and covered under UL's Follow-Up Service. Always look for the Mark on the product.

UL permits the reproduction of the material contained in the Online Certification Directory subject to the following conditions:  
1. The Guide Information, Assemblies, Constructions, Designs, Systems, and/or Certifications (files) must be presented in their entirety and in a non-misleading manner, without any manipulation of the data (or drawings). 2. The statement "Reprinted from the Online Certifications Directory with permission from UL" must appear adjacent to the extracted material. In addition, the reprinted material must include a copyright notice in the following format: "© 2014 UL LLC".

# DAA2 Series

## Digital Audio Amplifiers



Voice Control Systems

### General

The DAA2 Series amplifiers are multi-featured amplifiers with digital audio functionality. Each DAA2 is capable of accessing and processing one of up to eight audio channels on the DVC audio loop, amplifying the signal, and distributing it via four Class B or two Class A outputs. A DAA2-50 or DAA2-75 series amplifier is capable of mounting an optional BDA Digital amplifier, which can be used to provide one-to-one amplifier backup, or to support two-channel operation, or increased output wattage to 100W (100W option applies to DAA2-50 series only, other rules apply).

The DAA2 has two wire digital audio ports to connect to wire DAL (digital audio loop) segments. Either or both ports may be converted to fiber using fiber option modules.

Up to 32 devices, such as DAA2 amplifiers, can be connected to the DAL on one DVC Digital Voice Command unit. DAA2 amplifiers may be mixed with DAX and DAA series amplifiers on the same DAL.

An optional Firefighter telephone riser on the DAA2 supports local and network FFT communications. A DAA2 also supports use of an RM-1 remote microphone.

DAA2 amplifiers can store backup alarm and trouble messages, and provide an adjustable background music input.

### Features

- Listed to UL Standard 864, 9th edition.
- 50 W total output power at 25 V<sub>RMS</sub> (all DAA2-5025 models) or 70 V<sub>RMS</sub> (all DAA2-5070 models).
- 75 W total output power at 25 V<sub>RMS</sub> (all DAA2-7525 models).
- Supports two Class A high-level audio outputs; or four Class B outputs.
- Optional BDA amplifiers support alternative configurations.
  - Backup amplifier - supports one-to-one backup (all DAA2 models).
  - Primary amplifier - supports two-channel operation (all DAA2 models).
  - Primary amplifier - increase power up to 100W, one- or two-channel operation. (DAA2-50 series only, configuration rules apply.)
- Supports one-to-many amplifier backup applications using the same model DAA2.
- Firefighter telephone riser supports 7 active firefighter telephones. System Release 3.0 and higher supports optional configurations: direct connection for up to 7 firefighter telephones, or connection to multiple FTM-1 modules.
- Remote microphone paging option with RM-1.
- Audio output activation via network control-by-event equations resident within the DVC.
- Two wire digital audio ports that can be converted to fiber using fiber option modules. Support Style 4 or 7 configurations.



- Auxiliary input for 1 V<sub>RMS</sub>, to be used for background music input, an interface with a telephone paging source, or other compatible audio sources. Audio levels can be adjusted by end user. Optional supervision through programming.
- Isolated alarm bus input, to be used for backup activation of alarm messages when normal digital communication is lost.
- Programmable through **VeriFire® Tools**.
- Up to 106 seconds of backup digital message storage for use in the event of communication loss (from the **VeriFire® Tools** message library, or created by the installer).
- Battery charger disable provides battery sharing option for up to four DAA2s.
- Disconnect of deeply-discharged battery (low battery disconnect).

### Installation

The DAA2 arrives from the factory already installed on its chassis. The DAA2 mounts in one row of any EQ or CAB-4 Series cabinet: The CAB-4 row can be covered using a DP-1B dress panel, ordered separately.

One or two fiber option modules will plug directly onto a DAA2 for simple installation. A BDA backup amplifier mounts directly onto a DAA2.

Batteries for the DAA2 may be installed in any of the following configurations:

- In a CHS-BH1 optional battery chassis. The CHS-BH1 battery chassis will hold two 12.0 AH batteries, and mounts on the left side of the DAA2 chassis, so that the DAA2 and batteries are contained in a single cabinet tier.
- In the battery row (bottom) of the CAB-4 Series cabinet, or in the bottom row of an EQ Series cabinet.
- In a cabinet adjacent to the cabinet that holds the DAA2, with connections in conduit. External battery charging is supported.

## Specifications

### CPS-24 POWER SUPPLY BOARD

#### AC power (TB1)

- **Models using 120 VAC, 60 Hz input:**
  - DAA2-5025 - 4.68A max.
  - DAA2-5070 - 4.69A max.
  - DAA2-7525 - 4.68A max.
- **“E” version models using 220-240 VAC 60 Hz input:**
  - DAA2-5025E - 2.68A max.
  - DAA2-5070E - 2.68A max.
  - DAA2-7525E - 2.68A max.

**Recommended wiring:** 12 to 14 AWG (1.6 mm O.D.) with 600 VAC insulation.

**Shipping Weight:** 13 lb (5.9 kg).

**Secondary Power 5V and 24V AUX Outputs (TB2):**  
 24 V AUX: Power-limited, 24V @ 0.5A, utilizes wire sizes 12-18 AWG (3.31 mm<sup>2</sup> - 2.08 mm<sup>2</sup>).  
 5 V: Future Use.

**Battery Connections:** Supplied cable connections to batteries.

**Battery Charger:** Current-limited sealed lead acid battery charger which charges two 12 volt batteries in series, up to 200 AH.

	Charge 7 AH to 26 AH Batteries	Charge 26 AH to < 50 AH Batteries	Charge 50 AH to 200 AH Batteries
DAA2-5025 DAA2-5070	Yes	Yes	Yes
DAA2-7525	Yes	Yes	No
DAA2-5025 or DAA-5070 w/BDA in Group 2 of <i>VeriFire® Tools</i>	No	No	No

**Table 1: Battery Charging Capabilities**

#### DAA2 BOARDS

**Digital Audio Ports, wire media, A and B (TB2, TB3):** Maximum distance per segment is 1900 feet (579.12 m) on Belden 5320UJ (18AWG, TP) FPL cable: 18 AWG (0.821 mm<sup>2</sup>) twisted-pair, unshielded, power-limited. For approved cable types, see wiring documentation, P/N 52916ADD: *C Approved Wire Cables for Digital Audio Loops.*

**Digital Audio Ports, fiber media, fiber option modules:** Digital audio loop connectors support single- and multi-mode fiber with the use of fiber option modules. Refer to the Fiber Option Module datasheet for fiber specifications.

**Alarm Bus:** Power-limited, supervised by source. Recommended wiring: 14-18 AWG twisted-pair. Requires 16VDC minimum @ 20mA across the terminals to activate. Nominal 24VDC.

**Remote Microphone Interface:** RMI power: +24VDC, power-limited @ 100mA. Supervised. Recommended wiring: 14-18 AWG twisted-pair, Max. 14 AWG. Nominal AC signal strength 2.5V<sub>RMS</sub>, 3V<sub>RMS</sub> Max. Maximum distance between remote microphone and DAA2: 100 ft (304.8 m).

**FFT Riser:** Power-limited output, supervised. Class A or Class B operation. Class B 2-wire connections require a 3.9k

ohm 1/2 watt resistor (P/N R-3.9K). Max. wiring resistance (including individual telephone zone to last handset) permitted is 50 ohms, 10,000 ft (3048 m) max. wiring distance at 14 AWG to last handset.

**Auxiliary Input:** Signal strength from low-level analog audio input (such as background music or telephone paging): 1V<sub>p-p</sub> max. Optional supervision through programming. Recommended wiring: 14-18 AWG, twisted-pair. Auxiliary input source must be within 25 ft. (7.6 m) of the DAA2, and within the same room.

**Speaker circuits:** Power-limited outputs (exception: a DAA2-5070 speaker circuit used with any Canadian Room Isolator module is non-power limited. Speaker circuit 1 (TB10) can not be used.). Supervision determined by programming. DAA2-5025/70, Each circuit rated up to 50 watts\*. DAA2-7525, each circuit rated up to 75 watts\*. Recommended wiring: 12-18 AWG twisted-pair (shielded recommended). Class B or Class A: Class B requires 20k end-of-line resistors (included, P/N ELR-20K). Class A requires 10k end-of-line resistors (included, P/N R-10K) on the return.

\*total wattage may vary per configuration.

**Backup:** High-level audio input: 25V<sub>RMS</sub> (DAA2-5025 and DAA2-7525). 70 V<sub>RMS</sub> (DAA2-5070). Recommended wiring: 14-18 AWG. Not supervised when inactive. Supervised by backup source when active. Must be in same room or enclosure.

## Standards and Codes

The DAA2 Series Digital Audio Amplifiers comply with the following standards:

- NFPA 72 2007 National Fire Alarm Code
- Underwriter Laboratories Standard UL 864
- Underwriter Laboratories of Canada (ULC) ULC-S527-99 Standard of Control Units for Fire Alarm Systems.
- Part 15 Class A conducted and radiated emissions as required by the FCC.
- IBC 2012, IBC 2009, IBC 2006, IBC 2003, IBC 2000 (Seismic).
- CBC 2007 (Seismic)

## Listings and Approvals

These listings and approvals apply to the basic DAA2 Series Digital Audio Amplifiers. In some cases, certain modules may not be listed by certain agencies, or listing may be in process. Consult factory for latest listing status.

- UL Listed: S635.
- ULC Listed: S635.
- CSFM: 7165-0028:0234 (NFS2-640/NFS-320), 7165-0028:0224 (NFS2-3030).
- Fire Dept. of New York: COA#6121 (NFS2-640/NFS-320), COA#6114 (NFS2-3030).

## Product Line Information

### 50 WATT DAA2 AMPLIFIERS

Shipped mounted to the chassis.

**DAA2-5025:** 120 VAC Digital Audio Amplifier (50 W, 25 V<sub>RMS</sub>).

**DAA2-5070:** 120 VAC Digital Audio Amplifier (50 W, 70 V<sub>RMS</sub>).

**DAA2-5025E:** 220-240 VAC Digital Audio Amplifier (50 W, 25 V<sub>RMS</sub>).

**DAA2-5070E:** 220-240 VAC Digital Audio Amplifier (50 W, 70 V<sub>RMS</sub>).

#### **75 WATT DAA2 AMPLIFIERS**

Shipped mounted to the chassis.

**DAA2-7525:** 120 VAC Digital Audio Amplifier (75 W, 25 V<sub>RMS</sub>).

**DAA2-7525E:** 220-240 VAC Digital Audio Amplifier (75 W, 25 V<sub>RMS</sub>).

#### **BDA BACKUP DIGITAL AMPLIFIERS**

**BDA-25V:** Backup Digital Amplifier (25 V<sub>RMS</sub>), switch settings for 75, 50, and 35 W operation. Provides a second audio channel when programmed as a primary amplifier.

**BDA-70V:** Backup Digital Amplifier (70 V<sub>RMS</sub>), switch settings for 50 and 35 W operation. Provides a second audio channel when programmed as a primary amplifier.

#### **FIBER OPTION MODULES**

**DS-FM:** Fiber option module for multi-mode fiber. Converts a wire DAP (digital audio port) to a multi-mode fiber port.

**DS-SFM:** Fiber option module for single-mode fiber. Converts a wire DAP (digital audio port) to a single-mode fiber port.

**DS-RFM:** Fiber option module for multi-mode fiber. Used exclusively for compatibility with multi-mode fiber DVC or DAA.

#### **ACCESSORIES**

**CHS-BH1:** Battery chassis. Holds two 12.0 AH batteries. Mounts on the left side of the DAA2 chassis.

**DP-1B:** Dress panel: covers one tier of CAB-4 Series cabinet.

**ACT-25, ACT-70:** Audio-coupling transformers. Used with AA-30 or DAA2-series amplifiers to drive thousands of amplifiers in large system applications.

**SEISKIT-DAA:** Seismic kit for DAA, DAA2, and DAX series amplifiers. Required when using CHS-BH1 chassis. Includes battery bracket for two 12AH Power Sonic batteries. See document 53851.

**NOTIFIER®** and **VeriFire® Tools** are registered trademarks of Honeywell International Inc.  
©2014 by Honeywell International Inc. All rights reserved. Unauthorized use of this document is strictly prohibited.



This document is not intended to be used for installation purposes.  
We try to keep our product information up-to-date and accurate.  
We cannot cover all specific applications or anticipate all requirements.  
All specifications are subject to change without notice.



For more information, contact Notifier. Phone: (203) 484-7161, FAX: (203) 484-7118.  
[www.notifier.com](http://www.notifier.com)



## PGWM.S635 Control and Communication Equipment

[Page Bottom](#)

### Control and Communication Equipment

[See General Information for Control and Communication Equipment](#)

#### NOTIFIER

S635

12 Clintonville Rd  
Northford, CT 06472-1610 USA

**Addressable Power Supply**, Model(s) ACPS-610

**Amplifier**, Model(s) NFC-BDA-25 (a, b), NFC-BDA-70V (a, b)

**Amplifier - Subassembly**, Model(s) NFC-BDA-BU (g)

**Amplifiers**, Model(s) NFC-125DA\$, NFC-125DAE\$, NFC-50DA\$, NFC-50DAE\$

**Annunciator control module**, Model(s) ACM-16AT,-16ATG,-16ATY,-24AT,-32A,-32AG,-32AY,48A

AEM-16AT,-16ATG,-16ATY,-24AT,-32A,-32G,-32Y,-48A

**Autonomous Control Unit**, Model(s) NCA-2 with AMPS-24, DVC-KD, ACM-24AT or AEM-24AT, and 2 NCM-W

NCA-2/DVC with displayless NFS2-640, 3 NCM-W, CMIC, and CFFT,

NCA-2/DVC with NCM-W

NFS2-3030, NFS2-3030E, XLS3000, all with AMPS-24/E, DVC-KD, ACM-24AT or AEM-24AT, and 2 NCM-W

**Autonomous control units**, Model(s) NFC-50/100DA (g), NFC-50/100DAE (c)

**Circuit Expander**, Model(s) NFC-CE6 (a, b)

**Compatible Control Panel**, Model(s) NFS2-640/E (R), NFS-320/E (R), NFS-320C (R), NFS-320SYS, NFS-320SYS-FR, and NFS-320SYS/E

**Control Modules**, Model(s) FCM-1

**dual monitor module**, Model(s) FDM-1

**Dual Monitor Modules**, Model(s) NDM-100

**Emergency Command Center - ACU**, Model(s) NFC-50/100 (a,b), NFC-50/100E (a,b)

**Input Monitor Modules**, Model(s) XP10-M

**Input/Output Relay Module**, Model(s) FDRM-1

**Local Operator Console**, Model(s) DVC-RPU with LCD-160, NCA-2 with NCM-F, DVC, and AMPS-24, NCA-2/DVC with NCM-F and LCD-160, NFC-LOC (a, b)

**Monitor Modules**, Model(s) FMM-1, FMM-101

**Relay Modules**, Model(s) FRM-1, XP6-R

**Remote Annunciator**, Model(s) LCD-160, NCA-2

**Repeater**, Model(s) RPT-WF, RPT-W

**Speaker Expander module**, Model(s) NFC-CE4\$

**Subassembly - Audio output board**, Model(s) DVC-AO

**Subassembly - Audio transformer**, Model(s) DS-XF70V

**Subassembly - Backup digital audio amplifier**, Model(s) BDA-25V, BDA-70V, DS-BDA

**Subassembly - Central processing unit board**, Model(s) CPU2-640, CPU2-640E

**Subassembly - Central Processing Unit with Display**, Model(s) CPU2-3030D

**Subassembly - CPU board without display**, Model(s) CPU2-3030ND

**Subassembly - Digital Amplifier**, Model(s) DS-AMP/E

**Subassembly - Digital audio amplifier**, Model(s) DAA2-5025, DAA2-5025E, DAA2-5070, DAA2-5070E, DAA2-7525, DAA2-7525E, DAX-3525, DAX-3525E, DAX-3570, DAX-3570E, DAX-5025, DAX-5025E, DAX-5070, DAX-5070E

DS-BDA

**Subassembly - Digital voice command**, Model(s) DVC, DVC-EM, DVC-EMF, DVC-EMSF

**Subassembly - Distribution Board**, Model(s) DS-DB

**Subassembly - Fiber conversion module**, Model(s) DS-FM, DS-RFM, and DS-SFM

**Subassembly - Keypad board**, Model(s) DVC-KD

**Subassembly - Loop Control Module**, Model(s) LCM-320

**Subassembly - Loop Expander Module**, Model(s) LEM-320

**Subassembly - Microphone**, Model(s) CMIC-RP

**Subassembly - Network control module**, Model(s) NCM-F, NCM-W

**Subassembly - Power supply**, Model(s) AMPS-24/E, KAPS-24, KAPS-24E

**Subassembly - Remote paging unit**, Model(s) DVC-RPU

**Subassembly - Transmitter module**, Model(s) TM-4

**Supervising Control Modules**, Model(s) XP6-C

**Supplementary Ethernet Gateway**, Model(s) BacNet, ModBus

**Supplementary Gateway**, Model(s) NWS-3

**Supplementary Network Bridge**, Model(s) N-WEBPORTAL

**Transformer modules**, Model(s) NFC-XRM-70V (a,b)

\$ - Investigated to UL Subject 2572, "Outline of Investigation for Control and Communication Units for Mass Notification Systems"

& - Investigated to ANSI/UL 2572, "Mass Notification Systems"

(c) - Investigated to ANSI/UL 2572, "Mass Notification Systems"

(g) - Investigated to ANSI/UL 2572, " Mass Notification Systems"

Last Updated on 2014-07-17

---

[Questions?](#)

[Print this page](#)

[Terms of Use](#)

[Page Top](#)

© 2015 UL LLC

The appearance of a company's name or product in this database does not in itself assure that products so identified have been manufactured under UL's Follow-Up Service. Only those products bearing the UL Mark should be considered to be Certified and covered under UL's Follow-Up Service. Always look for the Mark on the product.

UL permits the reproduction of the material contained in the Online Certification Directory subject to the following conditions: 1. The Guide Information, Assemblies, Constructions, Designs, Systems, and/or Certifications (files) must be presented in their entirety and in a non-misleading manner, without any manipulation of the data (or drawings). 2. The statement "Reprinted from the Online Certifications Directory with permission from UL" must appear adjacent to the extracted material. In addition, the reprinted material must include a copyright notice in the following format: "© 2015 UL LLC".

# CAB-4 Series Cabinets

## ONYX® Series Backboxes with Locking Doors



Peripheral Devices

### General

All cabinets for NOTIFIER fire alarm control panels are fabricated from 16-gauge steel. The cabinet assembly consists of two basic parts: a backbox and a locking door. Cabinets are available in either black or red, with or without windows. The window model provides a tasteful combination to accent the decor of the finest lobby setting.

- The **key-locked door** is provided with a pin-type hinge, two keys and the necessary hardware to mount the door to the backbox.
- The **backbox** has been engineered to provide ease-of-entry for the installer. **Knockouts** are positioned at numerous points to aid the installer in bringing a conduit into the enclosure with a minimum of hardship.
- **Right- or left-hand hinges**, selectable in the field. Door opens 180°.
- Cabinets are arranged in **four standard sizes**, A (one tier) through D (four tiers), plus a **mini cabinet** (AA, one tier without a battery compartment). See *Ordering Information*.
- A **trim ring option** is available for semi-flush mounting.
- **Chassis bridge** available for assembling multiple CHS-4 chassis external to the backbox.

### Ordering Information

A complete cabinet assembly consists of: a door, a backbox, an optional battery plate, and an optional semi-flush trim ring. For each cabinet required, order one "DR" door and one "SBB" backbox. The BP-4 or BP2-4 battery plate is required for each cabinet assembly that mounts batteries and/or a power supply in the lower position of the cabinet. The optional trim ring is an attractive "picture frame"-style black metal ring.

#### MINI "AA" SIZE, ONE TIER:

**DR-AA4:** Door assembly, window, one tier (no battery compartment), BLACK.

**DR-AA4R:** Door assembly, window, one tier (no battery compartment), RED.

**DR-AA4B:** Door assembly, solid door, one tier (no battery compartment), BLACK.

**DR-AA4BR:** Door assembly, solid door, one tier (no battery compartment), RED.

**SBB-AA4:** Backbox assembly, one tier (no battery compartment), BLACK.

**SBB-AA4R:** Backbox assembly, one tier (no battery compartment), RED.

**TR-AA4:** Accessory semi-flush-mount trim ring, one tier (no battery compartment).

**NOTE:** Black trim rings are used with red or black cabinets.

#### ONE TIER, "A" SIZE:

**DR-A4:** Door assembly, window, one tier, BLACK.

**DR-A4R:** Door assembly, window, one tier, RED.

**DR-A4B:** Door assembly, solid door, one tier, BLACK.

**DR-A4BR:** Door assembly, solid door, one tier, RED.

**SBB-A4:** Backbox assembly, one tier, BLACK.

**SBB-A4R:** Backbox assembly, one tier, RED.



NFS2-3030 and DVC in "C" sized CAB-4 cabinet

**TR-A4:** Accessory semi-flush-mount trim ring, one tier (opening 24.062" [61.118 cm] W x 20.062" [50.958 cm] H), BLACK.

**NOTE:** Black trim rings are used with red or black cabinets.

**BP-4:** Battery panel for NFS-640 and NFS-3030. Used to cover battery and power supply when lower position is used in backbox.

**BP2-4:** Battery panel for NFS2-3030. Used to cover battery and power supply when lower position is used in backbox.

#### TWO TIERS, "B" SIZE:

**DR-B4:** Door assembly, window, two tiers, BLACK.

**DR-B4R:** Door assembly, window, two tiers, RED.

**DR-B4B:** Door assembly, solid door, two tiers, BLACK.

**DR-B4BR:** Door assembly, solid door, two tiers, RED.

**SBB-B4:** Backbox assembly, two tiers, BLACK.

**SBB-B4R:** Backbox assembly, two tiers, RED.

**TR-B4:** Accessory semi-flush-mount trim ring, two tiers (opening 24.062" [61.118 cm] W x 28.562" [72.548 cm] H), BLACK.

**NOTE:** Black trim rings are used with red or black cabinets.

**BP-4:** Battery panel for NFS-640 and NFS-3030. Used to cover battery and power supply when lower position is used in backbox.

**BP2-4:** Battery panel for NFS2-3030. Used to cover battery and power supply when lower position is used in backbox.

#### THREE TIERS, "C" SIZE:

**DR-C4:** Door assembly, window, three tiers, BLACK.

**DR-C4R:** Door assembly, window, three tiers, RED.

**DR-C4B:** Door assembly, solid door, three tiers, BLACK.

**DR-C4BR:** Door assembly, solid door, three tiers, RED.

**SBB-C4:** Backbox assembly, three tiers, BLACK.

**SBB-C4R:** Backbox assembly, three tiers, RED.

**TR-C4:** Accessory semi-flush-mount trim ring, three tiers (opening 24.062" [61.118 cm] W x 37.187" [94.455 cm] H), BLACK.

**NOTE:** Black trim rings are used with red or black cabinets.

**BP-4:** Battery panel for NFS-640 and NFS-3030. Used to cover battery and power supply when lower position is used in backbox.

**BP2-4:** Battery panel for NFS2-3030. Used to cover battery and power supply when lower position is used in backbox.

**FOUR TIERS, "D" SIZE:**

**DR-D4:** Door assembly, window, four tiers, BLACK.

**DR-D4R:** Door assembly, window, four tiers, RED.

**DR-D4B:** Door assembly, solid door, four tiers, BLACK.

**DR-D4BR:** Door assembly, solid door, four tiers, RED.

**SBB-D4:** Backbox assembly, four tiers, BLACK.

**SBB-D4R:** Backbox assembly, four tiers, RED.

**TR-D4:** Accessory semi-flush-mount trim ring, four tiers (opening 24.062" [61.118 cm] W x 45.812" [116.363 cm] H), BLACK.

**Note:** Black trim rings are used with red or black cabinets.

**BP-4:** Battery panel for NFS-640 and NFS-3030. Used to cover battery and power supply when lower position is used in backbox.

**BP2-4:** Battery panel for NFS2-3030. Used to cover battery and power supply when lower position is used in backbox.

**ACCESSORIES:**

**WC-2:** Wire channel. Provides a pair of wire trays to neatly route wiring between CHS chassis.

**CB-1:** Chassis bridge. Provides a bridge between CHS Series chassis.

**DP-1B:** Blank dress panel, covers one CAB-4 tier, BLACK.

**ADP-4B:** Annunciator dress panel.

**VP-2B:** Ventilator panel.

**Agency Listings and Approvals**

These listings and approvals below apply to the CAB-4 Series Cabinets. In some cases, certain modules or applications may not be listed by certain approval agencies, or listing may be in process. Consult factory for latest listing status.

- **UL** Listed: file S635 (except AA size).
- **ULC** Listed: file CS118 (except AA size).
- **MEA** approved: files 317-01-E, 345-02-E (except AA size).
- **CSFM** approved (except AA size): files 7165-0028:0243 (NFS2-640), 7165-0028:0224 (NFS2-3030).
- **FM** approved (except AA size).
- **U.S. Coast Guard** approved: 161.002/42/1 (NFS-640).
- **FDNY** COA# 6038, COA# 6058.

**Cabinet Dimensions and Features**

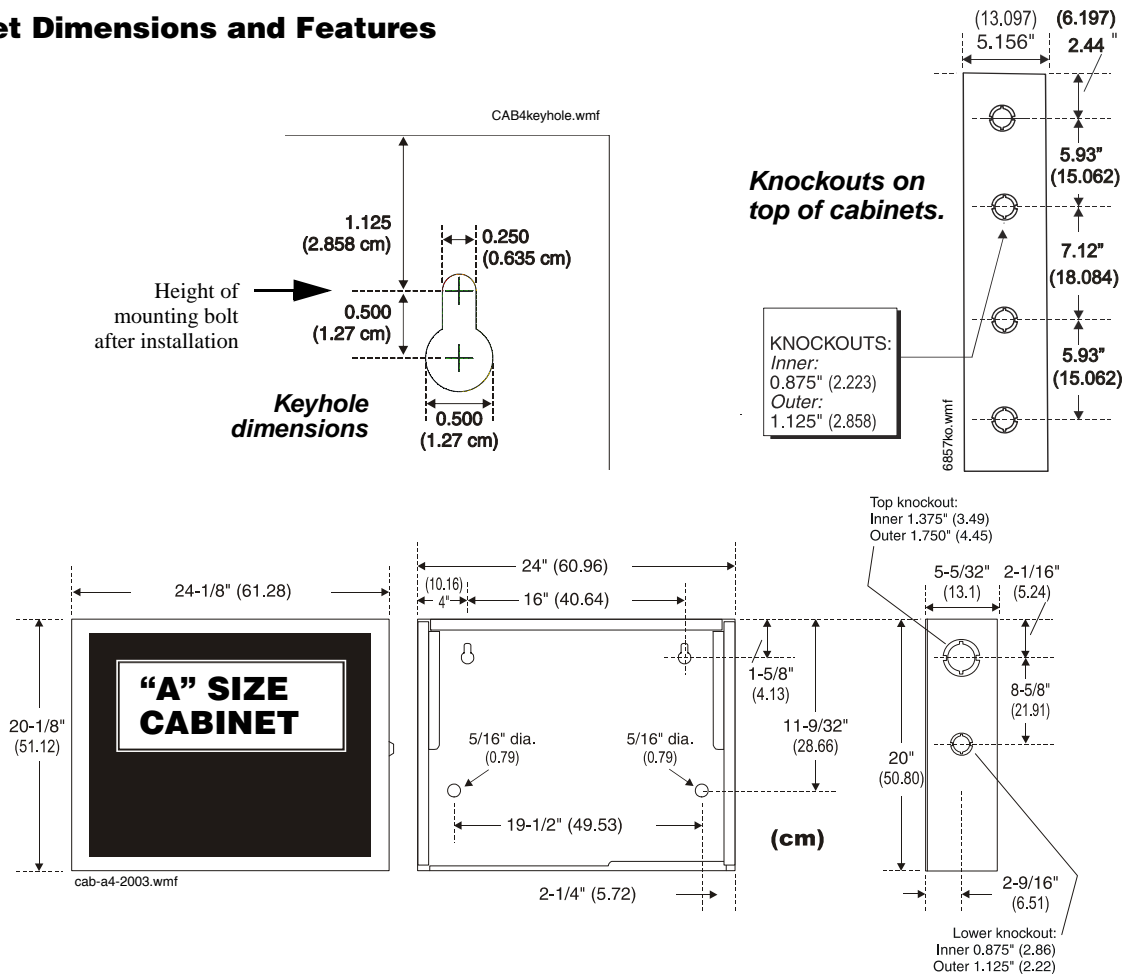

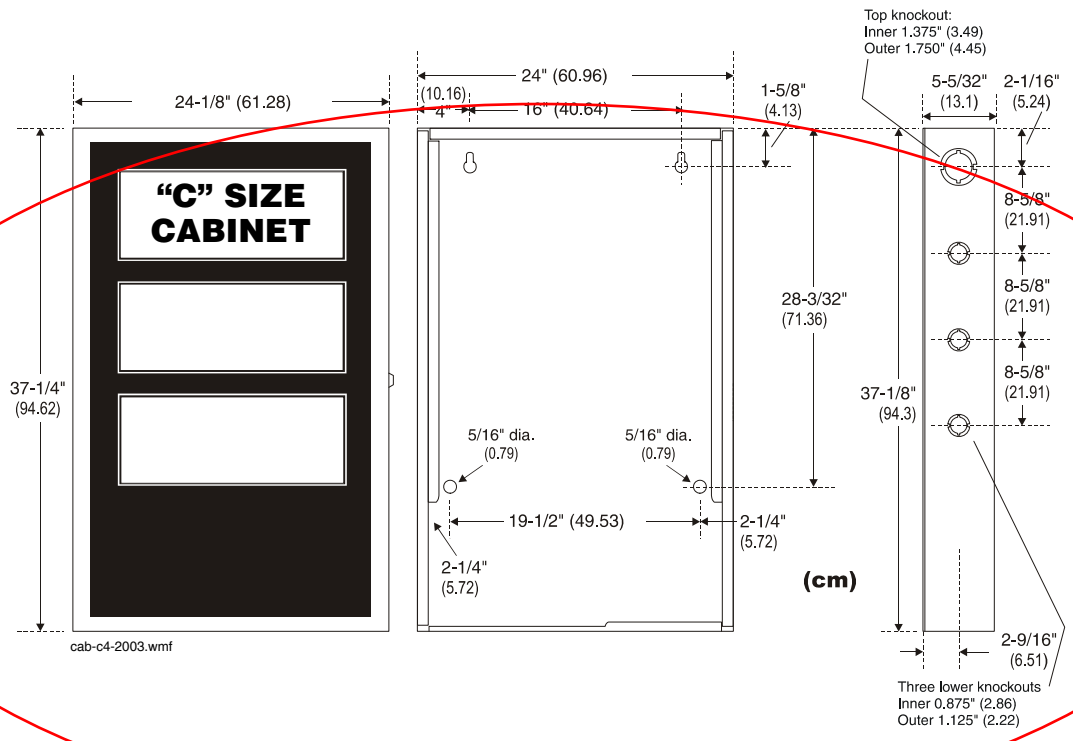
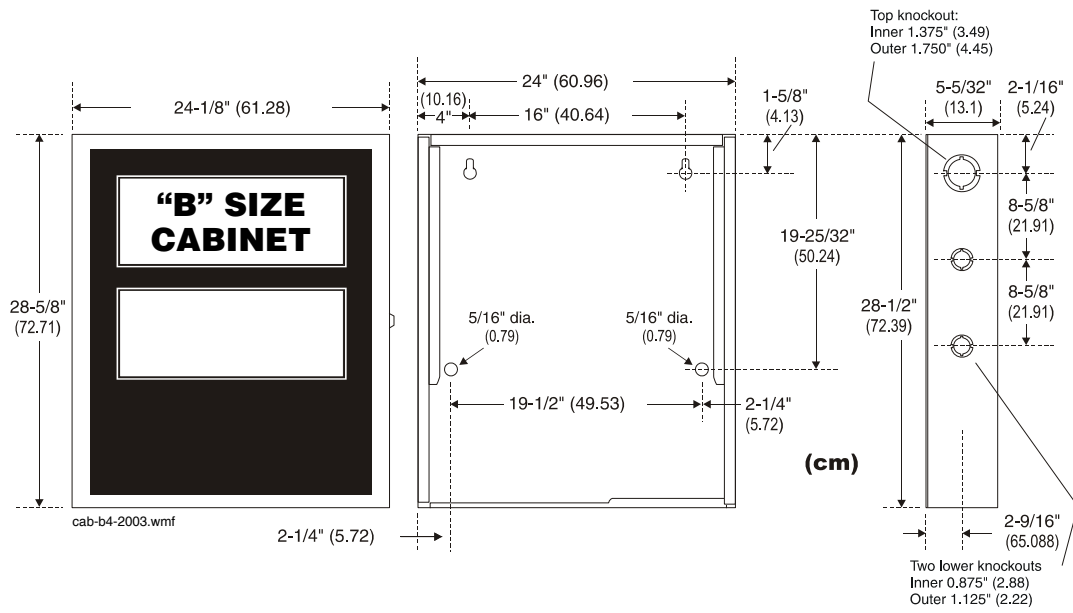
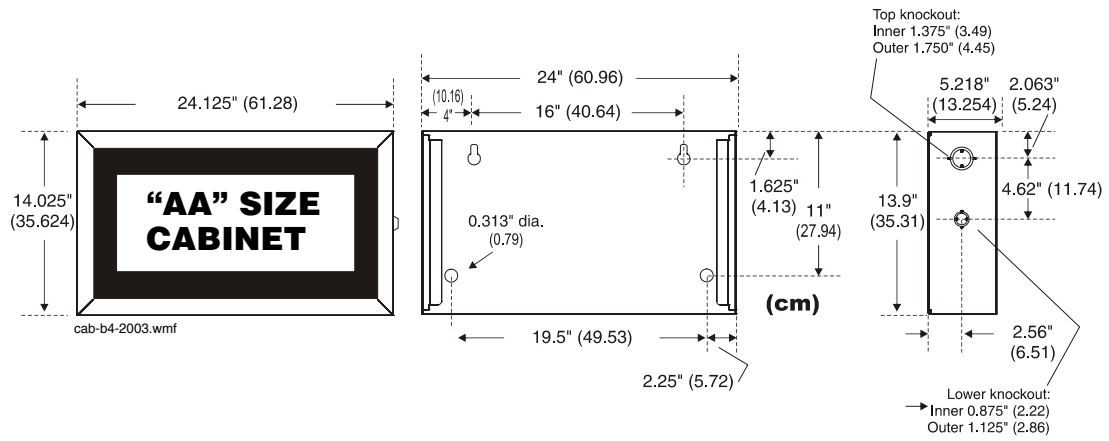

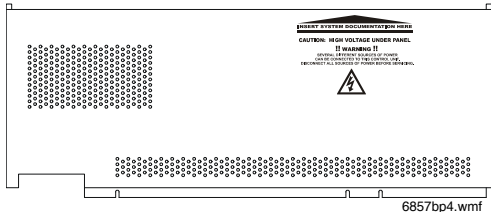
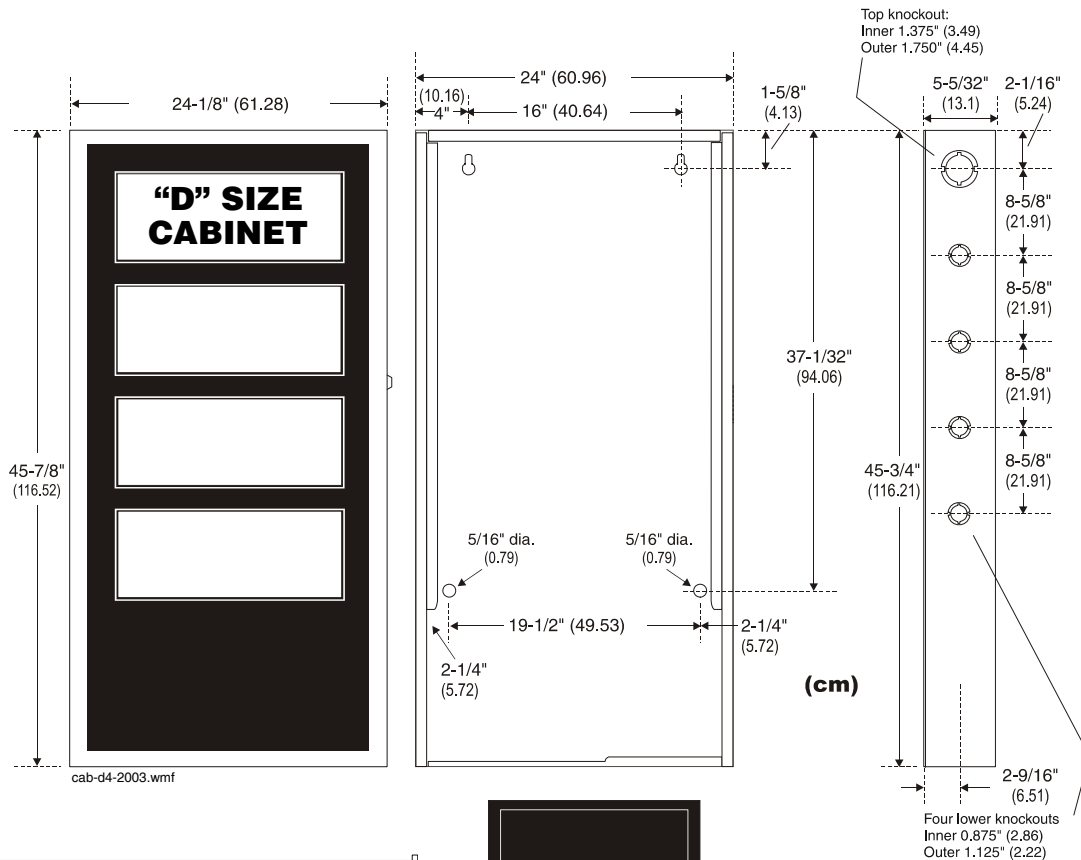

**The BP-4 Battery Dress Panel covers the Main Power Supply and the batteries in the cabinet. Only one BP-4 or BP2-4 is required per cabinet unless an AA cabinet is used (no battery compartment).**

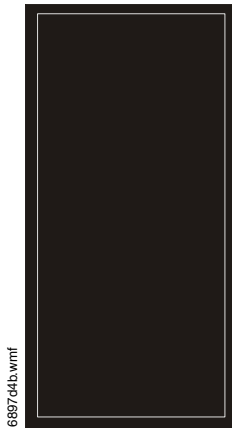

**"D" sized cabinet with solid door. Solid door option available on all sizes in black or red.**

ONYX® and NOTIFIER® are registered trademarks of Honeywell International Inc.  
 ©2010 by Honeywell International Inc. All rights reserved. Unauthorized use of this document is strictly prohibited.



This document is not intended to be used for installation purposes. We try to keep our product information up-to-date and accurate. We cannot cover all specific applications or anticipate all requirements. All specifications are subject to change without notice.



For more information, contact Notifier. Phone: (203) 484-7161, FAX: (203) 484-7118.  
[www.notifier.com](http://www.notifier.com)

**QVAX.S635**  
**Process Management Equipment**

[Page Bottom](#)

**Process Management Equipment**

[See General Information for Process Management Equipment](#)

**NOTIFIER**

S635

12 CLINTONVILLE RD  
NORTHFORD, CT 06472 USA

**Dress panel:**, Model BMP 1.

**Fire alarm equipment**, Models CAB-A4, CAB-B4, CAB-C4, CAB-D4, CAB-PS1, DR-PS1, BB-100, BB-200, ABF-1(+), ABF-2(+), ABF-4(+), ABS-1(+), ABS-1T(+), ABS-2(+), ABS-2D(+), ABS-4D(+), ABS-8R(+), CA-1, CA-2, EQBB-B4(R), EQBB-C4(R), EQBB-D4(R), SBB-AA4, SBB-AA4R, SBB-AA4B, BB-UZC Enclosures; Models DR-A4(+), DR-B4(+), DR-C4(+), DR-D4(+), ADDR-B4(+), ADDR-C4(+), ADDR-D4(+), EQDR-B4(R), EQDR-C4(R), EQDR-D4(R), DR-AA4, DR-AA4R, DR-AA4BR Doors. (The CAB-AA4 backox Series is made up of the SBB-AA4, SBB-AA4R, SBB-AA4B, SBB-AA4BR enclosures, and the DR-AA4, DR-AA4B, DR-AA4R, DR-AA4BR Doors). Models SBB-A4(+), SBB-B4(+), SBB-C4(+), SBB-D4(+), SBB-D4(+) Backboxes; Models BP-4, BP2-4, ADP-4B, DPDW-1B, DPSW-1B, VP-2B, BMP-1, DP-1B, MP-1B, BM-1B Dress panels; Models CHS-M2, CHS-M3, CHS-4N, CHS-BH1 Battery holder chassis.

**Fire alarm with critical and noncritical processing control units**, Models (1) SFP-5UD, SFP-10UD, SFP-5UDE, SFP-10UDE, SFP-10UDC, SFP-5UDC, NFS2-3030(E), XLS-3000, NFS2-640(E), NFS-320(E).

Models (2) N-ANN-LED, N-ANN-RLED, annunciator modules. Intended for use with compatible control units as described in the individual control unit installation manual.

Model (2) N-ANN-RLY, relay module. Intended for use with compatible control units as described in the individual control unit installation manual.

Models NFS2-640/E (R), NFS-320/E (R), NFS-320C (R), NFS-320SYS, NFS-320SYS/E Fire Alarm Control Units.

**Sub-assembly - class A conversion modules**, Model (1) N-CAC-5X (1). Intended for use with compatible control units as described in the individual control unit installation manual.

**Remote annunciators (3)**LCD-160, LCD-80, LCD2-80.

Model N-ANN-I/O†(f01).

**Routers**, Model BACNet Gateway, BacNet-2, BacNet-GW-3, ONYXBAC, MODBUS-GW.

**Serial/parallel interface**, Model N-ANN-S/PG †.

**Type AM and SM fire alarm system control units**, Models(4) FireWarden-50, FireWarden-50E. Suitable for noncritical process monitoring.

Models FireWarden-100-2, FireWarden-100-2E.

**WEB servers, NWS, NWS-2, NCA-2.**

(+) - May include /R, /F or /B suffix.

(1) These models are complementary Listed to UOJZ.

(2) These models are complementary Listed to SYSW and UOXX.

(3) These models are complementary Listed to UOXX.

(4) These models are complementary Listed to DAYRC, FXSZI, UOJZ and UOJZC.

† Complementary Listed under FSYE, UOXX, UOXXC.

(f01) - Intended for use with specific control units as indicated in control unit installation manual.

[Last Updated](#) on 2010-10-26

[Questions?](#)

[Print this page](#)

[Notice of Disclaimer](#)

[Page Top](#)

[Copyright © 2010 Underwriters Laboratories Inc.®](#)

The appearance of a company's name or product in this database does not in itself assure that products so identified have been manufactured under UL's Follow-Up Service. Only those products bearing the UL Mark should be considered to be Listed and covered under UL's Follow-Up Service. Always look for the Mark on the product.

UL permits the reproduction of the material contained in the Online Certification Directory subject to the following conditions:  
1. The Guide Information, Designs and/or Listings (files) must be presented in their entirety and in a non-misleading manner, without any manipulation of the data (or drawings). 2. The statement "Reprinted from the Online Certifications Directory with permission from Underwriters Laboratories Inc." must appear adjacent to the extracted material. In addition, the reprinted material must include a copyright notice in the following format: "Copyright © 2010 Underwriters Laboratories Inc.®"

**NBG-12LX****Addressable Manual Pull Station**

Intelligent/Addressable Devices

**General**

The Notifier NBG-12LX is a state-of-the-art, dual-action (i.e., requires two motions to activate the station) pull station that includes an addressable interface for any Notifier intelligent control panel except FireWarden series panels, and the NSP-25 panel. Because the NBG-12LX is addressable, the control panel can display the exact location of the activated manual station. This leads fire personnel quickly to the location of the alarm.

**Features**

- Maintenance personnel can open station for inspection and address setting without causing an alarm condition.
- Built-in bicolor LED, which is visible through the handle of the station, flashes in normal operation and latches steady red when in alarm.
- Handle latches in down position and the word “ACTIVATED” appears to clearly indicate the station has been operated.
- Captive screw terminals wire-ready for easy connection to SLC loop (accepts up to 12 AWG/3.25 mm<sup>2</sup> wire).
- Can be surface mounted (with SB-10 or SB-I/O) or semi-flush mounted. Semi-flush mount to a standard single-gang, double-gang, or 4" (10.16 cm) square electrical box.
- Smooth dual-action design.
- Meets ADAAG controls and operating mechanisms guidelines (Section 4.1.3[13]); meets ADA requirement for 5 lb. maximum activation force.
- Highly visible.
- Attractive shape and textured finish.
- Key reset.
- Includes Braille text on station handle.
- Optional trim ring (BG12TR).
- Meets UL 38, Standard for Manually Actuated Signaling Boxes.
- Up to 99 NBG-12LX stations per loop on CLIP protocol loops.
- Up to 159 NBG-12LX stations per loop on FlashScan® protocol loops.
- Dual-color LED blinks green to indicate normal on FlashScan® systems.

**Construction**

Shell, door, and handle are molded of durable polycarbonate material with a textured finish.

**Specifications**

- **Shipping Weight:** 9.6 oz. (272.15 g)
- **Normal operating voltage:** 24 VDC.
- **Maximum SLC loop voltage:** 28.0 VDC.
- **Maximum SLC loop current:** 375  $\mu$ A.
- **Temperature Range:** 32°F to 120°F (0°C to 49°C)
- **Relative Humidity:** 10% to 93% (noncondensing)
- **For use indoors in a dry location**



**The NBG-12LX  
Addressable Manual Pull Station**

**Installation**

The NBG-12LX will mount semi-flush into a single-gang, double-gang, or standard 4" (10.16 cm) square electrical outlet box, or will surface mount to the model SB-10 or SB-I/O surface backbox. If the NBG-12LX is being semi-flush mounted, then the optional trim ring (BG12TR) may be used. The BG12TR is usually needed for semi-flush mounting with 4" (10.16 cm) or double-gang boxes (not with single-gang boxes).

**Operation**

Pushing in, then pulling down on the handle causes it to latch in the down/activated position. Once latched, the word “ACTIVATED” (in bright yellow) appears at the top of the handle, while a portion of the handle protrudes from the bottom of the station. To reset the station, simply unlock the station with the key and pull the door open. This action resets the handle; closing the door automatically resets the switch.

Each manual station, on command from the control panel, sends data to the panel representing the state of the manual switch. Two rotary decimal switches allow address settings (1 – 159 on FlashScan® systems, 1 – 99 on CLIP systems).

**Architectural/Engineering Specifications**

Manual Fire Alarm Stations shall be non-coded, with a key-operated reset lock in order that they may be tested, and so designed that after actual Emergency Operation, they cannot be restored to normal except by use of a key. An operated station shall automatically condition itself so as to be visually detected as activated. Manual stations shall be constructed of red-colored polycarbonate material with clearly visible operating instructions provided on the cover. The word FIRE shall appear on the front of the stations in white letters, 1.00 inches (2.54 cm) or larger. Stations shall be suitable for surface mounting on matching backbox SB-10 or SB-I/O; or semi-flush mounting on a standard single-gang, double-gang, or 4"

(10.16 cm) square electrical box, and shall be installed within the limits defined by the Americans with Disabilities Act (ADA) or per national/local requirements. Manual Stations shall be Underwriters Laboratories listed.

Manual stations shall connect with two wires to one of the control panel SLC loops. The manual station shall, on command from the control panel, send data to the panel representing the state of the manual switch. Manual stations shall provide address setting by use of rotary decimal switches.

The loop poll LED shall be clearly visible through the front of the station. The LED shall flash while in the normal condition, and stay steadily illuminated when in alarm.

## Product Line Information

**NBG-12LX:** Dual-action addressable pull station. Includes key locking feature.

**SB-10:** Surface backbox; metal.

**SB-I/O:** Surface backbox; plastic.

**BG12TR:** Optional trim ring.

**17021:** Keys, set of two.

**NY-Plate:** New York City trim plate

## Agency Listings and Approvals

In some cases, certain modules or applications may not be listed by certain approval agencies, or listing may be in process. Consult factory for latest listing status.

- **UL / CUL Listed:** S692 (listed for Canadian and non-Canadian applications)
- **MEA:** 67-02-E
- **CSFM:** 7150-0028:0199
- **FDNY:** COA #6038 (NFS2-640), COA #6058 (NFS2-3030)
- **BSMI:** CI313066760047
- **U.S. Coast Guard:** 161.002/23/3 (AFP-200); 161.002/27/3 (AM-2020/AFP-1010; 161.002/42/1 (NFS-640)
- **Lloyd's Register:** 02/6007 (NFS-640); 94/60004 (E2) (AFP-200); 03/60011 (E1); 07/60007 (NFS2-3030)
- **FM Approved**

**Patented:** U.S. Patent No. D428,351; 6,380,846; 6,314,772; 6,632,108.



---

Notifier® and FlashScan® are a registered trademarks of Honeywell International Inc.  
©2010 by Honeywell International Inc. All rights reserved. Unauthorized use of this document is strictly prohibited.

---



This document is not intended to be used for installation purposes.  
We try to keep our product information up-to-date and accurate.  
We cannot cover all specific applications or anticipate all requirements.  
All specifications are subject to change without notice.



Made in the U.S. A.

For more information, contact Notifier. Phone: (203) 484-7161, FAX: (203) 484-7118.  
[www.notifier.com](http://www.notifier.com)

**UNIU.S692**  
**Boxes, Non-coded**

[Page Bottom](#)

**Boxes, Non-coded**

[See General Information for Boxes, Non-coded](#)

**NOTIFIER**

S692

12 CLINTONVILLE RD  
NORTHFORD, CT 06472 USA

Models BG-1, -1-2W, BNG-1(X), -1F, -1FTS, -1TS, -1SP, BRG-1, -1FTS, -1TS; Models NBG-10, -10A, -10L, -10P, -10T, -10WP; Models NAR-10, NARA-10, NBG-10SP; Model LNG-1.

**Back boxes**, Models SB-10, SB-I/O, 58BB.

Models **NBG-12**, -12L, -12LA, -12LPS, -12LPSP, -12LR, -12LRA, -12LSP, -12LW, -12LWP, **-12LX**, -12LXBL, -12LXP, -12LXSP, -12NC, **-12PS**, -12S, -12SP, -12W, -12WP, NOT-BG12LX; Models NBG-12LAOB, -12LAO, -12LO, -12LOB, -12LW, -12LWP, -12W, -12WP are for outdoor use when used with a back box as specified in the installation instructions.

(X)Denotes color of box.

[Last Updated](#) on 2009-05-12

[Questions?](#)

[Notice of Disclaimer](#)

[Page Top](#)

[Copyright © 2009 Underwriters Laboratories Inc.®](#)

The appearance of a company's name or product in this database does not in itself assure that products so identified have been manufactured under UL's Follow-Up Service. Only those products bearing the UL Mark should be considered to be Listed and covered under UL's Follow-Up Service. Always look for the Mark on the product.

UL permits the reproduction of the material contained in the Online Certification Directory subject to the following conditions:  
1. The Guide Information, Designs and/or Listings (files) must be presented in their entirety and in a non-misleading manner, without any manipulation of the data (or drawings). 2. The statement "Reprinted from the Online Certifications Directory with permission from Underwriters Laboratories Inc." must appear adjacent to the extracted material. In addition, the reprinted material must include a copyright notice in the following format: "Copyright © 2009 Underwriters Laboratories Inc.®"

# FSP-951 Series

## Intelligent Plug-In Photoelectric Smoke Detectors



Intelligent/Addressable Devices

### General

The NOTIFIER FSP-951 Series intelligent plug-in smoke detectors are designed for both performance and aesthetics. A new modern, sleek, contemporary design and enhanced optical sensing chamber is engineered to sense smoke produced by a wide range of combustion sources in accordance with more stringent code standards. The FSP-951 Series detector sensitivity can be programmed in the control panel software. Sensitivity is continuously monitored and reported to the panel. Point ID capability allows each detector's address to be set with rotary, decimal address switches, providing exact detector location for selective maintenance when chamber contamination reaches an unacceptable level. Dual electronic thermistors add 135°F (57°C) fixed temperature thermal sensing on the FSP-951T. The FSP-951R is a remote test capable detector for use with DNR Series duct detector housings. FSP-951 series detectors are available for both FlashScan® and CLIP applications as designated.

### Features

- New modern profile for improved aesthetics.
- Designed to meet UL268 7th Edition.
- Stable communication technique with noise immunity.
- Low standby current.
- Two-wire SLC connection.
- Compatible with FlashScan® and CLIP protocol systems.
- Rotary, decimal addressing (1-99 on CLIP systems, 1-159 on FlashScan systems).
- Optional remote, single-gang LED accessory.
- Dual LED design provides 360° viewing angle.
- Visible bi-color LEDs blink green every time the detector is addressed, and illuminate steady red on alarm (*FlashScan systems only*).
- Remote test feature from the panel.
- Walk test with address display (an address on 121 will blink the detector LED: 12-[pause]-1 (*FlashScan systems only*)).
- Built-in functional test switch activated by external magnet.
- Built-in tamper-resistant feature.
- Sealed against back pressure.
- Expanded color options.
- SEMS screws for wiring of the separate base.
- Optional relay, isolator, and sounder bases.

### Specifications

#### Sensitivity:

- UL Applications: 0.5% to 4.0% per foot obscuration.
- ULC Applications: 0.5% to 3.5% per foot obscuration.

**Size:** 2.0" (5.3 cm) high; base determines diameter.

- B300-6: 6.1" (15.6 cm) diameter.
- B501: 4" (10.2 cm) diameter.

For a complete list of detector bases see DN-60981.

**Shipping weight:** 3.4oz (96.4g)

#### Operating Temperature range:

- FSP-951, 0°C to 50°C (32°F to 122°F).
- FSP-951T, 0°C to 38°C (32°F to 100°F).



FSP-951 in B300-6 Base

- FSP-951R installed in a DNR/DNRW, -20°C to 70°C (-4°F to 158°F).

**UL/ULC Listed Velocity Range:** 0-4000 ft/min. (1219.2 m/min.), suitable for installation in ducts.

**Relative Humidity:** 10%-93% noncondensing.

**Thermal Ratings:** Fixed-temperature setpoint 135°F (57°C).

#### DETECTOR SPACING AND APPLICATIONS

NOTIFIER recommends spacing detectors in compliance with NFPA 72. In low airflow applications with smooth ceiling, space detectors 30 feet (9.1m). For specific information regarding detector spacing, placement, and special applications refer to NFPA 72. *System Smoke Detector Application Guide*, document A05-1003, is available at [systemsensor.com](http://systemsensor.com)

#### ELECTRICAL SPECIFICATIONS

**Voltage Range:** 15-32 volts DC peak.

**Standby Current (max. avg.):** 200µA @ 24VDC (one communication every five seconds with LED enabled).

**LED Current (max.):** 4.5mA @ 24 VDC ("ON").

### Installation

FSP-951 series plug-in detectors use a separate base to simplify installation, service, and maintenance.

Mount base (all base types) on an electrical backbox which is at least 1.5" (3.81 cm) deep. For a chart of compatible junction boxes, see DN-60981.

**NOTE:** 1) Because of inherent supervision provided by the SLC loop, end-of-line resistors are not required. Wiring "T-taps" or branches are permitted for Style 4 (Class "B") wiring. 2) When using relay or sounder bases, consult the ISO-X(A) installation sheet I56-1380 for device limitations between isolator modules and isolator bases.

## Agency Listings and Approvals

These listings and approvals apply to the detectors specified in this document. In some cases, certain detectors or applications may not be listed by certain approval agencies, or listing may be in process. Consult factory for latest listing status.

- UL/ULC Listed: S911
- FM Approved
- CSFM: 7272-0028:0503

## Product Line Information

### NOTE:

- Detectors must be mounted to one of the Intelligent Bases listed below.
- "A" suffix indicates ULC Listed model.
- "IV" suffix indicates FlashScan® and CLIP device.

**FSP-951:** White, low-profile intelligent photoelectric sensor, FlashScan only.

**FSP-951A:** Same as FSP-951 but with ULC listing.

**FSP-951-IV:** Ivory, low-profile intelligent photoelectric sensor.

**FSP-951A-IV:** Same as FSP-951-IV but with ULC listing.

**FSP-951T:** White, same as FSP-951 but includes a built-in 135°F (57°C) fixed-temperature thermal device. FlashScan only.

**FSP-951TA:** Same as FSP-951T but with ULC listing.

**FSP-951T-IV:** Ivory, same as FSP-951T but includes a built-in 135°F (57°C) fixed-temperature thermal device.

**FSP-951TA-IV:** Same as FSP-951T-IV but with ULC listing.

**FSP-951R:** White, low-profile intelligent photoelectric sensor, remote test capable. For use with DNR/DNRW. FlashScan only.

**FSP-951RA:** Same as FSP-951R but with ULC listing. For use with DNRA.

**FSP-951R-IV:** Ivory, low-profile intelligent photoelectric sensor, remote test capable. For use with DNR/DNRW.

**FSP-951RA-IV:** Same as FSP-951R-IV but with ULC listing. For use with DNRA.

### INTELLIGENT BASES

**NOTE:** For details on intelligent bases, see DN-60981

**B300-6:** White, 6" base, standard flanged low-profile mounting base.

**B300-6-IV:** Ivory, 6" base, standard flanged low-profile mounting base.

**B300A-6:** Same as B300-6, ULC listed.

**B300A-6-IV:** Ivory, 6" standard flanged low-profile mounting base, ULC listed.

**B300-6-BP:** Bulk pack of B300-6, package contains 10

**B501-WHITE:** White, 4" standard European flangeless mounting base. UL/ULC listed.

**B501-BL:** Black, 4" standard European flangeless mounting base. UL/ULC listed.

**B501-IV:** Ivory color, 4" standard European flangeless mounting base. UL/ULC listed.

**B501-WHITE-BP:** Bulk pack of B501-WHITE contains 10.

**B224RB-WH:** White, relay base.

**B224RB-IV:** Ivory, relay base.

**B224RBA-WH:** White, relay base, ULC listing.

**B224RBA-IV:** Ivory, relay base, ULC listing.

**B224BI-WH:** White, *isolator* detector base.

**B224BI-IV:** Ivory *isolator* detector base.

**B224BIA-WH:** White, *isolator* detector base, ULC listing.

**B224BIA-IV:** Ivory *isolator* detector base, ULC listing.

**B200S-WH:** White, Intelligent addressable sounder base capable of producing sound output in high or low volume with ANSI Temporal 3, ANSI Temporal 4, continuous tone, marching tone, and custom tone. Uses FlashScan protocol.

**B200S-IV:** Ivory, Intelligent addressable sounder base capable of producing sound output in high or low volume with ANSI Temporal 3, ANSI Temporal 4, continuous tone, marching tone, and custom tone. Uses FlashScan protocol.

**B200SA-WH:** Same as B200S-WH, ULC listing.

**B200SA-IV:** Same as B200S-IV, ULC listing.

**B200SCOA-WH:** White, Intelligent, programmable sounder base in English/French (required in Canada for ULC applications with SO Series detector applications).

**B200SCOA-IV:** Ivory Intelligent, programmable sounder base in English/French (required in Canada for ULC applications with SO Series detector applications, ULC listing).

**B200S-LF-WH:** White, Low Frequency Intelligent, programmable sounder base. Produces a fundamental frequency of 520 Hz +/- 10% with a square wave or its equivalent; designed to meet the NFPA 72 sleeping space requirement.

**B200S-LF-IV:** Ivory, Low Frequency Intelligent, programmable sounder base. Produces a fundamental frequency of 520 Hz +/- 10% with a square wave or its equivalent; designed to meet the NFPA 72 sleeping space requirement.

**B200SR-WH:** White, Intelligent sounder base capable of producing sound output with ANSI Temporal 3 or continuous tone. Intended for retrofit applications.

**B200SR-IV:** Ivory, Intelligent sounder base capable of producing sound output with ANSI Temporal 3 or continuous tone. Intended for retrofit applications.

**B200SRA-WH:** Same as B200SR-WH with, ULC listing.

**B200SRA-IV:** Same as B200SR-IV in Ivory color, ULC listing.

**B200SR-LF-WH:** White, Low Frequency Intelligent, programmable sounder base. Produces a fundamental frequency of 520 Hz +/- 10% with a square wave or its equivalent; designed to meet the NFPA 72 sleeping space requirement. Intended for retrofit applications.

**B200SR-LF-IV:** Ivory, Low Frequency Intelligent, programmable sounder base. Produces a fundamental frequency of 520 Hz +/- 10% with a square wave or its equivalent; designed to meet the NFPA 72 sleeping space requirement. Intended for retrofit applications.

### MOUNTING KITS AND ACCESSORIES

**TR300:** White, replacement flange for B210LP(A) base.

**TR300-IV:** Ivory, replacement flange for B210LP(A) base.

**RA100Z(A):** Remote LED annunciator. 3 – 32 VDC. Mounts to a U.S. single-gang electrical box. For use with B501(A) and B300(A)-6.

**M02-04-00:** Test magnet.

**M02-09-00:** Test magnet with telescoping handle.

---

©2018 by Honeywell International Inc. All rights reserved. Unauthorized use of this document is strictly prohibited.



---

This document is not intended to be used for installation purposes.  
We try to keep our product information up-to-date and accurate.  
We cannot cover all specific applications or anticipate all requirements.  
All specifications are subject to change without notice.

For more information, contact Notifier. Phone: (800) 627-3473, FAX: (203) 484-7118.  
[www.notifier.com](http://www.notifier.com)



**UL Product iQ**  
 UL'S NEXT GENERATION CERTIFICATIONS SEARCH  
 The same trusted data in a modern search engine.

**NOW  
 AVAILABLE**

**▶ LEARN MORE**

## UROX.S1115 Smoke Detectors for Fire Alarm Systems

[Page Bottom](#)

### Smoke Detectors for Fire Alarm Systems

[See General Information for Smoke Detectors for Fire Alarm Systems](#)

#### NOTIFIER

12 Clintonville Rd  
 Northford, CT 06472-1610 USA

S1115

Detector Model	Application	Type	Compatibility Restrictions	Velocity Range (fpm)		Date of Manufacture	Time of Manufacture Firmware Version	Firmware Version Update
				Min	Max			
CP-651	OAP, RS	I	D2	0	1200	-	-	-
CPX551B	OAP	I	D1	0	1500	-	-	-
DSA-04L, DSA-24L	D(I)	P	None	0	300	-	-	-
FAPT-851C	OAP, D(I)	P(IHD)	D2	0	4000	-	-	-
FCO-851 (CO)	OAP	P(IHD)	D4	0	4000	-	-	-
FSB-200, FSB-200S, JTY-H-FSB-200S	OAP	PB	D2			-	-	-
FSC-851	OAP	P(IHD)	D4	0	4000	-	-	-
FSH-751	OAP, D(I)	P	D1	0	4000	-	-	-
FSI-851	OAP	I	D2	0	1200	-	-	-
FSL-751 (b), FSL-751E (b)	OAP	Laser	None			-	-	-
<b>FSP-851, FSP-851-BR, JTY-GD-FSP-851C, JTY-GD-FSP-851, FSP-851R</b>								
	OAP, D(I)	P	D2	0	4000	-	-	-
FSP-851T, FAPT-851	OAP, D(I)	P(IHD)	D2	0	4000	-	-	-

**FSP-951 (g)(i), FSP-951R (g)(i), NP-200 (g)(i), NP-200R (g)(i)**

	OAP, D(I)	P	D2	0	4000	-	-	-
<b>FSP-951T (g)(h), FSP-951T-ISO (g)(h), NP-200T (g)(h)</b>								
	OAP, D(I)	P	D2	0	4000	-	-	-
<b>FSV-951 (i)(l), FSV-951-IV (i)(l), FSV-951C (i)(l), FSV-951R (i)(l), FSV-951R-IV (i)(l), FSV-951RC (i)(l)</b>								
	OAP, D(I)	P	D2	0	4000	-	-	-
<b>FWD-200ACCLIMATE</b>	OAP	P(RF)	D2	0	4000	-	-	-
<b>FWD-200P</b>	OAP	P(RF)	D2	0	4000	-	-	-
<b>FWD-200PT</b>	OAP	P(RF)(IHD)	D2	0	4000	-	-	-
<b>HPX751</b>	OAP	P	D1	0	300	-	-	-
<b>JTF-YW-FSP-851TC</b>	OAP, D(I)	P(IHD)	D2	0	4000	-	-	-
<b>JTY-GD-FSP-951G</b>	OAP	P	D2	0	300	-	-	-
<b>LPX751L</b>	OAP, D(I)	P	D2	0	4000	-	-	-
<b>N124C, N125C</b>	OAP, D(I)	P	D1	400	4000	-	-	-
<b>NDH, NDH-10</b>	D(ST)	P	None	500	4500	-	-	-
<b>NH-241</b>	OAP	I	D1	0	1500	-	-	-
<b>NI-100</b>	OAP	I	D2	0	300	-	-	-
<b>NP-100, NP-100R</b>	OAP, D(I)	P	D2	0	4000	-	-	-
<b>NP-A100</b>	OAP	P(IHD)	D2	0	4000	-	-	-
<b>NSD, NCP, NSDH, NCPH</b>	OAP, RS	P	None	0	300	-	-	-
<b>NSD-1, NSDH-1</b>	OAP	P	None	0	300	-	-	-
<b>NSD-2W, NSDH-2W</b>	OAP, RS	P	D1	0	300	-	-	-
<b>SD-651</b>	OAP, D(I)	P	D2	0	3000	-	-	-
<b>SDRF-751, SDRF-751S</b>	OAP	P(RF)	D2	0	300	-	-	-
<b>SDX-551B</b>	OAP, D(I)	P	D2	0	3000	-	-	-
<b>SDX-751 (b)</b>	OAP, D(I)	P	None	300	4000	-	-	-
<b>SIF-24</b>	OAP	I	D1	0	300	-	-	-

Detector	Application	Type	Compatibility	Velocity Range (fpm)		Pressure Differential Between Sampling Tube		Date of Manufacture	Time of Manufacture	Firmware Version
				Min	Max	Min	Max			
Model	Application	Type	Restrictions	Min	Max	Min	Max	Manufacture	Firmware Version	Update

<b>FSL-751D (w. FSL-751 head)</b>	D(ST)	I	D2	500	4000	0.05	1	-	-	-
<b>FSD-751P, FSD-751RP</b>	D(ST)	P	D2	500	4000	0.03	1.4	-	-	-
<b>FSD-751PL</b>	D(ST)	P	D2	100	4000	0.03	1.4	-	-	-
<b>FSD-751RPL (a)</b>	D(ST)	P	D2	100	4000	0.03	1.4	-	-	-
<b>NP-100T</b>	OAP, D(ST), D(I)	P	D2	100	4000	0.03	1.4	-	-	-
<b>DHX-502 (b) w. 1551 head</b>	D(ST)	I	D2	500	4000	0.01	1.2	-	-	-
<b>DHX-502 (b) w. 2551 head</b>	D(ST)	P	D2	500	4000	0.01	1.2	-	-	-
<b>DHX-502 (b) w. 7251 head</b>	D(ST)	Laser	D2			0.01	1.2	-	-	-
<b>FSL-751DNR</b>	D(ST)	P	D2	300	4000	0.01	1.11	-	-	-
<b>ND-200 (c)(d)</b>	D(ST)	P	D2	100	4000	0.01	1.11	-	-	-

Base Model	Related Detector	Control Unit Compatibility Restrictions
<b>B-501, B501BH, B710LP</b>	CPX-751, FS1-851, SDX-751, LPX-751L	B2
<b>B200S (j), B200S-LF (j), B200SR (j), B200SR-LF (j), B210LP, B224BI (j), B224RB (j), B300-6 (j), B300-6-IS (j), B501 (j)(k), B710LP</b>		
	FSP-951, FSP-951R, FSP-951T, FSP-951T-ISO, NP-200, NP-200R, NP-200T, FSV-951, FSV-951-IV, FSV-951C, FSV-951R, FSV-951R-IV, FSV-951RC	B4
<b>B210LP, B210LP-BR</b>	1251, 2251, 3251, 7251, FCO-851	B2
<b>B401, B110LP, B110RLP, B112LP, B114LP(RS), (BT), B116LP(RS), B401BH, B401B, B401LP, B401R, B402B, B404B, B404BT, B406B, B710LP</b>		
	1151, 1151EIS, 2151	B2
<b>B401, B401B, B401BH, B401BR, B401R</b>	1451, 2451, 2451TH, JTY-GD-2451	B2
<b>B501(k), B200S(j), B210LP, B224RB(j), B224BI(j)</b>		
	FSC-851, FCO-851	B4
<b>B501B-FTX</b>	FTX-P1 Filtrex	B2
<b>B501BH-2, B501BHT-2, B406B(RS), B501(k), B501B</b>		
	1451, 2451, 2451TH, 1551, 2551	B2
<b>B501BH-3 (e) (f)</b>	FSC-851, FSI-851, FSP-851, FSP-851T, FST-851, FST-851R, FST-851H, FAPT-851, FSL-751, SDX-751CH, FDX-551CH, HFS-P	B4
<b>B610LP, B612LP (RS), B614LP (RS), B616LP (RS), B710HD</b>		

	2151, 2151T, 1151, 5451, 1151EIS, 1451, CP-651, SD-651	B2
<b>B710HD</b>	FSH-751, H2351ADT, HPX-751	B1
<b>B901G</b>	-	None

B1 - Listing limited to specific system control unit. Information on compatible control unit indicated on installation drawing of control unit and/or detector.

B2 - For connection to Listed control units with which compatibility was determined by test or a review of circuit parameters. Interconnection and compatible models indicated on installation wiring diagram for detector (base) and/or control unit.

B4 - For connection to any manufacturer's Listed compatible control unit.

D1 - Listing limited to specific system control unit. Information on compatible control unit indicated on installation drawing of control unit and/or detector.

D2 - For connection to Listed control units with which compatibility was determined by test or a review of circuit parameters. Interconnection and compatible models indicated on installation wiring diagram for detector (base) and/or control unit.

D4 - For connection to any manufacturer's Listed compatible control unit.

OAP - Open Area Protection

RS - Releasing Service

I - Ionization

D(I) - Duct Detector - Installation Inside Duct

P - Photoelectric

IHD - Includes Integral Heat Detector

PB - Projected Beam

RF - Includes Integral Radio Frequency Transmitter

D(ST) - Duct Detector - Sampling Tubes

**Date of Manufacture** identifies the manufacturing start date of all product models that will use the specific Time of Manufacture Firmware Version. The date of manufacture is noncoded and in the format YEAR (in 4 digits), MONTH (in letters), DAY (in 2 digits).

**Time of Manufacture Firmware Version** identifies a numerical and/or alphabetic series designation that is product and date-code specific and will only identify the Firmware Version at the time the product was manufactured. The numeric and/or alphabetic sequence is defined by the manufacturer.

**Firmware Version Update** is a numerical and/or alphabetic sequential identification that is product and date-code specific and sequentially identifies the Firmware Version Update from the previous version of firmware. The numerical and/or alphabetic sequence is defined by the manufacturer.

(a) - Suitable for use in ambient temperatures of 0-55 C (23-131 F).

(b) - Special application.

(c) - Suitable for elevated temperatures up to 70 C

(d) - ND-200 duct housing can be used with the following compatible detector heads: NP-100, NP-100R

(e) - Complimentary listed to UL 464 (ULSZ).

(f) - Suitable for use in ambient temperatures of -20 to 49 C (-4 to 120 F)

(g) - Model number may be followed by a two digit suffix, indicating the color of the detector's enclosure: no suffix for white, -IV for ivory, -BL for black, etc.

(h) - Complimentary listed to UL 521 (UQGS).

(i) - Suitable for use in ambient temperatures of 0-50 C (32-122 F).

(j) - Model number may be followed by a two digit suffix, indicating the color of the enclosure: -WH for white, -IV for ivory, -BL for black, etc.

(k) - Model number may be followed by a suffix, indicating the color of the enclosure: -WHITE for white, -IV for ivory, -BL for black, etc.

(l) - Suitable for use in Special Application installations with system sensitivity setting between 0.02 and 0.5 percent per foot obscuration.

CO - Suitable for use as a carbon monoxide alarm

Last Updated on 2018-07-11

---

[Questions?](#)

[Print this page](#)

[Terms of Use](#)

[Page Top](#)

© 2018 UL LLC

The appearance of a company's name or product in this database does not in itself assure that products so identified have been manufactured under UL's Follow-Up Service. Only those products bearing the UL Mark should be considered to be Certified and covered under UL's Follow-Up Service. Always look for the Mark on the product.

UL permits the reproduction of the material contained in the Online Certification Directory subject to the following conditions: 1. The Guide Information, Assemblies, Constructions, Designs, Systems, and/or Certifications (files) must be presented in their entirety and in a non-misleading manner, without any manipulation of the data (or drawings). 2. The statement "Reprinted from the Online Certifications Directory with permission from UL" must appear adjacent to the extracted material. In addition, the reprinted material must include a copyright notice in the following format: "© 2018 UL LLC".



# L-Series and L-Series with LED Indoor Selectable Horns, Strobes and Horn Strobes

*System Sensor L-Series and L-Series with LED audible visible notification products are rich with features guaranteed to cut installation times and maximize profits with lower current draw and modern aesthetics.*



## Features

- LED technology provides lower current draw
- Digital Voltage Meter (DVM) diagnostic test points for Horn Strobes and Strobes
- Common aesthetics across the L-Series platform
- Standard and compact sizes
- Tamper-resistant construction
- Field-selectable candela settings on wall units: 15, 30, 75, 95, 110, 135, and 185
- Field-selectable candela settings on ceiling units: 15, 30, 75, 95, 115, 150, and 177
- Rotary switches for candela, tone and volume selections
- Mounting plate provides plug-in design for easier installation and shorting springs to check wiring continuity
- Electrically compatible with legacy SpectrAlert, SpectrAlert Advance and L-series devices
- Synchronization through use of UL approved power supplies that support System Sensor Sync protocol or System Sensor MDL3 Sync Module
- Horns, Strobes and Horn Strobes listed for wall or ceiling use

## The System Sensor L-Series and L-Series with LED

**platform** offers the most versatile and easy-to-use line of horns, strobes, and horn strobes in the industry with lower current draw and modern aesthetics. LED lighting technology offers significantly lower current draw compared to older Xenon bulbs across a full candela range. This improves design flexibility for notification appliance circuits (NACs) while also reducing power supply requirements allowing for simpler and lower cost installations.

Flexible design options meet virtually any application requirement: wall or ceiling mount, standard or compact sizes, red or white color choices, bezel kits for alternate markings and languages, and LED color lenses for distinctive visual signaling. In addition, installers can easily adapt devices using field selectable candela, tone and volume settings using rotary switches.

The L-Series and L-Series with LED line is developed to simplify installation. All devices feature plug-in designs with minimal intrusion into the back box, making installations fast and foolproof while virtually eliminating costly and time-consuming ground faults. The universal mounting plate includes an onboard shorting spring, so installers can test wiring continuity before the device is installed.

In addition, the System Sensor L-Series with LED notification appliances offer a new diagnostic test point feature that allows you to measure device voltage with a digital voltage meter (DVM) without removing the appliance from the wall or ceiling. The DVM test points are discreetly located on the face of the notification appliance which enable faster troubleshooting and end of line (EOL) voltage checks while greatly reducing the risk of misplacing or damaging appliances during troubleshooting.

## Agency Listings

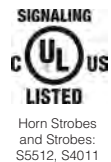

## L-Series and L-Series with LED Specifications

Physical/Electrical Specifications	
Standard Operating Temperature	32°F to 120°F (0°C to 49°C)
Humidity Range	10 to 93% non-condensing
Strobe Flash Rate	1 flash per second
Nominal Voltage, LED Strobes and Horn Strobes	Regulated 24 VDC
Nominal Voltage, Horns	Regulated 12 VDC or regulated 24 DC/FWR
Operating Voltage Range, LED Strobes and Horn Strobes	16 to 33 V (24 V nominal)
Operating Voltage Range, Horns	8 to 17.5 V (12 V nominal) or 16 to 33 V (24 V nominal)
Input Terminal Wire Gauge	12 to 18 AWG

## UL/ULC Current Draw Data, Horn Tones, and Sound Output Data

UL/ULC Maximum Strobe Current Draw (mA)			
Candela Range	Candela Rating	16–33 Volts	
		Wall	Ceiling
Candela Range	15	18	18
	30	22	22
	75	70	70
	95	75	75
	110	85	—
	115	—	90
	135	105	—
	150	—	110
	177	—	115
	185	120	—

UL/ULC Maximum Horn Current Draw (mA RMS)				
Sound Pattern	dB	8–17.5 Volts		
		DC	DC	FWR
Temporal	High	39	44	54
Temporal	Low	28	32	54
Non-Temporal	High	43	47	54
Non-Temporal	Low	29	32	54
3.1 KHz Temporal	High	39	41	54
3.1 KHz Temporal	Low	29	32	54
3.1 KHz Non-Temporal	High	42	43	54
3.1 KHz Non-Temporal	Low	28	29	54
Coded	High	43	47	54
3.1 KHz Coded	High	42	43	54

UL/ULC Maximum Horn Strobe Current Draw (mA) and Sound Output (dBA)														
Switch Pos.	Sound Pattern	Volume Setting	Current Draw (mA RMS), Horn Strobe, Candela Range (15-185 cd)										Sound Output (dBA)	
			16-33 Volts											16-33V DC
			15cd	30cd	75cd	95cd	110cd	115cd	135cd	150cd	177cd	185cd		
			WALL	CEILING	WALL	CEILING	WALL	CEILING	CEILING	WALL				
1	Temporal 3	High	35	38	87	92	94	120	189	189	190	190	87	
2	Temporal 3	Low	35	38	87	92	94	120	135	135	145	145	79	
3	Non-Temporal	High	50	52	87	92	94	120	127	127	135	135	87	
4	Non-Temporal	Low	35	38	87	92	94	120	125	125	130	130	79	
5	3.1KHz Temporal 3	High	35	38	87	89	91	115	155	155	165	165	86	
6	3.1KHz Temporal 3	Low	35	38	87	89	91	115	128	130	135	135	80	
7	3.1KHz Non-Temporal	High	40	42	87	89	91	115	125	125	135	135	86	
8	3.1KHz Non-Temporal	Low	35	38	87	89	91	115	120	120	130	130	80	

## L-Series with LED Dimensions: Wall-Mounted Equipment

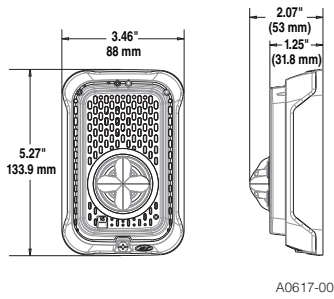

A0617-00

**Compact Strobe, Horn Strobe  
for Wall**

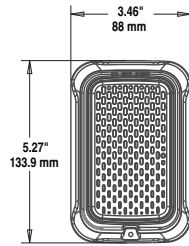

A0547-00

**Compact Horn**

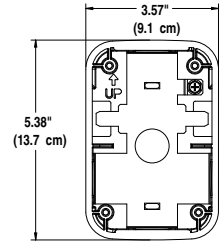
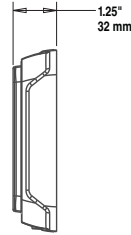

A0557-00

**Compact Surface Mount Back Box  
for Walls (SBBGRL, SBBGWL)**

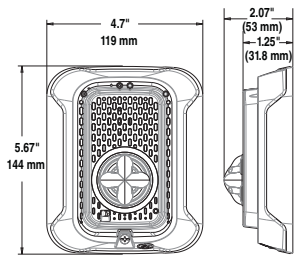

A0613-00

**Strobes, Horn Strobes  
for Walls**

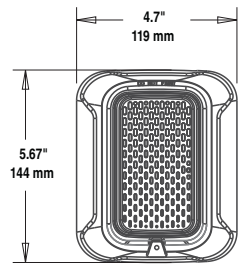

A0549-00

**Horn**

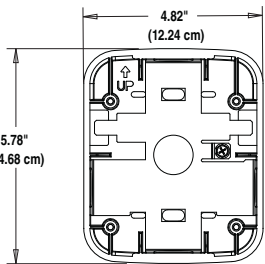
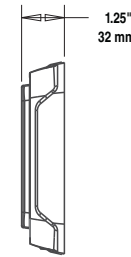

A0554-01

**Surface Mount Back Box  
for Walls (SBBRL/SBBWL)**

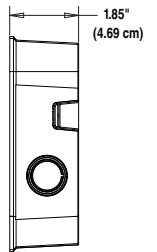

## L-Series with LED Dimensions: Ceiling-Mounted Equipment

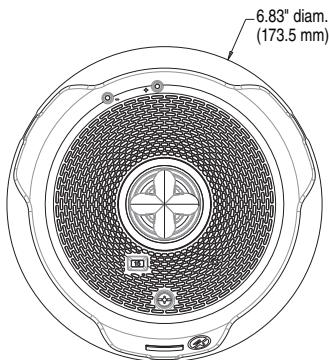

A0608-00

**Strobes and Horn Strobes  
for Ceilings**

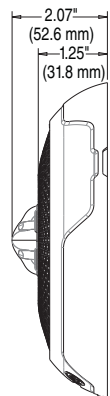

6.92" diam.  
(175.77 mm)

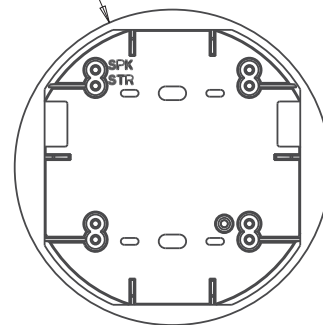

A0546-00

**Surface Mount Back Box  
for Ceilings (SBBCRL, SBCWL)**

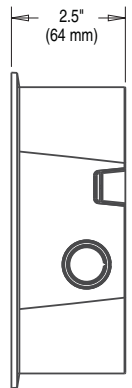

## L-Series with LED: Ordering Information

Model	Description
<b>L-Series with LED Horn Strobes</b>	
P2RLED	2-Wire, Horn Strobe, Wall, Red
P2RLED-B	2-Wire, Horn Strobe, Wall, Red, Bilingual
P2WLED	2-Wire, Horn Strobe, Wall, White
P2WLED-B	2-Wire, Horn Strobe, Wall, White, Bilingual
P2GRLED	2-Wire, Compact Horn Strobe, Wall, Red
P2GRLED-B	2-Wire, Compact Horn Strobe, Wall, Red, Bilingual
P2GWLED	2-Wire, Compact Horn Strobe, Wall, White
P2GWLED-B	2-Wire, Compact Horn Strobe, Wall, White, Bilingual
P2RLED-P	2-Wire, Horn Strobe, Wall, Red, Plain
P2WLED-P	2-Wire, Horn Strobe, Wall, White, Plain
P2RLED-SP	2-Wire, Horn Strobe, Wall, Red, FUEGO
P2WLED-SP	2-Wire, Horn Strobe, Wall, White, FUEGO
PC2RLED	2-Wire, Horn Strobe, Ceiling, Red
PC2RLED-B	2-Wire, Horn Strobe, Ceiling, Red, Bilingual
PC2WLED	2-Wire, Horn Strobe, Ceiling, White
PC2WLED-B	2-Wire, Horn Strobe, Ceiling, White, Bilingual
<b>L-Series with LED Strobes</b>	
SRLED	Strobe, Wall, Red
SRLED-B	Strobe, Wall, Red, Bilingual
SWLED	Strobe, Wall, White
SWLED-B	Strobe, Wall, White, Bilingual
SGRLED	Strobe, Compact, Wall, Red
SGRLED-B	Strobe, Compact, Wall, Red, Bilingual
SGWLED	Strobe, Compact, Wall, White
SGWLED-B	Strobe, Compact, Wall, White, Bilingual
SRLED-P	Strobe, Wall, Red, Plain
SWLED-P	Strobe, Wall, White, Plain
SRLED-SP	Strobe, Wall, Red, FUEGO
SWLED-CLR-ALERT	Strobe, Wall, White, ALERT
SWLED-ALERT	Strobe, Wall, White, ALERT, Amber Lens
SCRLED	Strobe, Ceiling, Red
SCRLED-B	Strobe, Ceiling, Red, Bilingual
SCRLED-P	Strobe, Ceiling, White, Plain
SCWLED	Strobe, Ceiling, White
SCWLED-B	Strobe, Ceiling, White, Bilingual
SCWLED-P	Strobe, Ceiling, White, Plain
SCWLED-CLR-ALERT	Strobe, Ceiling, White, ALERT
<b>L-Series Horns</b>	
HRL*	Horn, Red
HRLA*	Horn, Red, Plain, ULC
HWL*	Horn, White
HWLA*	Horn, White, Plain, ULC
HGRL*	Compact Horn, Red
HGRLA*	Compact Horn, Red, Plain, ULC
HGWL*	Compact Horn, White
HGWLA*	Compact Horn, White, Plain, ULC

Model	Description
<b>LED Lenses</b>	
LENS-A3	Lens LED Amber Wall/Ceiling
LENS-B3	Lens LED Blue Wall/Ceiling
LENS-G3	Lens LED Green Wall/Ceiling
LENS-R3	Lens LED Red Wall/Ceiling
<b>Accessories</b>	
TR-2	Universal Wall Trim Ring Red
TR-2W	Universal Wall Trim Ring White
SBBRL	Wall Surface Mount Back Box, Red
SBBWL	Wall Surface Mount Back Box, White
SBBGRL	Compact Wall Surface Mount Back Box, Red
SBBGWL	Compact Wall Surface Mount Back Box, White
TRC-2	Universal Ceiling Trim Ring, Red
TRC-2W	Universal Ceiling Trim Ring, White
SBBCRL	Ceiling Surface Mount Back Box, Red
SBBCWL	Ceiling Surface Mount Back Box, White
<b>Bezels†</b>	
BZR	Wall Red Bezel Kit
BZW	Wall White Bezel Kit
BZGR	Compact Wall Red Bezel Kit
BZGW	Compact Wall White Bezel Kit
BZRC	Horn Strobe Ceiling Red Bezel Kit
BZWC	Horn Strobe Ceiling White Bezel Kit

### Notes for L-Series With LED Horn Strobes and Strobes:

All -P models have a plain housing (no "FIRE" marking on cover).  
 All -SP models have "FUEGO" marking on cover.  
 All -ALERT models have "ALERT" marking on cover.  
 All -B models have "FIRE/FEU" marking on cover for use in Canadian applications.  
 Amber lenses are not for use in Canadian applications

### Notes for L-Series Horns:

\*Horn-only models are listed for wall or ceiling use.

### Notes for Bezels:

†Each bezel pack ships in a package of 5.  
 Add one of the following extensions for print/language options: -F (FIRE), -AL (ALERT), -EV (EVAC), -AG (AGENT), -P (Plain), -FR (FEU), -PG (FOGO), -SP (FUEGO), -SPE (FUEGO/FIRE).

3825 Ohio Avenue • St. Charles, IL 60174 USA  
 Phone: 800-SENSOR2 • Fax: 630-377-6495  
[www.systemsensor.com](http://www.systemsensor.com)

3333 Unity Drive, Mississauga, ON L5L 3S6 Canada  
 Phone: 800-SENSOR2 • Fax: 905-812-0771  
[www.systemsensor.ca](http://www.systemsensor.ca)

System Sensor® is a registered trademark of Honeywell International, Inc.



©2023 System Sensor.  
 Product specifications subject to change without notice. Visit [www.systemsensor.com](http://www.systemsensor.com) for current product information, including the latest version of this data sheet.  
 AVDS916-01 • 10/03/2023

# Signaling Appliances and Equipment for the Hearing Impaired

## COMPANY

System Sensor Unincorporated, Div of Honeywell International Inc

3825 Ohio Ave

Saint Charles, IL 60174-5467 United States

S5512

**Ceiling Tile Strobe for indoor dry/damp use** Model(s) SCWL(A)-TILE\*

**Strobe light accessories, colored lens, for private mode signaling use** Model(s) LENS-A2, LENS-AC2, LENS-B2, LENS-BC2, LENS-G2, LENS-GC2, LENS-R2, LENS-RC2

**Strobe lights with low frequency sounder** Model(s) P2RH-LF, P2WH-LF

**Strobe lights, synchronous type** Model(s) SCRKLED, SCRKLED-P, SCRKLED-B, SCWKLED, SCWKLED-P, SCWKLED-B (a) (b)

**Strobe lights, synchronous type** Model(s) SCRL(A)\*, SCWL(A)\*, SCWL-CLR-ALERT\*

**Strobe lights, synchronous type** Model(s) SGRKLED, SGRKLED-P, SGRKLED-B, SGWKLED, SGWKLED-P, SGWKLED-B (a) (b)

**Strobe lights, synchronous type** Model(s) SGRL(A)\*, SGWL(A)\*, SRL(A)\*, SRL(A)-P\*, SRL-SP\*

**Strobe lights, synchronous type** Model(s) SRLED, SWLED, SRLED-B, SWLED-B, SRLED-P, SWLED-P, SRLED-SP, SWLED-SP, SWLED-CLR-ALERT, SCRLED, SCWLED, SCRLED-B, SCWLED-B, SCRLED-P, SCWLED-P, SCWLED-CLR-ALERT, SGRLED, SGWLED, SGRLED-B, SGWLED-B,

**Strobe lights, synchronous type** Model(s) SWL(A)\*, SWL(A)-P\*, SWL-ALERT\*, SWL-CLR-ALERT\*

**Strobe lights, synchronous type, when used with the MDL Synchronization Protocol, 135, 150, 177 or 185 cd, round shape enclosure, for indoor use on wall or ceiling** Model(s) SCR, SCR-P, SCR-PG, SCR-SP, SCRH, SCRH-P, SCRH-PG, SCRH-SP, SCW, SCW-CLR-ALERT, SCW-CLR-ALERT-P, SCW-CLR-ALERT-PG, SCW-CLR-ALERT-SP, SCW-P, SCW-PG, SCW-SP, SCWH, SCWH-P, SCWH-PG, SCWH-SP

**Strobe lights, synchronous type, when used with the MDL Synchronization Protocol, 15, 15/75, 30, 75, 95, 110, or 115 cd, rectangular shape enclosure, for indoor use on wall or ceiling** Model(s) SR, SR-P, SR-PG, SR-SP, SRH, SRH-P, SRH-PG, SRH-SP, SW, SW-CLR-ALERT, SW-CLR-ALERT-P, SW-CLR-ALERT-PG, SW-CLR-ALERT-SP, SW-P, SW-PG, SW-SP, SWH, SWH-P, SWH-PG, SWH-SP

**Visual signal appliance accessories, accessory back box skirt cover** Model(s) SPSEP-BBSWL

**Visual signal appliance accessories, accessory retrofit trim plate** Model(s) RFP+, RFPW+

**Visual signal appliance accessories, accessory strobe expander plate** Model(s) SEP-SPSWL, SEP-SPSWL-P

**Visual signal appliance accessories, accessory trim ring** Model(s) TR-HS+, TRC-HS+, TRCW-HS+, TRW-HS+

(a) - Intended for outdoor wet use

(b) - Rated Type 4X and IP56 as standalone devices (without the backbox)

\* - Where A suffix Canadian models may have added suffixes -E for English, -F for French, -P for plain versions with no wording.

+ - Optional with Series SR, Series SW, Series SCR or Series SCW synchronous type strobe lights.

Last Updated on 2024-09-03

The appearance of a company's name or product in this database does not in itself assure that products so identified have been manufactured under UL Solutions' Follow - Up Service. Only those products bearing the UL Mark should be considered to be Certified and covered under UL Solutions' Follow - Up Service. Always look for the Mark on the product.

UL Solutions permits the reproduction of the material contained in Product iQ subject to the following conditions: 1. The Guide Information, Assemblies, Constructions, Designs, Systems, and/or Certifications (files) must be presented in their entirety and in a non-misleading manner, without any manipulation of the data (or drawings). 2. The statement "Reprinted from Product iQ with permission from UL Solutions" must appear adjacent to the extracted material. In addition, the reprinted material must include a copyright notice in the following format: "©2024 UL LLC."



# Indoor Selectable-Output Speaker Strobes and Dual Voltage Evacuation Speakers for Wall Applications

*System Sensor L-Series selectable output speaker strobes and dual-voltage evacuation speakers can reduce ground faults and enable faster installation with lower current draw and modern aesthetics.*

## Features

- Plug-in design and protective cover reduce ground faults
- Universal mounting plate with an onboard shorting spring tests wiring continuity before installation
- No extension ring required
- Field selectable candela settings on wall units: 15, 30, 75, 95, 110, 135, 185
- Automatic selection of 12- or 24-volt operation at 15 and 30 candela
- Rotary switch simplifies field selection of speaker voltage (25 and 70.7 Vrms) and power settings (1/4, 1/2, 1 and 2 watts)
- Speakers offer high fidelity and high volume sound output
- Compatible with System Sensor synchronization protocol
- Electrical compatibility with existing SpectrAlert and SpectrAlert Advance products
- Tamper-resistant construction
- Updated modern aesthetics

## Agency Listings



FM approved except for ALERT models 3057493



7320-1663:0505



**The System Sensor L-Series** of speakers and speaker strobes reduce costly ground faults using a plug-in design and universal mounting plate that allow the installer to pre-wire mounting plates, dress the wires, and confirm wiring continuity before plugging in the speakers. In addition, a protective plastic cover prevents nicked wires by covering exposed speaker components.

These devices also enable faster installations by providing instant feedback to ensure that wiring is properly connected, rotary switches to select voltage and power settings, and 7 field-selectable candela settings for wall speaker strobes.

The low total harmonic distortion of the speaker offers high fidelity sound output while still offering high volume sound output for use in high ambient noise applications.

### System Sensor L-Series makes installation easy

- Attach a universal mounting plate to a 4 × 4 × 21/8 inch back box. Flush-mount applications do not require an extension ring.
- Connect the notification appliance circuit or speaker wiring to the terminals on the mounting plate.
- Attach the speaker or speaker strobe to the mounting plate by inserting the product tabs into the mounting plate grooves. Hinge the device into position to lock the product pins into the mounting plate terminals. The device will temporarily hold in place with a catch until it is secured with a captured mounting screw.

# L-Series Speaker and Speaker Strobe Specifications

## Architectural/Engineering Specifications

### General

L-Series speaker and speaker strobes shall mount to a 4 × 4 × 2 1/8-inch back box. A universal mounting plate shall be used for mounting ceiling and wall products. The notification appliance circuit and amplifier wiring shall terminate at the universal mounting plate. Also, L-Series speaker strobes, when used with the Sync•Circuit™ Module accessory, shall be powered from a non-coded notification appliance circuit output and shall operate on a nominal 12 or 24 volts. When used with the Sync•Circuit Module, 12-volt rated notification appliance circuit outputs shall operate between 8.5 and 17.5 volts; 24-volt rated notification appliance circuit outputs shall operate between 16.5 and 33 volts. Indoor L-Series products shall operate between 32°F and 120°F from a regulated DC, or full-wave rectified, unfiltered power supply. Wall-mount speaker strobes shall have field-selectable candela settings including 15, 30, 75, 95, 110, 135, 185.

### Speaker

The speaker shall be a System Sensor L-Series model \_\_\_\_\_ dual-voltage transformer speaker capable of operating at 25.0 or 70.7 nominal Vrms. It should be listed to UL 1480 and shall be approved for fire protective service. The speaker shall have a frequency range of 400 to 4,000 Hz and shall have an operating temperature between 32°F and 120°F. The speaker shall have power taps and voltage that are selected by rotary switches.

### Speaker Strobe combination

The speaker strobe shall be a System Sensor L-Series model \_\_\_\_\_ listed to UL1480 and UL 1971 and be approved for fire protective signaling systems. The speaker shall be capable of operating at 25.0 or 70.7 nominal Vrms selected via rotary switch, and shall have a frequency range of 400 to 4,000 Hz. The speaker shall have power taps that are selected by rotary switch. The strobe shall comply with the NFPA 72 requirements for visible signaling appliances, flashing at 1 Hz over the strobe's entire operating voltage range. The strobe light shall consist of a xenon flash tube and associated lens/reflector system.

### Synchronization Module

The module shall be a System Sensor Sync•Circuit model MDL3 listed to UL 464 and shall be approved for fire protective service. The module shall synchronize SpectrAlert strobes at 1 Hz. The module shall mount to a 4 1/16 × 4 1/16 × 2 1/8-inch back box. The module shall also control two Style Y (class B) circuits or one Style Z (class A) circuit. The module shall synchronize multiple zones. Daisy chaining two or more synchronization modules together will synchronize all the zones they control. The module shall not operate on a coded power supply.

## Physical Specifications

<b>Operating Temperature</b>	32°F to 120°F (0°C to 49°C)		
<b>Humidity Range</b>	10 to 93% non-condensing		
<b>Dimensions, Wall-Mount</b>	<b>Length</b>	<b>Width</b>	<b>Depth</b>
<b>SPL Speaker</b>	6.5 in, 165 mm	5 in, 127 mm	.97 in, 23 mm
<b>With Surface Mount Back Box</b>	6.6 in, 168 mm	5.1 in, 130 mm	3.2 in, 82 mm
<b>SPSL Speaker/Strobe (including lens and speaker)</b>	6.5 in, 165 mm	5.0 in, 127 mm	2.3 in, 58 mm
<b>With Surface Mount Back Box</b>	6.6 in, 168 mm	5.1 in, 130 mm	4.5 in, 116 mm

## Electrical/Operating Specifications

<b>Nominal Voltage (speakers)</b>	25 Volts or 70.7 Volts(nominal)
<b>Maximum Supervisory Voltage (speakers)</b>	50 VDC
<b>Strobe Flash Rate</b>	1 flash per second
<b>Nominal Voltage (strobes)</b>	Regulated 12 VDC or regulated 24 DC/FWR <sup>1,2</sup>
<b>Operating Voltage Range (includes fire alarm panels with built in sync)</b>	8 to 17.5 V (12 V nominal) or 16 to 33V (24 V nominal)
<b>Operating Voltage with MDL3 Sync Module</b>	8.5 to 17.5 V (12 V nominal) or 16.5 to 33V (24 V nominal)
<b>Frequency Range</b>	400 to 4000 Hz
<b>Power</b>	1/4, 1/2, 1, 2 watts

1. Full Wave Rectified (FWR) voltage is a non-regulated, time-varying power source that is used on some power supply and panel outputs.

2. Strobe products will operate at 12 V nominal only for 15 and 30 cd

## UL Current Draw Data

UL Max Strobe Current Draw (mA RMS)				
	8 to 17.5 Volts		16 to 33 Volts	
Candela	DC		DC	FWR
15	88		43	60
30	143		63	83
75	N/A		107	136
95	N/A		121	155
110	N/A		148	179
135	N/A		172	209
185	N/A		222	257

  

Sound Output Speaker Strobe				
	¼ W	½ W	1 W	2 W
UL Reverberant (dBA @10 ft)	77	80	83	86
UL Anechoic (dBA @10 ft)	77	80	83	86

Sound Output Speaker				
	¼ W	½ W	1 W	2 W
UL Reverberant (dBA @10 ft)	79	82	85	88
UL Anechoic (dBA @10 ft)	79	82	85	88

## L-Series Dimensions

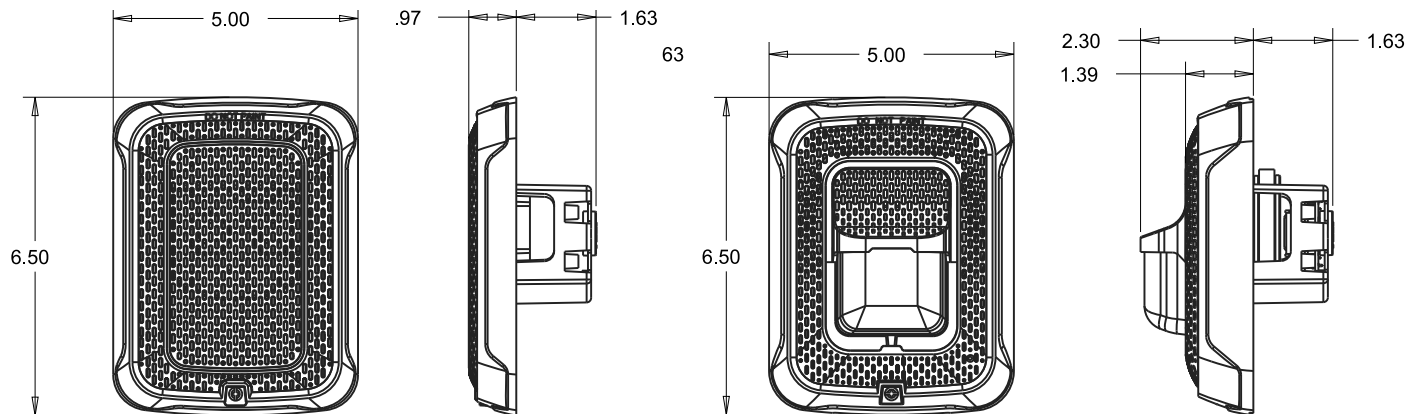

Wall-Mount Speaker

Wall-Mount Speaker Strobe

## Surface Mounting

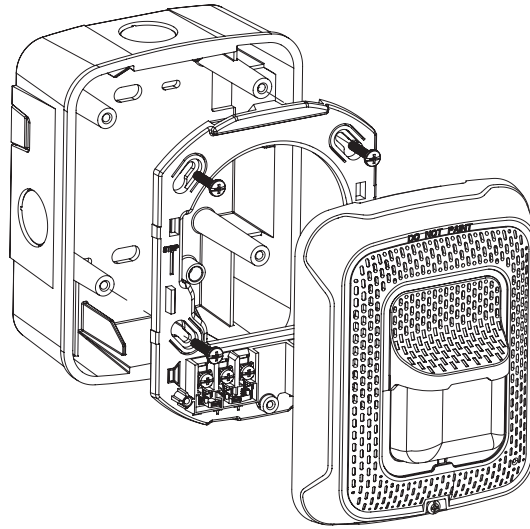

Wall-Mount Speaker Strobe with SBBSPW Surface Mount Back Box

### L-Series Ordering Information

Wall Mount		
White	Red	Description
SPWL	SPRL	Speaker only
SPSWL	SPSRL	Speaker Strobe
SPSWL-P	SPSRL-P	Plain Speaker Strobe
SPSWL-ALERT	—	Speaker Strobe, Amber Lens
SPSWL-CLR-ALERT	—	Speaker Strobe Clear Lens
—	SPSRL-SP	Speaker Strobe, Fuego
Accessories		
White	Red	Description
RFPW	RFP	7 in x 9.5 in Retrofit Plate
SBBSPWL	SBBSPRL	Surface Mount Back Box for Speakers and Speaker Strobes
TR-2W	TR-2	Wall Mount Trim Ring

#### Notes:

All -P models have a plain housing (no "FIRE" marking on the cover)



3825 Ohio Avenue • St. Charles, IL 60174  
 Phone: 800-SENSOR2 • Fax: 630-377-6495  
[www.systemsensor.com](http://www.systemsensor.com)

©2017 System Sensor.  
 Product specifications subject to change without notice. Visit [systemsensor.com](http://systemsensor.com)  
 for current product information, including the latest version of this data sheet.  
 AVDS86701 • 03/17



## UUMW.S4048 Speakers and Amplifiers for Fire-protective Signaling Systems

[Page Bottom](#)

### Speakers and Amplifiers for Fire-protective Signaling Systems

[See General Information for Speakers and Amplifiers for Fire-protective Signaling Systems](#)**SYSTEM SENSOR UNINCORPORATED, DIV OF HONEYWELL INTERNATIONAL INC**

S4048

3825 Ohio Ave  
Saint Charles, IL 60174-5467 USA

- #Speakers for indoor/damp use wall or ceiling mounting, Model(s) SPCRL, SPCWL, SPRL, SPWL
- #Speakers/strobes with rectangular enclosures, for indoor wall mounting use, Model(s) SPSRL-SP
- #Speakers/strobes with rectangular enclosures, for indoor wall/ceiling mouning use, Model(s) SPSRL, SPSRL-P
- #Speakers/strobes with rectangular enclosures, for indoor wall/ceiling mounting use, Model(s) SPSWL, SPSWL-ALERT, SPSWL-CLR-ALERT, SPSWL-P
- #Speakers/strobes with round enclosures, for indoor wall/ceiling mouning use, Model(s) SPSCRL, SPSCWL, SPSCWL-CLR-ALERT, SPSCWL-P, SPSCWL-SP
- Accessories, back boxes (rectangular), for indoor surface mounting use, "Spectralert Advance Series", Model(s) SBBSPR, SBBSPW
- Accessories, back boxes (round), for indoor surface mounting use, "Spectralert Advance Series", Model(s) SBBCR, SBBCW
- Accessories, backbox skirts (rectangular), for surface mounting, "Spectralert Advance Series", Model(s) SPBBS, SPBBSW
- Accessories, backbox skirts (reound), for surface mounting, "Spectralert Advance Series", Model(s) SPBBSC, SPBBSCW
- Accessories, retrofit plates, "Spectralert Advance Series", Model(s) RFP, RFPW
- Accessories, trim rings (rectangular), "Spectralert Advance Series", Model(s) TR, TRW
- Accessories, trim rings (round), "Spectralert Advance Series", Model(s) TRC, TRCW
- Accessory, Ceiling Tile Support Bracket, Model(s) SB-SPC8
- Speaker for indoor damp and dry use, suitable for use in air handling spaces, Model(s) SPCW8
- Speaker Strobes Only - Trim Rings - Ceiling Mount trim ring Round, Red,bulk pack-5, "L-Series", Model(s) TRC-2
- Speaker Strobes Only - Trim Rings - Ceiling Mount trim ring Round, White,bulk pack-5, "L-Series", Model(s) TRC-2W
- Speaker Strobes Only - Trim Rings - Wall-Mount trim ring Rectangular, Red, bulk pack-5, "L-Series", Model(s) TR-2
- Speaker Strobes Only - Trim Rings - Wall-Mount trim ring Rectangular, White,bulk pack-5, "L-Series", Model(s) TR-2W
- Speakers with rectangular enclosures, for indoor wall/ceiling mouning use, "Spectralert Advance Series", Model(s) SPR, SPRV
- Speakers with rectangular enclosures, for indoor wall/ceiling mounting use, "Spectralert Advance Series", Model(s) SPW, SPWV
- Speakers with round enclosures, for indoor wall/ceiling mouning use, "Spectralert Advance Series", Model(s) SPCR, SPCRV, SPCW, SPCWV
- Speakers, for indoor use, Model(s) SP200R, SP200W, SP201R, SP201W, SP300W, SP301R, SP301W
- Speakers, for indoor/outdoor use, Model(s) SP201K
- Speakers/Speaker Strobes Ceiling Bezel Kits - Ceiling Bezel Kit with AGENT red lettering, "L-Series", Model(s) BZSPWC-AG
- Speakers/Speaker Strobes Ceiling Bezel Kits - Ceiling Bezel Kit with AGENT white lettering, "L-Series", Model(s) BZSPRC-AG
- Speakers/Speaker Strobes Ceiling Bezel Kits - Ceiling Bezel Kit with ALERT red lettering, "L-Series", Model(s) BZSPWC-AL
- Speakers/Speaker Strobes Ceiling Bezel Kits - Ceiling Bezel Kit with ALERT white lettering, "L-Series", Model(s) BZSPRC-AL
- Speakers/Speaker Strobes Ceiling Bezel Kits - Ceiling Bezel Kit with EVAC red lettering, "L-Series", Model(s) BZSPWC-EV
- Speakers/Speaker Strobes Ceiling Bezel Kits - Ceiling Bezel Kit with EVAC white lettering, "L-Series", Model(s) BZSPRC-EV
- Speakers/Speaker Strobes Ceiling Bezel Kits - Ceiling Bezel Kit with FIRE red lettering, "L-Series", Model(s) BZSPWC-F
- Speakers/Speaker Strobes Ceiling Bezel Kits - Ceiling Bezel Kit with FIRE white lettering, "L-Series", Model(s) BZSPRC-F

# BAT Series Batteries

## Sealed Lead-Acid or Gell Cell



Power Supplies

### General

**BAT Series Batteries** feature a new part-numbering/listing system — providing an improved method of delivery for NOTIFIER-approved sealed lead-acid batteries for all your fire alarm system needs. Multiple brands of batteries are now offered under generic part numbers, reducing backorder situations and permitting us to deliver these products in a more timely fashion. NOTIFIER has approved the multiple brands listed below as possible product shipped for a given part number. Please note that any incoming orders for “PS Series” batteries will be converted to the equivalent BAT Series part numbers.



6933cov.jpg

### Features

- Provide secondary power for control panels.
- Sealed and maintenance-free.
- Overcharge protected.
- Easy handling with leakproof construction.
- Ruggedly constructed, high-impact case (ABS, polystyrene, or polypropylene, depending on models).
- Long service life.
- Compact design.

### Agency Listings and Approvals

The listings and approvals below apply to BAT Series Batteries. In some cases, certain modules may not be listed by certain approval agencies, or listing may be in process. Consult factory for latest listing status.

- **UL Recognized Components:** files MH19884 (*B & B Battery*), MH20567 (*UPG, previously Jolt*), MH20845 (*Power-Sonic*).

### Part Number Reference

CURRENT Part Number	BATTERY DESCRIPTION	ALTERNATES APPROVED: manufacturers and P/Ns shipped under BAT P/Ns
BAT-1250	12 V, 5 AH, sealed.	BP5-12 (B&B Battery); PS-1250 (Power-Sonic); SA1250 (Jolt) to be replaced with UB1250 (UPG).
BAT-1250	12 V, 5 AH, sealed.	BP5-12 (B&B Battery); PS-1250 (Power-Sonic); SA1250 (Jolt) to be replaced with UB1250 (UPG).
BAT-1270	12 V, 7 AH, sealed.	BP7-12 (B&B Battery); PS-1270 (Power-Sonic); SA1272 (Jolt) to be replaced with UB1270 (UPG).
BAT-12120	12 V, 12 AH, sealed.	BP12-12 (B&B Battery); PS-12120 (Power-Sonic); SA12120 (Jolt) to be replaced with UB12120 (UPG).
BAT-12180	12 V, 18 AH, sealed.	PS-12180 (Power-Sonic); SA12180 (Jolt) to be replaced with UB12180 (UPG).
BAT-12180	12 V, 18 AH, sealed.	PS-12180 (Power-Sonic); SA12180 (Jolt) to be replaced with UB12180 (UPG).
BAT-12260	12 V, 26 AH, sealed.	BP26-12 (B&B Battery); PS-12260 (Power-Sonic); SA12260 (Jolt) to be replaced with UB12260 (UPG).
BAT-12550	12 V, 55 AH, sealed.	PS-12550 (Power-Sonic); XSA12550 (Jolt) to be replaced with UB12550 (UPG).
BAT-12550	12 V, 55 AH, sealed.	PS-12550 (Power-Sonic); XSA12550 (Jolt) to be replaced with UB12550 (UPG).
BAT-121000	12 V, 100 AH, gell cell.	PS-121000 (Power-Sonic); XSA121000A (Jolt) to be replaced with UB121000 (UPG).

# POWER-SONIC

## Part Number Reference

1109t1.tbl

MODEL	Nominal Voltage V	Nominal Capacity @ 20 hr. rate A.H.	Discharge Current @20 hr. rate mA	DIMENSIONS									
				Width		Depth		Height		Height over terminal		Weight	
				in.	mm	in.	mm	in.	mm	in.	mm	lb.	kg.
PS-1250	12	5	250	3.54	90	2.76	70	4.02	102	4.21	107	4.1	1.9
PS-1270	12	7	325	5.94	151	2.56	65	3.7	94	3.86	98	5.7	2.6
PS-12120	12	12	600	5.94	151	3.86	98	3.7	94	3.86	98	8.8	4
PS-12180	12	18	875	7.13	181	2.99	76	6.57	167	6.57	167	12.8	5.8
PS-12250	12	25	1300	6.89	175	6.54	166	4.92	125	4.92	125	18.7	8.5
PS-12550	12	55	3000	10.25	260	6.6	168	8.2	208	9.45	240	39.7	18
PS-121000	12	100	5000	12	305	6.6	168	8.2	208	9.45	240	65.7	29.8

**Characteristic Discharge Curves**

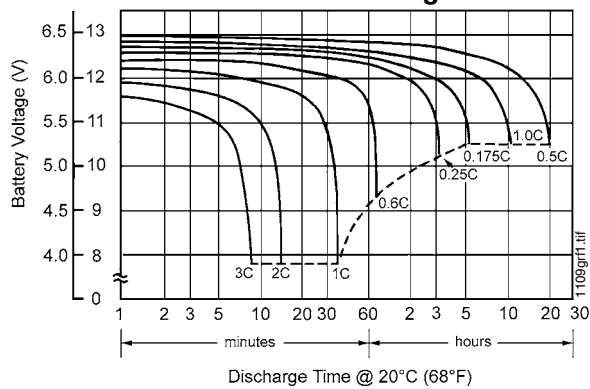

**Effect of Temperature on Capacity**

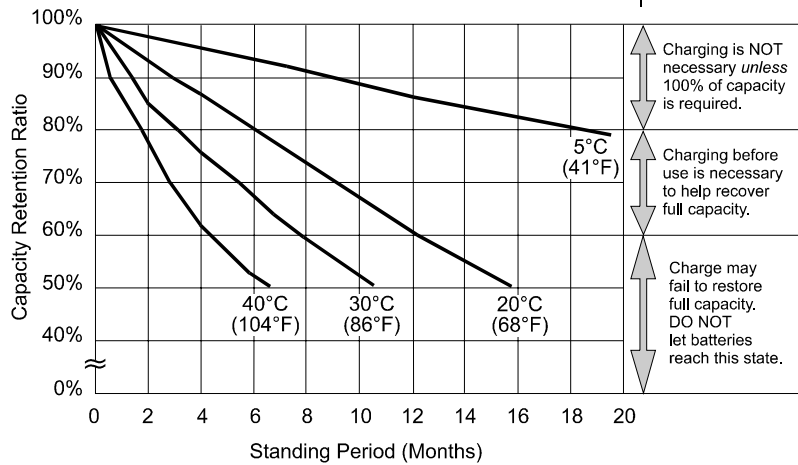
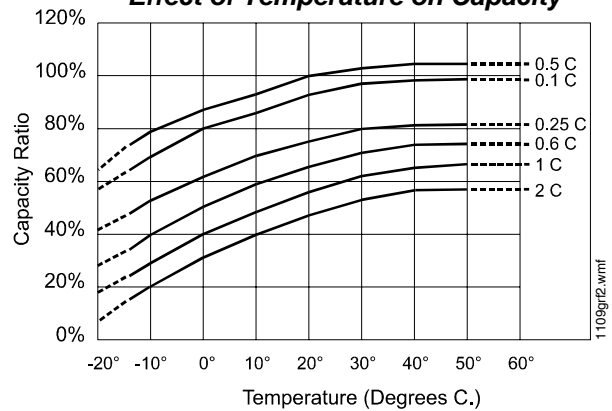

**at left:  
PS-121000  
Shelf-Life  
and Storage**

Charging is NOT necessary unless 100% of capacity is required.

Charging before use is necessary to help recover full capacity.

Charge may fail to restore full capacity. DO NOT let batteries reach this state.

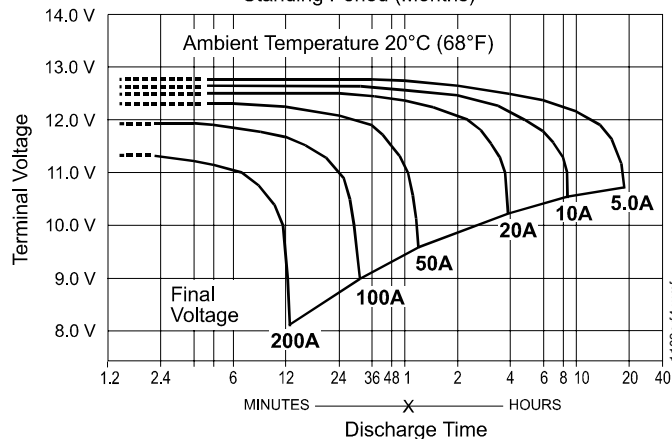

**at left:  
PS-121000  
Discharge  
Characteristics**

## B & B BATTERY

Model	V	Nominal Capacity (AH)				Weight		Terminal				Dimensions							
								Standard		Optional		L		W		H		TH	
		20 hr	10 hr	5 hr	1 hr	kg	lbs	Type	Pos.	Type	Pos.	mm	in	mm	in	mm	in	mm	in
BP5-12	12	5.00	4.75	4.25	3.00	1.86	4.10	T1	3	T2		90	3.54	70	2.76	102	4.02	106	4.17
BP7-12	12	7.00	6.65	5.95	4.20	2.60	5.73	T2	5	T1		151	5.94	65	2.56	93	3.66	98	3.86
BP12-12	12	12.00	11.40	10.20	7.20	4.03	8.89	B1	5	T1		151	5.94	98	3.86	94	3.70	98	3.86
BP26-12	12	26.00	24.70	22.10	15.60	9.40	20.73	B1	7	T2.11	9	175	6.89	166	6.54	125	4.92	125	4.92

### Charging Procedure

Application	Charging method	Charging voltage at 20°C (V/cell)	Temperature compensation coefficient of charging voltage (mV/°C/cell)	Maximum charging current (CA)	Charging time 0.1 CA, 20°C (h)		Temp (°C)
					100% discharge	50% discharge	
For standby power source	Constant voltage and constant current charging (with current restriction)	2.25 ~ 2.30	- 3	0.3	24	20	0 - 40°C (32 ~ 104°F)
For cycle service		2.40 ~ 2.50	- 4	0.3	16	10	

Temperature compensation of charging voltage is not needed when using the batteries within 5°C to 35°C range.

Final Voltage	Discharge Time: for Model BP5-12								
	5 min	10 min	15 min	30 min	1 hr	3 hr	5 hr	10 hr	20 hr
	Battery Output Power (W): for Model BP5-12								
10.80 V	180.8	133.1	106.6	63.5	36.39	14.57	10.05	5.62	2.94
10.50 V	209.2	144.2	111.5	65.9	37.48	14.87	10.20	5.70	3.00
10.20 V	222.3	149.4	115.0	67.4	38.16	15.00	10.26	5.73	3.01
9.90 V	232.3	152.9	117.6	68.3	38.61	15.10	10.29	5.75	3.02
9.60 V	240.0	156.0	120.0	69.0	39.0	15.20	10.32	5.75	3.02

**Constant Power Discharge Characteristics at 25°C/77°F for BP5-12**

Final Voltage	Discharge Time: for Model BP7-12								
	5 min	10 min	15 min	30 min	1 hr	3 hr	5 hr	10 hr	20 hr
	Battery Output Power (W): for Model BP7-12								
10.80 V	253.1	186.3	149.3	88.8	50.95	20.40	14.07	7.86	4.11
10.50 V	292.9	201.8	156.2	92.2	52.47	20.81	14.28	7.98	4.20
10.20 V	311.2	209.1	161.0	94.3	53.42	21.00	14.36	8.02	4.22
9.90 V	325.2	214.1	164.7	95.6	54.06	21.15	14.41	8.04	4.23
9.60 V	336.0	218.4	168.0	96.6	54.60	21.27	14.45	8.04	4.23

**Constant Power Discharge Characteristics at 25°C/77°F for BP7-12**

Final Voltage	Discharge Time: for Model BP12-12								
	5 min	10 min	15 min	30 min	1 hr	3 hr	5 hr	10 hr	20 hr
	Battery Output Power (W): for Model BP12-12								
10.80 V	433.9	319.4	256.0	152.3	87.34	34.98	24.12	13.48	7.05
10.50 V	502.2	346.0	267.7	158.1	89.96	35.68	24.48	13.68	7.20
10.20 V	533.6	358.5	276.0	161.7	91.57	36.00	24.61	13.75	7.23
9.90 V	557.5	367.1	282.4	164.0	92.67	36.25	24.70	13.79	7.25
9.60 V	576.0	374.4	288.0	165.6	93.60	36.47	24.77	13.79	7.25

**Constant Power Discharge Characteristics at 25°C/77°F for BP12-12**

Final Voltage	Discharge Time: for Model BP26-12								
	5 min	10 min	15 min	30 min	1 hr	3 hr	5 hr	10 hr	20 hr
	Battery Output Power (W): for Model BP26-12								
10.80 V	940.0	692.0	554.6	330.0	189.23	75.79	52.25	29.20	15.26
10.50 V	1088.0	749.7	580.0	342.5	194.91	77.30	53.04	29.64	15.60
10.20 V	1156.0	776.7	598.0	350.3	198.41	78.00	53.33	29.79	15.67
9.90 V	1208.0	795.3	611.8	355.2	200.79	78.54	53.52	29.88	15.71
9.60 V	1248.0	811.2	624.0	358.8	202.80	79.01	53.68	29.88	15.71

**Constant Power Discharge Characteristics at 25°C/77°F for BP26-12**

# B & B BATTERY

**BP5-12 Battery Discharge Characteristics (25°C/77°F)**

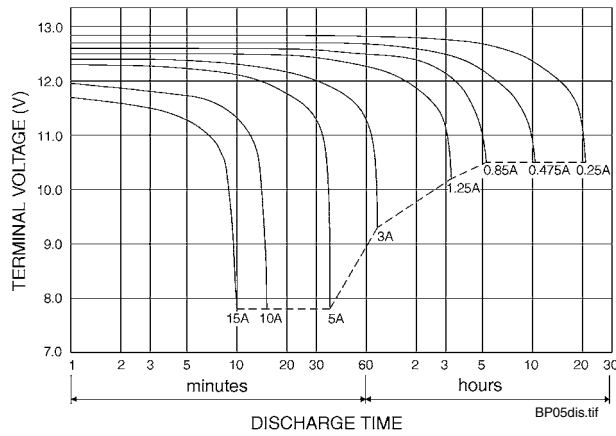

**BP7-12 Battery Discharge Characteristics (25°C/77°F)**

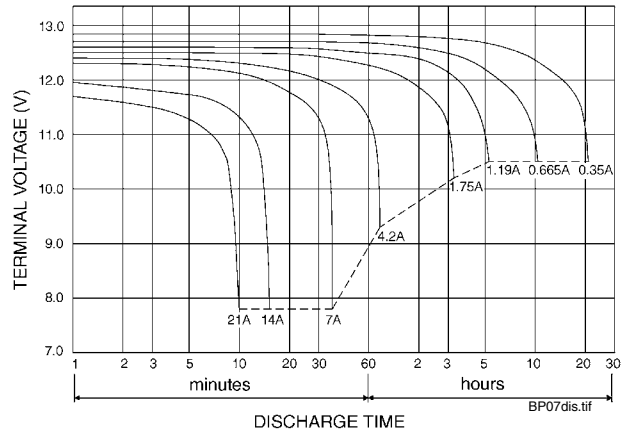

**BP12-12 Battery Discharge Characteristics (25°C/77°F)**

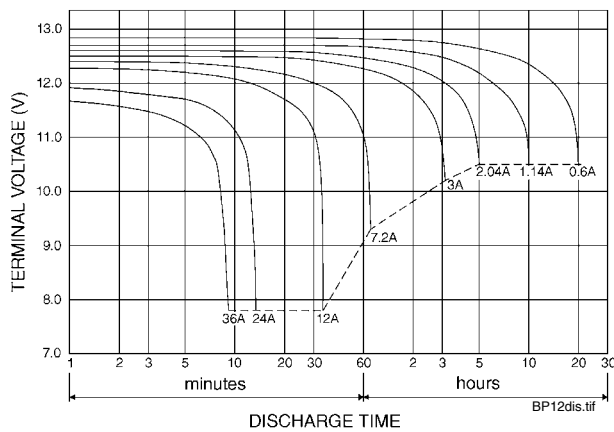

**BP26-12 Battery Discharge Characteristics (25°C/77°F)**

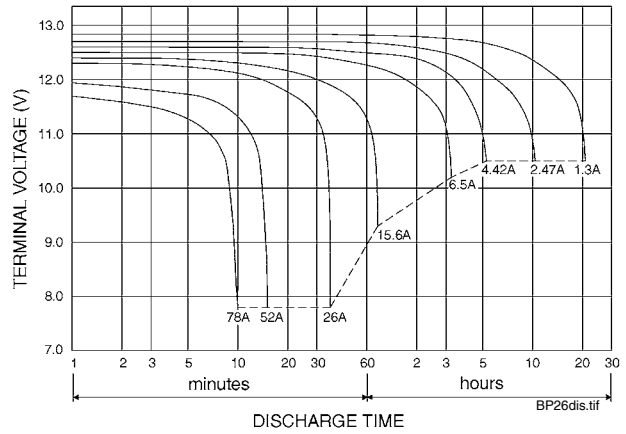

**BP05-12**



**BP12-12**



**BP26-12**



# UPG BATTERY

UB1250 has the same specifications as previous Jolt SA1250; SA1272 to be replaced with UB1270 (specs/diagrams pending).

## UB1250 (previously SA1250) Diagrams

UB1250/SA1250 discharge current vs. time

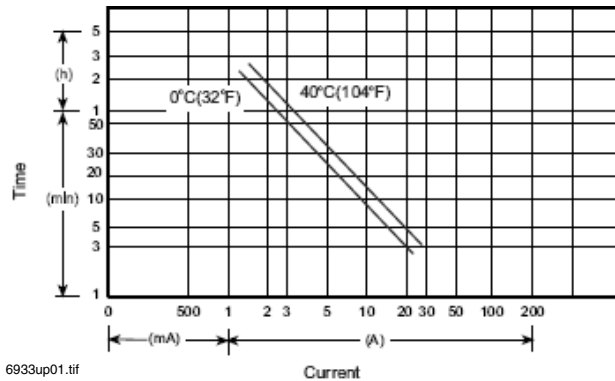

6933up01.tif

UB1250/SA1250 discharge characteristics (25°C/77°F)

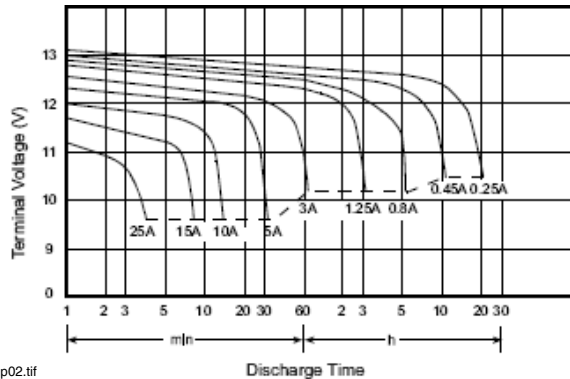

6933up02.tif

## UB1250, SA1250 Specifications

- Nominal voltage: 12 V.
- Nominal capacity (20 hr): 5.0 AH.
- Dimensions: total height 107 mm (4.21"); container height 101 mm (3.98"); length 90 mm (3.54"); width 70 mm (2.76").
- Weight: approximately 1.83 kg (4.03 lbs).
- Container material: UL94HB ABS, UL94V-0 ABS.
- Internal resistance (25°C, 77°F): ~ 32 m.
- Discharge capacity under different temperatures:
  - 40°C: ~ 102%
  - 25°C: ~ 100%
  - 0°C: ~ 85%
- Capacity 25°C/77°F:
  - 20 hr @ 0.25 A: 5.0 AH.
  - 5 hr @ 0.8 A: 4.0 AH.
  - 1 hr @ 3.0 A: 3.0 AH.
  - 1 C @ 5.0 A: 2.5 AH.
- Charging voltage (25°C, 77°F):
  - Standby use: 13.65 V ± 0.15 V.
  - Cycle use: 14.7 V ± 0.3 V.
- Maximum discharge current: 60 A (5 sec).
- Maximum charging current: 1.5 A.
- Self-discharge residual capacity (25°C, 77°F):
  - After 3 months: ~ 90%.
  - After 6 months: ~ 82%.
  - After 12 months: ~ 70%.

## SA1272 Diagrams

SA1272 discharge current vs. time

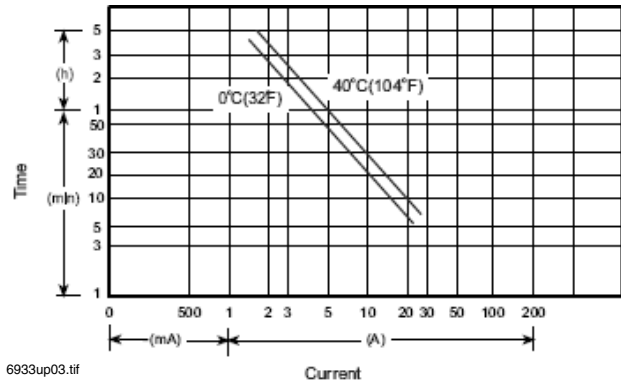

6933up03.tif

SA1272 discharge characteristics (25°C/77°F)

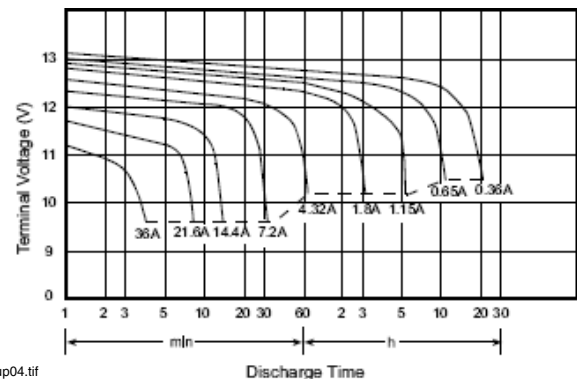

6933up04.tif

## SA1272 Specifications

- Nominal voltage: 12 V.
- Nominal capacity (20 hr): 7.2 AH.
- Dimensions: total height 100 mm (3.94"); container height 94 mm (3.70"); length 151 mm (5.95"); width 65 mm (2.56").
- Weight: approximately 2.66 kg (5.85 lbs).
- Container material: UL94HB ABS, UL94V-0 ABS.
- Internal resistance (25°C, 77°F): ~ 22 m.
- Discharge capacity under different temperatures:
  - 40°C: ~ 102%
  - 25°C: ~ 100%
  - 0°C: ~ 85%
- Capacity 25°C/77°F:
  - 20 hr @ 0.36 A: 7.2 AH.
  - 5 hr @ 1.15 A: 5.76 AH.
  - 1 hr @ 4.32 A: 4.32 AH.
  - 1 C @ 7.2 A: 3.6 AH.
- Charging voltage (25°C, 77°F):
  - Standby use: 13.65 V ± 0.15 V.
  - Cycle use: 14.7 V ± 0.3 V.
- Maximum discharge current: 90 A (5 sec).
- Maximum charging current: 2.16 A.
- Self-discharge residual capacity (25°C, 77°F):
  - After 3 months: ~ 90%.
  - After 6 months: ~ 82%.
  - After 12 months: ~ 70%.

# UPG BATTERY

Same specifications as previous Jolt models; packaging and part numbers are the only changes.

## UB12120 (was SA12120) Diagrams

UB12120/SA12120 discharge current vs. time

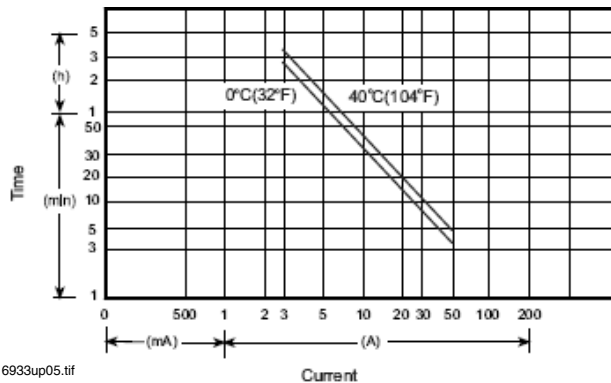

6933up05.tif

UB12120/SA12120 discharge characteristics (25°C/77°F)

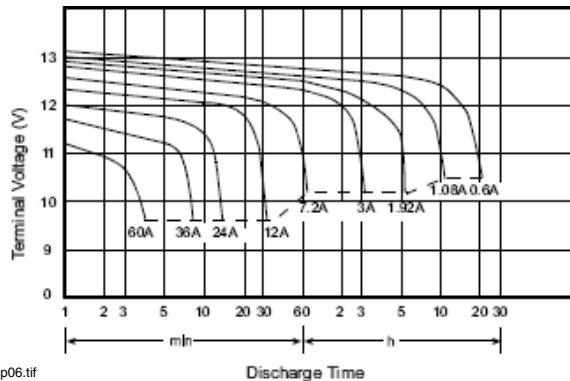

6933up06.tif

## UB12120, SA12120 Specifications

- Nominal voltage: 12 V.
  - Nominal capacity (20 hr): 12.0 AH.
  - Dimensions: total height 100 mm (3.94"); container height 94 mm (3.70"); length 151 mm (5.95"); width 98 mm (3.86").
  - Weight: approximately 4.10 kg (9.04 lbs).
  - Container material: UL94HB ABS, UL94V-0 ABS.
  - Internal resistance (25°C, 77°F): ~ 14 m.
  - Discharge capacity under different temperatures:
    - 40°C: ~ 102%
    - 25°C: ~ 100%
    - 0°C: ~ 85%
  - Capacity 25°C/77°F:
    - 20 hr @ 0.6 A: 12.0 AH.
    - 5 hr @ 1.92 A: 9.6 AH.
    - 1 hr @ 7.2 A: 7.2 AH.
    - 1 C @ 12.0 A: 6.0 AH.
  - Charging voltage (25°C, 77°F):
    - Standby use: 13.65 V ± 0.15 V.
    - Cycle use: 14.7 V ± 0.3 V.
- Maximum discharge current: 120 A (5 sec).  
 Maximum charging current: 3.6 A.  
 Self-discharge residual capacity (25°C, 77°F):
- After 3 months: ~ 90%.
  - After 6 months: ~ 82%.
  - After 12 months: ~ 70%.

## UB12180 (was SA12180) Diagrams

UB12180/SA12180 discharge current vs. time

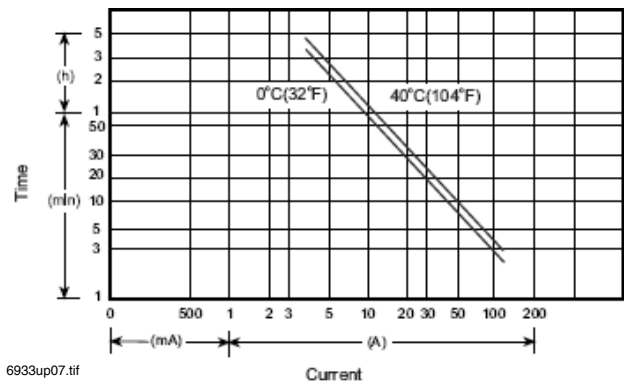

6933up07.tif

UB12180/SA12180 discharge characteristics (25°C/77°F)

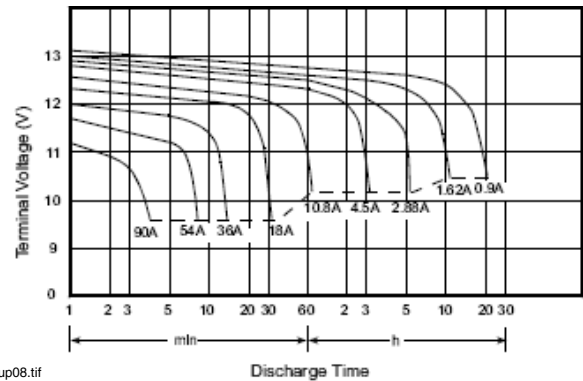

6933up08.tif

## UB12180, SA12180 Specifications

- Nominal voltage: 12 V.
  - Nominal capacity (20 hr): 18.0 AH.
  - Dimensions: total height 167 mm (6.58"); container height 167 mm (6.58"); length 181 mm (7.13"); width 76 mm (2.29").
  - Weight: approximately 6.06 kg (13.36 lbs).
  - Container material: UL94HB ABS, UL94V-0 ABS.
  - Internal resistance (25°C, 77°F): ~ 13 m.
  - Discharge capacity under different temperatures:
    - 40°C: ~ 102%
    - 25°C: ~ 100%
    - 0°C: ~ 85%
  - Capacity 25°C/77°F:
    - 20 hr @ 0.9 A: 18.0 AH.
    - 5 hr @ 2.88 A: 14.4 AH.
    - 1 hr @ 10.8 A: 10.8 AH.
    - 1 C @ 18.0 A: 9.0 AH.
  - Charging voltage (25°C, 77°F):
    - Standby use: 13.65 V ± 0.15 V.
    - Cycle use: 14.7 V ± 0.3 V.
- Maximum discharge current: 300 A (5 sec).  
 Maximum charging current: 5.4 A.  
 Self-discharge residual capacity (25°C, 77°F):
- After 3 months: ~ 90%.
  - After 6 months: ~ 82%.
  - After 12 months: ~ 70%.

# UPG BATTERY

Same specifications as previous Jolt models; packaging and part numbers are the only changes.

## UB12260 (was SA12260) Diagrams

UB12260/SA12260 discharge current vs. time

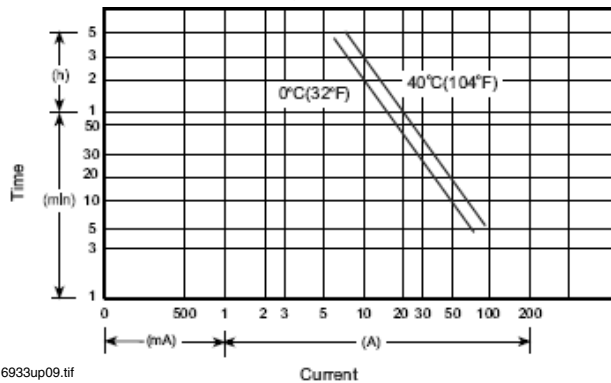

6933up09.tif

UB12260/SA12260 discharge characteristics (25°C/77°F)

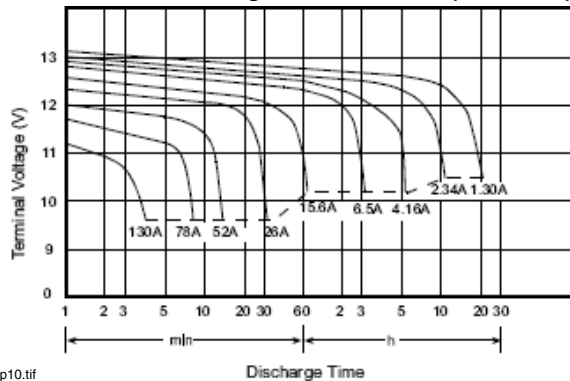

6933up10.tif

## UB12260, SA12260 Specifications

- Nominal voltage: 12 V.
- Nominal capacity (20 hr): 26.0 AH.
- Dimensions: total height 125 mm (4.92"); container height 125 mm (4.92"); length 166 mm (6.54"); width 175 mm (6.89").
- Weight: approximately 8.80 kg (19.40 lbs).
- Container material: UL94HB ABS, UL94V-0 ABS.
- Internal resistance (25°C, 77°F): ~ 10 m.
- Discharge capacity under different temperatures:
  - 40°C: ~ 102%
  - 25°C: ~ 100%
  - 0°C: ~ 85%
- Capacity 25°C/77°F:
  - 20 hr @ 1.3 A: 26.0 AH.
  - 5 hr @ 4.16 A: 20.8 AH.
  - 1 hr @ 15.6 A: 15.6 AH.
  - 1 C @ 26.0 A: 13.0 AH.
- Charging voltage (25°C, 77°F):
  - Standby use: 13.65 V ± 0.15 V.
  - Cycle use: 14.7 V ± 0.3 V.
- Maximum discharge current: 300 A (5 sec).
- Maximum charging current: 7.8 A.
- Self-discharge residual capacity (25°C, 77°F):
  - After 3 months: ~ 90%.
  - After 6 months: ~ 82%.
  - After 12 months: ~ 70%.

## UB12550 (was SA12550) Diagrams

UB12550/SA12550 discharge current vs. time

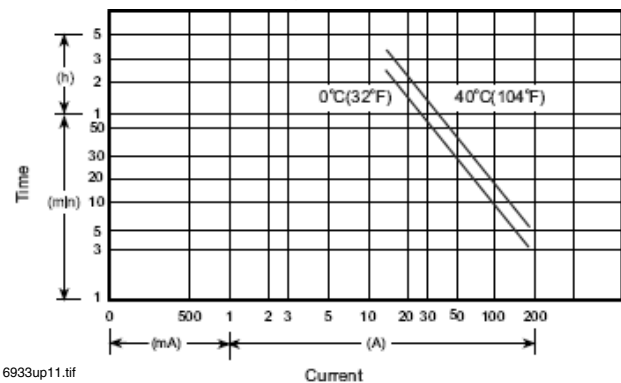

6933up11.tif

UB12550/SA12550 discharge characteristics (25°C/77°F)

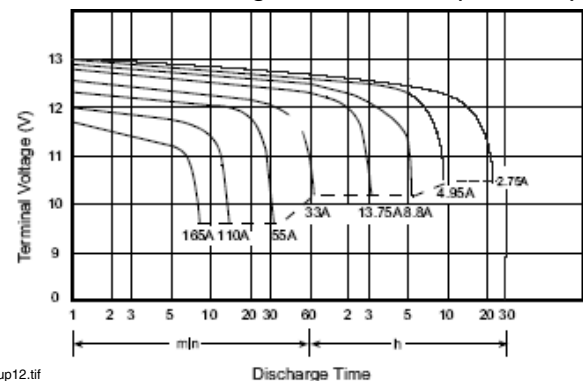

6933up12.tif

## UB12550, SA12550 Specifications

- Nominal voltage: 12 V.
- Nominal capacity (20 hr): 55.0 AH.
- Dimensions: total height 234.5 mm (9.23"); container height 216.5 mm (8.52"); length 229 mm (9.02"); width 138 mm (5.43").
- Weight: approximately 19.0 kg (41.8 lbs).
- Container material: UL94HB ABS, UL94V-0 ABS.
- Internal resistance (25°C, 77°F): ~ 8 m.
- Discharge capacity under different temperatures:
  - 40°C: ~ 102%
  - 25°C: ~ 100%
  - 0°C: ~ 85%
- Capacity 25°C/77°F:
  - 20 hr @ 2.75 A: 55.0 AH.
  - 5 hr @ 8.8 A: 44.0 AH.
  - 1 hr @ 33.0 A: 33.0 AH.
  - 1 C @ 55.0 A: 27.5 AH.
- Charging voltage (25°C, 77°F):
  - Standby use: 13.65 V ± 0.15 V.
  - Cycle use: 14.7 V ± 0.3 V.
- Maximum discharge current: 600 A (5 sec).
- Maximum charging current: 16.5 A.
- Self-discharge residual capacity (25°C, 77°F):
  - After 3 months: ~ 90%.
  - After 6 months: ~ 82%.
  - After 12 months: ~ 70%.

# UPG BATTERY

Same specifications as previous Jolt models; packaging and part numbers are the only changes.

## UB121000 (XSA121000A) Diagrams

UB121000/XSA121000A discharge current vs. time

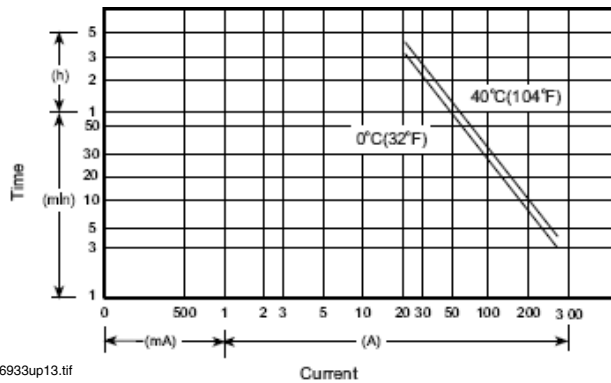

6933up13.tif

UB121000/XSA121000A discharge characteristics (25°C/77°F)

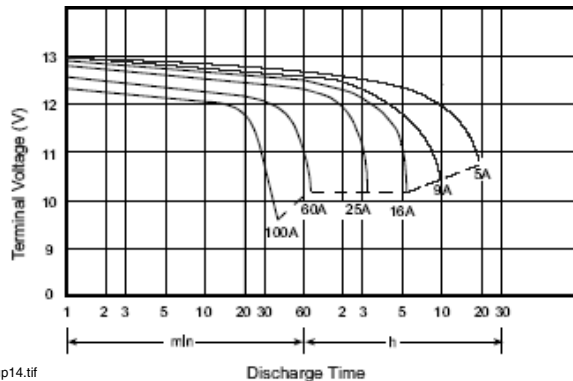

6933up14.tif

## UB121000 (XSA121000A) Diagrams

- Nominal voltage: 12 V.
- Nominal capacity (20 hr): 100.0 AH.
- Dimensions: total height 221 mm (8.70"); container height 214 mm (8.43"); length 329 mm (12.95"); width 172 mm (6.77").
- Weight: approximately 34.00 kg (74.8 lbs).
- Container material: UL94HB ABS, UL94V-0 ABS.
- Internal resistance (25°C, 77°F): ~ 6.5 m.
- Discharge capacity under different temperatures:
  - 40°C: ~ 102%
  - 25°C: ~ 100%
  - 0°C: ~ 85%
- Capacity 25°C/77°F:
  - 20 hr @ 5.0 A: 100.0 AH.
  - 5 hr @ 16.0 A: 80.0 AH.
  - 1 hr @ 60.0 A: 60.0 AH.
  - 1 C @ 100.0 A: 50.0 AH.
- Charging voltage (25°C, 77°F):
  - Standby use: 13.65 V ± 0.15 V.
  - Cycle use: 14.7 V ± 0.3 V.
- Maximum discharge current: 600 A (5 sec).
- Maximum charging current: 30 A.
- Self-discharge residual capacity (25°C, 77°F):
  - After 3 months: ~ 90%.
  - After 6 months: ~ 82%.
  - After 12 months: ~ 70%.

## UPG Summary Diagrams

Summary discharge characteristics

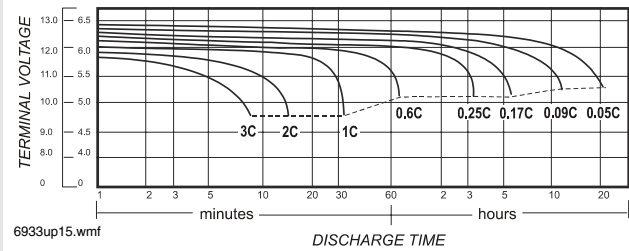

Summary discharge current vs. time curve (25°C/77°F)

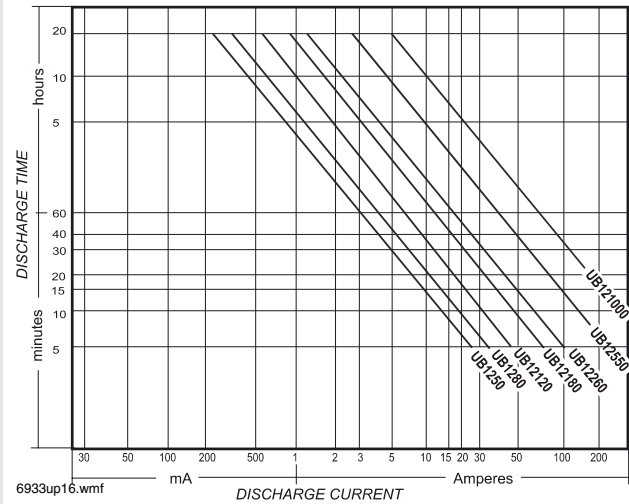

6933up16.wmf



6933ub1280.jpg



6933ub12260.jpg

# UPG BATTERY

Same specifications as previous Jolt models;  
packaging and part numbers are the only changes.

## Charging Procedure: UPG Battery

Application	Charging method	Charging voltage at 25°C (V/cell)	Temperature compensation coefficient of charging voltage (mV/°C/cell)	Maximum charging current (CA)	Charging time 0.1 CA, 25°C (h)		Temp (°C)
					100% discharge	50% discharge	
For standby power source	Constant voltage and constant current charging (with current restriction)	2.25 ~ 2.30	- 3.3 (-1.8 mV/°F/cell)	0.3	T <sup>3</sup> 24	T <sup>3</sup> 20	0 – 40°C (32 – 104°F)
For cycle service		2.40 ~ 2.50	- 5 (-2.8 mV/°F/cell)	0.3	16 < T < 24	10 < T < 24	

Temperature compensation of charging voltage is not needed when using the batteries within 5°C to 35°C range.

---

**NOTIFIER®** is a registered trademark of Honeywell International Inc.  
Batteries display trademarks of the manufacturer.  
©2009 by Honeywell International Inc. All rights reserved. Unauthorized use  
of this document is strictly prohibited.

---



This document is not intended to be used for installation purposes.  
We try to keep our product information up-to-date and accurate.  
We cannot cover all specific applications or anticipate all requirements.  
All specifications are subject to change without notice.

For more information, contact Notifier. Phone: (203) 484-7161, FAX: (203) 484-7118.  
[www.notifier.com](http://www.notifier.com)



## BAZR2.MH20845 Batteries, Standby - Component

[Page Bottom](#)

### Batteries, Standby - Component

[See General Information for Batteries, Standby - Component](#)

**POWER-SONIC CORP**

7550 PANASONIC WAY  
SAN DIEGO, CA 92154 USA

MH20845

Model	Max Discharge Rate		Min Charge Rate		Operating Range °C	Battery Case Flame Rating	External Battery Supply Enclosure Investigated For
	Amps	Hr	Amps	Hr			
<b>Batteries, sealed cell lead-acid.</b>							
PS-612	—	—	—	—	—	HB	—
PS-630	—	—	—	—	—	HB	—
PS-640	—	—	—	—	—	HB	—
PS-6100	—	—	—	—	—	HB	—
PS-1208	—	—	—	—	—	HB	—
PS-1212	—	—	—	—	—	—	—
PS-1220	—	—	—	—	—	HB	—
PS-1230	—	—	—	—	—	HB	—
PS-1270	—	—	—	—	—	HB	—
PS-12120	—	—	—	—	—	HB	—
PS-12260	—	—	—	—	—	HB	—
PS-12550	—	—	—	—	—	HB	—
PS-12750	—	—	—	—	—	HB	—
PS-121000	—	—	—	—	—	HB	—
PS-632	—	—	—	—	—	—	—
PS1223	—	—	—	—	—	—	—
PS-1290	—	—	—	—	—	—	—
PS-445	—	—	—	—	—	HB	—
PS-625	—	—	—	—	—	HB	—
PS-1228	—	—	—	—	—	HB	—
PS-1229	—	—	—	—	—	HB	—
PSH-655	—	—	—	—	—	HB	—
PS-1221	—	—	—	—	—	—	—
PS-1221-S	—	—	—	—	—	—	—
PG12V28	—	—	—	—	—	—	—
PG12V42	—	—	—	—	—	—	—

PG12V55	—	—	—	—	—	HB	—
PG12V65	—	—	—	—	—	HB	—
PG12V75	—	—	—	—	—	HB	—
PG12V75T	—	—	—	—	—	HB	—
PG12V92	—	—	—	—	—	—	—
PG12V103	—	—	—	—	—	—	—
PG12V120	—	—	—	—	—	—	—
PG12V140	—	—	—	—	—	—	—
PG12V150	—	—	—	—	—	HB	—
PG12V200	—	—	—	—	—	HB	—
PS-1272	—	—	—	—	—	HB	—
PS-1272 F1	—	—	—	—	—	—	—
PS-1272 F2	—	—	—	—	—	—	—
PS-12180	—	—	—	—	—	HB	—
PSH-12180	—	—	—	—	—	—	—
PS-6580	—	—	—	—	—	—	—
PSH-655	—	—	—	—	—	HB	—
PS-6200B	—	—	—	—	—	HB	—
PG-6V210	—	—	—	—	—	HB	—
PS-12350	—	—	—	—	—	HB	—
PS-4100	—	—	—	—	—	HB	—
PS-605WL	—	—	—	—	—	HB	—
PSG-450	—	—	—	—	—	HB	—
PSG-480	—	—	—	—	—	HB	—
PSG-625	—	—	—	—	—	HB	—
PSG-650	—	—	—	—	—	HB	—
PSG-680	—	—	—	—	—	HB	—
PS-445	—	—	—	—	—	HB	—
PS-490	—	—	—	—	—	HB	—
PS-610	—	—	—	—	—	HB	—
PS-612	—	—	—	—	—	HB	—
PS-628	—	—	—	—	—	HB	—
PS-630	—	—	—	—	—	—	—
PS-640F1	—	—	—	—	—	HB	—
PS-650LS	—	—	—	—	—	HB	—
PS-665P	—	—	—	—	—	HB	—
PS-670	—	—	—	—	—	—	—
PS-682F1	—	—	—	—	—	HB	—
PS-6100F1	—	—	—	—	—	HB	—
PS-6100F2	—	—	—	—	—	HB	—
PS-6120FP	—	—	—	—	—	HB	—
PS-6120TS	—	—	—	—	—	HB	—

PS-6120TH	—	—	—	—	—	HB	—
PS-6200	—	—	—	—	—	HB	—
PS-6360F2	—	—	—	—	—	—	—
PS-6360NB	—	—	—	—	—	—	—
PS-6580	—	—	—	—	—	—	—
PS-832	—	—	—	—	—	—	—
PS-1212	—	—	—	—	—	—	—
PS-1220	—	—	—	—	—	—	—
PS-1227	—	—	—	—	—	HB	—
PS-1230	—	—	—	—	—	HB	—
PS-1238	—	—	—	—	—	HB	—
PS-1250F1	—	—	—	—	—	HB	—
PS-1270F1	—	—	—	—	—	—	—
PS-1270F2	—	—	—	—	—	—	—
PS-1290F2	—	—	—	—	—	—	—
PS-12120F2	—	—	—	—	—	—	—
PS-12180F2	—	—	—	—	—	HB	—
PS-12260NB	—	—	—	—	—	HB	—
PS-12280NB	—	—	—	—	—	HB	—
PS-12330NB	—	—	—	—	—	—	—
PS-12400NB	—	—	—	—	—	HB	—
PS-12400	—	—	—	—	—	HB	—
PS-12550U	—	—	—	—	—	HB	—
PS-12750U	—	—	—	—	—	HB	—
PS-121000U	—	—	—	—	—	—	—
PS-121100B	—	—	—	—	—	—	—
PS-121400B	—	—	—	—	—	—	—
PSH-1255F2	—	—	—	—	—	HB	—
PSH-12100F2	—	—	—	—	—	—	—
PS-650L	—	—	—	—	—	HB	—
PS-6100F2	—	—	—	—	—	HB	—
PS-1250F2	—	—	—	—	—	HB	—
PS-12180NB	—	—	—	—	—	HB	—
PSH-1280F2	—	—	—	—	—	—	—
PSH-12100	—	—	—	—	—	—	—
PS-1270PBR	—	—	—	—	—	—	—
PS-12140PBR	—	—	—	—	—	—	—
SA-6100	—	—	—	—	—	HB	—
SA-12100	—	—	—	—	—	HB	—
SA-24100	—	—	—	—	—	HB	—
PS-1282	—	—	—	—	—	HB	—
PS-12100	—	—	—	—	—	HB	—

PS-1290H	—	—	—	—	—	—	—
PS-1290F2	—	—	—	—	—	—	—
PS-12330	—	—	—	—	—	—	—
<b>Sealed cell, lead acid batteries with pressure release vents.</b>							
DCG12-15	—	—	—	—	—	HB	—
DCG12-26	—	—	—	—	—	HB	—
DCG12-31	—	—	—	—	—	HB	—
DCG12-38	—	—	—	—	—	HB	—
DCG12-50	—	—	—	—	—	HB	—
DCG12-70	—	—	—	—	—	HB	—
DCG12-100	—	—	—	—	—	—	—
PS-1208WL	—	—	—	—	—	HB	—
PS-1223	—	—	—	—	—	HB	—
PS1229	—	—	—	—	—	HB	—
PSG-12170 B	—	—	—	—	—	HB	—
120072260208, 120072340208	—	—	—	—	—	HB	—
PSG-12400 B	—	—	—	—	—	HB	—
PSG-121000 B	—	—	—	—	—	HB	—
PSG-121100 B	—	—	—	—	—	HB	—
PSG-12260 B	—	—	—	—	—	HB	—
PSG12310 B	—	—	—	—	—	—	—
PSG-12550 B	—	—	—	—	—	HB	—
PSG-12700 B	—	—	—	—	—	HB	—
PSG-122000 B	—	—	—	—	—	HB	—
PSG-121500 B	—	—	—	—	—	HB	—
PS-122000	—	—	—	—	—	HB	—
060012260208	—	—	—	—	—	HB	—
060065290208	—	—	—	—	—	HB	—
060100260208	—	—	—	—	—	HB	—
120012260208	—	—	—	—	—	HB	—
120070260208	—	—	—	—	—	HB	—
120070260215	—	—	—	—	—	HB	—
120120340215	—	—	—	—	—	HB	—
120120340208	—	—	—	—	—	HB	—
120182340208	—	—	—	—	—	HB	—
120055340708	—	—	—	—	—	V-0	—
120180400708	—	—	—	—	—	V-0	—
120028290208	—	—	—	—	—	HB	—
<b>Sealed cell, lead acid batteries with pressure release vents.</b>							
120350400208	—	—	—	—	—	HB	—
120070340208	—	—	—	—	—	HB	—
120400400208	—	—	—	—	—	HB	—

120040260208	—	—	—	—	—	HB	—
120050260208	—	—	—	—	—	HB	—
120182400208	—	—	—	—	—	HB	—
120029260208	—	—	—	—	—	HB	—
120020260208	—	—	—	—	—	HB	—
060100340208	—	—	—	—	—	HB	—
120050340208	—	—	—	—	—	HB	—
060082260208	—	—	—	—	—	HB	—
020060260208	—	—	—	—	—	HB	—
060360340208	—	—	—	—	—	HB	—
120021260208	—	—	—	—	—	HB	—
PSH 655 FR	—	—	—	—	—	HB	—
PSH 1255 F2 FR	—	—	—	—	—	HB	—
PSH 1280 F2 FR	—	—	—	—	—	HB	—
PSH 12100 F2 FR	—	—	—	—	—	HB	—
PSH 12180 F2/NB FR	—	—	—	—	—	HB	—

Marking: Company name and model number on battery case or cover.

Last Updated on 2010-04-02

[Questions?](#)

[Print this page](#)

[Notice of Disclaimer](#)

[Page Top](#)

[Copyright © 2011 Underwriters Laboratories Inc.®](#)

The appearance of a company's name or product in this database does not in itself assure that products so identified have been manufactured under UL's Follow-Up Service. Only those products bearing the UL Mark should be considered to be Listed and covered under UL's Follow-Up Service. Always look for the Mark on the product.

UL permits the reproduction of the material contained in the Online Certification Directory subject to the following conditions: 1. The Guide Information, Designs and/or Listings (files) must be presented in their entirety and in a non-misleading manner, without any manipulation of the data (or drawings). 2. The statement "Reprinted from the Online Certifications Directory with permission from Underwriters Laboratories Inc." must appear adjacent to the extracted material. In addition, the reprinted material must include a copyright notice in the following format: "Copyright © 2011 Underwriters Laboratories Inc.®"

An independent organization working for a safer world with integrity, precision and knowledge.





